

9-2015

# Simple Groups and Related Topics

Manal Abdulkarim Marouf Ms.

California State University - San Bernardino, nnn\_nonaa@hotmail.com

Follow this and additional works at: <http://scholarworks.lib.csusb.edu/etd>

---

## Recommended Citation

Marouf, Manal Abdulkarim Ms., "Simple Groups and Related Topics" (2015). *Electronic Theses, Projects, and Dissertations*. Paper 239.

This Thesis is brought to you for free and open access by the Office of Graduate Studies at CSUSB ScholarWorks. It has been accepted for inclusion in Electronic Theses, Projects, and Dissertations by an authorized administrator of CSUSB ScholarWorks. For more information, please contact [scholarworks@csusb.edu](mailto:scholarworks@csusb.edu).

SIMPLE GROUPS AND RELATED TOPICS

---

A Thesis

Presented to the

Faculty of

California State University,

San Bernardino

---

In Partial Fulfillment

of the Requirements for the Degree

Master of Arts

in

Mathematics

---

by

Manal Abdulkarim Marouf

September 2015

SIMPLE GROUPS AND RELATED TOPICS

---

A Thesis  
Presented to the  
Faculty of  
California State University,  
San Bernardino

---

by  
Manal Abdulkarim Marouf

September 2015

Approved by:

---

Dr. Zahid Hasan, Committee Chair

---

Date

---

Dr. Joseph Chavez, Committee Member

---

Dr. Ilseop Han, Committee Member

---

Dr. Charles Stanton, Chair,  
Department of Mathematics

---

Dr. Corey Dunn  
Graduate Coordinator,  
Department of Mathematics

## ABSTRACT

In this thesis, we will give our discovery of original symmetric presentations of several important groups. We have investigated permutation and monomial progenitors  $2^{*8} : (2^3 : 2^2)$ ,  $2^{*9} : (3^2 : 2^4)$ ,  $2^{*10} : (2^4 : (2 \times 5))$ ,  $5^{*4} :_m (2^3 : 2^2)$ ,  $7^{*8} :_m (3^2 : 2^4)$ , and  $3^{*5} :_m (2^4 : (2 \times 5))$ . The finite images of the above progenitors include the Mathieu sporadic group  $M_{12}$ , the linear groups  $L_2(8)$  and  $L_2(13)$ , and the extensions  $S_6 \times 2$ ,  $2^8 : .L_2(8)$ , and  $2^7 : .A_5$ . We will show our construction of the four groups  $S_3$ ,  $L_2(8)$ ,  $L_2(13)$ , and  $S_6 \times 2$  over  $S_3$ ,  $2^2$ ,  $S_3 : 2$ , and  $S_5$ , by using the technique of double coset enumeration. We will also provide isomorphism types all of the groups that have appeared as finite homomorphic images. We will show that the group  $L_2(8)$  does not satisfy the conditions of Iwasawa's Lemma and that the group  $L_2(13)$  is simple by Iwasawa's Lemma. We give constructions of  $M_{22} \times 2$  and  $M_{22}$  as homomorphic images of the progenitor  $S_6$ .

## ACKNOWLEDGEMENTS

It is hard to transfer all my feelings into several lines. In simple words, I want to thank Allah for giving me this chance to improve my life and to help me through it. I want to extend sincere thanks to my greatest adviser I have ever met, Dr. Zahid Hasan. Dr. Zahid started with me from the zero in the Group Theory. He guided me through developing my thesis. I could not have done my thesis without Dr. Zahed's advises. I would like also to thank some of the faculty members of the mathematics department who support me with the M.A. program as the Chair and Graduate Coordinator, Dr. Charles Stanton and Dr. Corey Dunn. Respectively, they collaborated and advised me in the program. I will not forget my committee members of my thesis Dr. Joseph Chavez and Dr. Ilseop Han with their assistance. Moreover, I appreciate my government for the financial support and the health care. I thank my family for standing by my side in all the difficulties that I have faced. I thank my mother, Kefaiah Mansour, and my father, Abdulkarim Marouf, for pushing me to success from I was born to the last day in my life. From my heart, I thank my grandma, Aisha, for her prayers to my succeed in future. I thank my sisters and my brothers for encouraging me to be where I am at right now. Last but not least, I thank my friends who pray for me, or be next to me when I need a company.

# Table of Contents

<b>Abstract</b>	<b>iii</b>
<b>Acknowledgements</b>	<b>iv</b>
<b>List of Tables</b>	<b>viii</b>
<b>List of Figures</b>	<b>ix</b>
<b>1 Basic in Groups</b>	<b>1</b>
1.1 Permutation of Groups . . . . .	1
1.2 Groups . . . . .	1
1.3 Subgroup . . . . .	4
1.4 Cyclic Groups . . . . .	4
1.5 Group Homomorphisms . . . . .	4
1.6 Coset . . . . .	5
<b>2 Extensions of Groups and Relations</b>	<b>6</b>
2.1 Extensions of Groups . . . . .	6
2.2 Relations . . . . .	7
<b>3 Wreath Product of Permutation Groups</b>	<b>10</b>
3.1 $2^{*5} : \mathbb{Z}_2 \wr \mathbb{Z}_3$ . . . . .	10
<b>4 The Transitive Group</b>	<b>15</b>
4.1 The Transitive Group (8,22) . . . . .	15
4.2 Isomorphic Type of $N$ . . . . .	18
4.3 The Transitive Group (9,19) . . . . .	21
4.4 The Transitive Group (18,12) . . . . .	21
<b>5 Progenitors</b>	<b>23</b>
5.1 Progenitors $2^{*30} : S_6$ of $M_{22}$ . . . . .	23
5.2 Progenitors $2^{*60} : 2 \times A_5$ of $J_1$ . . . . .	23
5.3 Progenitors $2^{*13} : (13 : 4)$ of $SZ_8$ . . . . .	24

5.4	Progenitors $2^{*78} : (13 : 12)$ of $twf_{42}$ , The Lie Group Twisted $F(4, 2)$ on 1755 Letters . . . . .	24
5.5	Progenitors $2^{*17} : (17 : 2)$ . . . . .	25
5.6	Progenitors $2^{*49} : N$ . . . . .	25
5.7	Progenitors $2^{*12} : N$ . . . . .	25
5.8	Progenitors $2^{*48} : N$ . . . . .	26
5.9	Progenitors $2^{*24} : N$ . . . . .	26
<b>6</b>	<b>Double Coset Enumeration</b>	<b>28</b>
6.1	The Double Coset Enumeration of $2^{*3} : S_3$ Over $S_3$ . . . . .	28
6.2	The Isomorphism Type of $N$ . . . . .	32
6.3	The Double Coset Enumeration of $3^{*3} : S_3$ Over $S_5$ . . . . .	35
6.4	Construction Of $L_2(8)$ . . . . .	42
<b>7</b>	<b>Simple Groups</b>	<b>68</b>
7.1	The Group $L_2(8)$ Over $2^2$ . . . . .	68
7.2	Construction Of The Simple Group $L_2(13)$ . . . . .	74
7.3	Construction of $S_6$ . . . . .	99
7.4	How To Write The Elements of The Group: . . . . .	108
<b>8</b>	<b>Construction of <math>M_{22}</math></b>	<b>110</b>
8.1	Double Coset Enumeration of $M_{22} \times 2$ Over $S_6$ . . . . .	110
8.2	Factor $M_{22} \times 2$ By It's Center . . . . .	126
<b>9</b>	<b>Group Representation and Character Theory</b>	<b>134</b>
9.1	Group Representation . . . . .	134
9.2	Character Theory . . . . .	136
9.3	Character Table . . . . .	138
9.4	Induced Character and Monomial Character . . . . .	143
9.5	The Monomial Progenitor $5^{*4} :_m (2^3 : 2^2)$ . . . . .	143
9.6	The Monomial Progenitor $7^{*8} :_m (3^2 : 2^4)$ . . . . .	150
<b>10</b>	<b>Homomorphic Images</b>	<b>156</b>
10.1	The Group $M_{22}$ . . . . .	156
10.2	The Group $M_{24}$ . . . . .	157
10.3	The Group $M_{11}$ . . . . .	158
10.4	The Group $M_{12}$ . . . . .	159
10.5	The Group $J_1$ . . . . .	160
10.6	The Group $J_2$ . . . . .	160
<b>Appendix A</b>	<b>MAGMA Code for DCE of <math>L_2(8)</math> Over <math>2^2</math></b>	<b>165</b>
<b>Appendix B</b>	<b>MAGMA Code for DCE of <math>L_2(13)</math> Over <math>M</math> and <math>N</math></b>	<b>185</b>
<b>Appendix C</b>	<b>MAGMA Code for DCE of <math>S_6 \times 2</math> Over <math>S_5</math></b>	<b>205</b>

<b>Appendix D</b>	<b>MAGMA Code for DCE of <math>M_{22} \times 2</math> Over <math>S_6</math></b>	<b>210</b>
<b>Appendix E</b>	<b>MAGMA Code for DCE of <math>M_{22}</math> Over <math>S_6</math></b>	<b>220</b>
<b>Appendix F</b>	<b>MAGMA Code for The Progenitor <math>2^{*8} : (2^3 : 2^2)</math></b>	<b>224</b>
<b>Appendix G</b>	<b>MAGMA Code for The Progenitor <math>2^{*9} : (3^2 : 2^4)</math></b>	<b>229</b>
<b>Appendix H</b>	<b>MAGMA Code for The Progenitor <math>2^{*10} : (2^4 : (2 \times 5))</math></b>	<b>233</b>
<b>Appendix I</b>	<b>MAGMA Code for The Progenitor <math>2^{*18} : (2.(3^2 : 2))</math></b>	<b>235</b>
<b>Appendix J</b>	<b>MAGMA Code for Monomial Progenitor <math>5^{*4} :_m (2^3 : 2^2)</math></b>	<b>240</b>
<b>Appendix K</b>	<b>MAGMA Code for Monomial Progenitor <math>7^{*8} :_m (3^2 : 2^4)</math></b>	<b>250</b>
<b>Appendix L</b>	<b>MAGMA Code for Monomial Progenitor <math>3^{*5} :_m (2^4 : (2 \times 5))</math></b>	<b>258</b>
<b>Appendix M</b>	<b>MAGMA Code for Isomorphism Type of <math>2^8 : \bullet L_2(8)</math></b>	<b>264</b>
<b>Appendix N</b>	<b>MAGMA Code for Isomorphism Type of <math>2^7 : \bullet A_5</math></b>	<b>270</b>
<b>Appendix O</b>	<b>MAGMA Code for Isomorphism Type of <math>3 : (PSL(2, 19) \times 2)</math></b>	<b>276</b>
<b>Appendix P</b>	<b>MAGMA Code for Isomorphism Type of <math>2^3 : \bullet (L_3(4) \times 2)</math></b>	<b>279</b>
<b>Appendix Q</b>	<b>MAGMA Code for Isomorphism Type of <math>2^2 : M_{12}</math></b>	<b>284</b>
<b>Appendix R</b>	<b>MAGMA Code for Isomorphism Type of <math>2^6 : \bullet S_4</math></b>	<b>287</b>
<b>Appendix S</b>	<b>MAGMA Code for Isomorphism Type of <math>2 : S_7</math></b>	<b>292</b>
<b>Bibliography</b>		<b>295</b>



# List of Tables

3.1	$\gamma(3)$ . . . . .	11
3.2	$\gamma(4)$ . . . . .	11
3.3	$\gamma(5)$ . . . . .	12
3.4	$\gamma \cdot k^*$ . . . . .	12
4.1	Some Finite Homomorphic Image of $2^{*8} : N$ . . . . .	18
4.2	Some Finite Homomorphic Image of $2^{*9} : N$ . . . . .	21
4.3	Some Finite Homomorphic Images of $2^{*18} : N$ . . . . .	22
7.1	Permutation Representation of $x, y,$ and $t_0$ . . . . .	103
9.1	Table for Conjugacy Classes of $S_3$ . . . . .	137
9.2	Character Table of $S_3$ . . . . .	139
9.3	Table of Conjugacy Classes of $D_9$ . . . . .	140
10.1	Some Finite Homomorphic Image of $2^{*16} : (2^4 : 2)$ . . . . .	157
10.2	Some Finite Homomorphism Image of $2^{*6} : ((2 \times 3) : 2)$ . . . . .	158
10.3	Some Finite Homomorphism Image of $2^{*8} : (2^3 : 2)$ . . . . .	159
10.4	Some Finite Homomorphism Image of $2^{*8} : (2^3 : 2)$ . . . . .	160
10.5	Some Finite Homomorphism Image of $2^{*6} : ((2 \times 3) : 2)$ . . . . .	162
10.6	Some Finite Homomorphism Image of $2^{*12} : ((2^2 \times 3) : 2)$ . . . . .	164

# List of Figures

6.1	Cayley Diagram for $2^3 : S_3$ Over $S_3$ . . . . .	32
6.2	Cayley Diagram for $S_5$ Over $S_3$ . . . . .	41
6.3	Cayley Diagram for $L_2(8)$ Over $2^2$ . . . . .	67
7.1	Cayley Diagram for $L_2(13)$ Over $M$ and $N$ . . . . .	94
7.2	Cayley Diagram for $S_6 \times 2$ Over $S_5$ . . . . .	102
7.3	Cayley Diagram for $S_6$ Over $S_5$ . . . . .	107
8.1	Cayley Diagram for $M_{22} \times 2$ Over $S_6$ . . . . .	125
8.2	Cayley Diagram for $M_{22}$ Over $S_6$ . . . . .	133

# Chapter 1

## Basic in Groups

In this chapter we will define the group and the permutation. Then we will introduce some different groups with some examples about them. For example, we will talk about the symmetric group, alternating group, dihedral group, and the general linear group. On the other hand, we will give some properties and relation about groups.

### 1.1 Permutation of Groups

**Definition 1.1.** If  $X$  is a nonempty set, a **permutation** of  $X$  is a bijection  $\alpha : X \rightarrow X$ . We denote the set of all permutation of  $X$  by  $S_X$ .

**Lemma 1.2.** Let  $S$  be a set.

1. Let  $f$  and  $g$  be two permutations of  $S$ . Then the composition of  $f$  and  $g$  is a permutation of  $S$ .
2. Let  $f$  be a permutation of  $S$ . Then the inverse of  $f$  is a permutation of  $S$ .

**Definition 1.3.** A permutation  $\alpha \in S$  is **even** if it is a product of an even number of transpositions; otherwise,  $\alpha$  is **odd**.

### 1.2 Groups

**Definition 1.4.** A group is a set  $G$  together with a binary operation  $(a, b) \mapsto a * b : G \times G \rightarrow G$  satisfying the following conditions:

1. (Associativity) for all  $a, b, c \in G$ ,  $(a * b) * c = a * (b * c)$ .
2. (Existence of a neutral element) there exists an element  $e \in G$  such that  $a * e = a = e * a$ , for all  $a \in G$ .
3. (Existence of inverses) for each  $a \in G$ , there exists an  $a^{-1} \in G$  such that  $a * a^{-1} = e = a^{-1} * a$ .

We usually abbreviate  $(G, *)$  to  $G$ . Also, we usually write  $ab$  for  $a * b$ ,  $1$  or  $Id$  for  $e$ , and  $a^{-1}$  for  $a^{-1}$ . There is no requirement that  $a * b = b * a$  for all  $a, b \in G$ . If this property (commutative) does hold, we say that  $G$  is abelian.

**Definition 1.5. Symmetric Group:**

The set  $S_X$  of bijections  $\varphi : X \rightarrow X$  from  $X$  to itself forms a group under composition whose identity element is the identity function  $\varphi(x) = x$ , called the **symmetric group** of  $X = 1, 2, \dots, n$ . The elements of  $S_X$  are usually called permutations, and the identity is the trivial permutation.

Since  $X$  is set with  $1, 2, \dots, n$  elements imply  $S_X$ , we define  $S_X$  by  $S_n$  which called the symmetric group with  $n$  letters. We can find the order of  $S_n$  by having the factorial of  $n$ . Otherwise,  $S_n$  is non-abelian group because  $\varphi(xy) \neq \varphi(yx)$  for all  $x, y \in X$ .

**Example 1.6.** Suppose we have the group  $S_3$  as symmetric group send  $X = 1, 2, 3$  to itself. Find all the element to  $S_3$  and its order?

We have  $S_3$  is a group of 6 elements, and the elements of  $S_3$  will be  $e$ ,  $a = (1, 2, 3)$ ,  $a^2 = (1, 3, 2)$ ,  $b = (2, 3)$ ,  $ab = (1, 2)$ , and  $a^2b = (1, 3)$ .

**Definition 1.7. Alternating Group:**

The alternating group is that group which have even permutations of  $n$  degree; for all  $n > 1$ , we denote that by  $A_n$ . We can generate that by saying  $A_n$  is the subgroup of  $S_n$  in order of that the order of  $A_n$  is  $\frac{n!}{2}$ , so it will be all the even permutation in  $S_n$ .

**Example 1.8.** Find the order and all the elements of the group  $A_3$ .

We can see that the order of  $A_3$  is 3, so the group  $A_3$  has 3 elements the two 3-cycles and the identity which are  $e$ ,  $a = (1, 2, 3)$ , and  $a^2 = (1, 3, 2)$ . As what we say before it is clearly that  $A_3$  is subgroup of  $S_3$ , and we defined that by  $A_3 \triangleleft S_3$ .

**Definition 1.9. Dihedral Group:**

The **dihedral group**  $D_n$  or  $D_{2n}$ , for  $(2n \geq 4)$  is the group of order  $2n$  which is generated by two elements  $s$  and  $t$  such that

$$s^n = 1, t^2 = 1, \text{ and } tst = s^{-1}.$$

Note that  $D_{2n}$  is not abelian for all  $n \geq 3$ , while  $D_4$  is the 4-group  $V$ .

Otherwise,  $D_n$  can be defined to be the subgroup of  $S_n$  generated by  $r : i \rightarrow i + 1 \pmod{n}$  and  $s : i \rightarrow n + 2 - i \pmod{n}$ .

For example, the order of the dihedral group  $D_3$  is 6, and the elements of the group are to be  $e, a = (1, 2), b = (2, 3), ab = (1, 3, 2), ba = (1, 2, 3), aba = (13)$ . By comparing between the results of example 1.1 and this example, we can see clearly that  $S_3$  and  $D_3$  have the same elements and the same orders. So, we can say that  $D_3$  is symmetric subgroup of  $S_3$ .

**Definition 1.10. General Linear Group:**

Let  $F$  be a field. The  $n \times n$  matrices with coefficients in  $F$  and nonzero determinant form a group  $GL_n(F)$  called the general linear group of degree  $n$ . For a finite dimensional  $F$ -vector space  $V$ , the  $F$ -linear automorphisms of  $V$  form a group  $GL(V)$  called the general linear group of  $V$ . Note that if  $V$  has dimension  $n$ , then the choice of a basis determines an isomorphism  $GL(V) \rightarrow GL_n(F)$  sending an automorphism to its matrix with respect to the basis.

**Definition 1.11.** The number of elements of a group (finite or infinite) is called its **order**. We will use  $|G|$  to denote the order of  $G$ .

**Definition 1.12.** The **order of an element**  $g$  in a group  $G$  is the smallest positive integer  $n$  such that  $g^n = e$ . (In additive notation, this would be  $ng = 0$ ). If no such integer exists, we say that  $g$  has infinite order. The order of an element  $g$  is denoted by  $|g|$ .

**Definition 1.13.** Let  $a$  be a fixed element of a group  $G$ . The **centralizer** of  $a$  in  $G$ ,  $C_G(a)$ , is the set of all elements in  $G$  that commute with  $a$ . In symbols,  $C_G(a) = \{g \in G | ga = ag\}$ .

### 1.3 Subgroup

**Definition 1.14.** A nonempty subset  $S$  of a group  $G$  is a **subgroup** of  $G$  if  $s \in G$  implies  $s^{-1} \in G$  and  $s, t \in G$  imply  $st \in G$ .

**Definition 1.15.** A subgroup  $K \leq G$  is a **normal subgroup**, denoted by  $K \triangleleft G$ , if  $gKg^{-1} = K$  for every  $g \in G$ .

**Definition 1.16.** If  $x \in G$ , then a **conjugate** of  $x$  in  $G$  is an element of the form  $axa^{-1}$  for some  $a \in G$ ; equivalently,  $x$  and  $y$  are conjugate if  $y = \gamma_a(x)$  for some  $a \in G$ .

### 1.4 Cyclic Groups

**Definition 1.17.** A group  $G$  is called **cyclic** if there is an element  $a$  in  $G$  such that  $G = \{a^n | n \in \mathbb{Z}\}$ . Such an element  $a$  is called a **generator** of  $G$ . We may indicate that  $G$  is a **cyclic group** generated by  $a$  by writing  $G = \langle a \rangle$ .

**Theorem 1.18. Theorem (Cayley, 1878):**

Every group  $G$  can be imbedded as a subgroup of  $S_G$ . In particular, if  $|G| = n$ , then  $G$  can be imbedded in  $S_n$ .

### 1.5 Group Homomorphisms

**Definition 1.19.** Let  $(G, *)$  and  $(H, \circ)$  be groups. A function  $f : G \rightarrow H$  is a **homomorphism** if, for all  $a, b \in G$ ,  $f(a * b) = f(a) \circ f(b)$ . An **isomorphism** is a homomorphism that is also a bijection. We say that  $G$  is **isomorphic** to  $H$ , denoted by  $G \cong H$ , if there exists an isomorphism  $f : G \rightarrow H$ . An isomorphism  $f : G \rightarrow G$  is called **automorphism**.

**Definition 1.20.** An **automorphism** of a group  $G$  is an isomorphism  $\varphi : G \rightarrow G$ . A subgroup  $H$  of  $G$  is called **characteristic** in  $G$ , denoted by  $H \text{ char } G$ , if  $\varphi(H) = H$  for every automorphism  $\varphi$  of  $G$ .

**Definition 1.21.** Let  $f : G \rightarrow H$  be a homomorphism, and define **kernel**  $f = \{a \in G : f(a) = 1\}$ , and **image**  $f = \{h \in H : h = f(a) \text{ for some } a \in G\}$ .

**Theorem 1.22. (First Isomorphism Theorem (Jordan, 1870))** Let  $\phi$  be a group homomorphism from  $G$  to  $\bar{G}$ . Then the mapping from  $G/\text{Ker}\phi$  to  $\phi(G)$ , given by  $g\text{Ker}\phi \rightarrow \phi(g)$ , is an isomorphism. In symbols,  $G/\text{Ker}\phi \cong \phi(G)$ .

## 1.6 Coset

**Definition 1.23.** Let  $G$  be a group and let  $H$  be a subset of  $G$ . For any  $a \in G$ , the set  $\{ah|h \in H\}$  is denoted by  $aH$ . Analogously,  $Ha = \{ha|h \in H\}$  and  $aHa^{-1} = aha^{-1}|h \in H$ . When  $H$  is a subgroup of  $G$ , the set  $aH$  is called the **left coset** of  $H$  in  $G$  containing  $a$ , where as  $Ha$  is called the **right coset** of  $H$  in  $G$  containing  $a$ . In this case, the element  $a$  is called the coset representative of  $aH$  (or  $Ha$ ). We use  $|aH|$  to denote the number of elements in the set  $aH$ , and  $|Ha|$  to denote the number of elements in  $Ha$ .

If  $S \leq G$ , then the **index** of  $S$  in  $G$ , denoted by  $[G : S]$ , is the number of right cosets of  $S$  in  $G$ .

**Theorem 1.24.** (Lagrange) If  $G$  is a finite group and  $S \leq G$ , then  $|S|$  divides  $|G|$  and  $[G : S] = |G|/|S|$ .

**Definition 1.25.** If  $X$  is a set and  $G$  is a group, then  $X$  is the  **$G$ -set** if there is a function  $\alpha : G \times X \rightarrow X$  (called an **action**), denoted by  $\alpha : (g, x) \rightarrow gx$ , such that :

1.  $1x = x$  for all  $x \in X$ ; and
2.  $g(hx) = (gh)x$  for all  $g, h \in G$  and  $x \in X$ .

One also say that  $G$  **act** on  $X$ . If  $|X| = n$ , then  $n$  is called the **degree** of the  $G$ -set  $X$ .

## Chapter 2

# Extensions of Groups and Relations

In this chapter we will offer to the reader the definitions of extensions of groups with given some examples. Then we will show other type of product which is the wreath product. Finally, we will give some ways to find relations such as the first order relation and the Lemma.

### 2.1 Extensions of Groups

#### The Direct Product

**Definition 2.1.** If  $H$  and  $K$  are groups, then their **direct product**, denoted by  $H \times K$ , is group with elements all ordered pairs  $(h, k)$ , where  $h \in H$  and  $k \in K$ , and with operation  $(h, k)(h', k') = (hh', kk')$ .

It is easy to check that  $H \times K$  is group: the identity is  $(1, 1)$ ; the inverse  $(h, k)^{-1}$  is  $(h^{-1}, k^{-1})$ . Notice that neither  $H$  nor  $K$  is a subgroup of  $H \times K$ , but  $H \times K$  does contain isomorphic replicas of each, namely,  $H \times 1 = \{(h, 1) : h \in H\}$  and  $1 \times K = \{(1, k) : k \in K\}$ .

**Theorem 2.2.** Let  $G$  be a group with normal subgroups  $H$  and  $K$ . If  $HK = G$  and  $H \cap K = 1$ , then  $G \cong H \times K$ .

**Corollary 2.3.** If  $G = H \times K$ , then  $G/(H \times 1) \cong K$ .



## Semi-direct Product

**Definition 2.4.** A group  $G$  is a **semi-direct product** of  $K$  by  $Q$ , denoted by  $G = K : Q$ , if  $K \triangleleft G$  and  $K$  has a complement  $Q_1 \cong Q$ . One also says that  $G$  **splits** over  $K$ . However,  $Q_1$  is a normal subgroup, then  $G$  is the direct product  $K \times Q_1$ .

A **progenitor** is a semi-direct product of the following form:

$$P \cong 2^{*n} : N = \{ \pi\omega \mid \pi \in N, \omega \text{ a reduced word in the } t_i \}.$$

Where  $2^{*n}$  denotes a free product of  $n$  copies of the cyclic group of order 2 generated by involutions  $t_i$  for  $i = 1, \dots, n$ ; and  $N$  is a transitive permutation group of degree  $n$  which acts on the free product by permuting the involutory generators.

## Central Extension

**Definition 2.5.** A **central extension** of  $K$  by  $Q$  is an extension  $G$  of  $K$  by  $Q$  with  $K \leq Z(G)$ .

## 2.2 Relations

A progenitor  $P \cong m^{*n} : N$  is infinite. In order to find finite homomorphism images. We factor it by appropriate relations. In this part we will introduce two possible ways to get relations which can help the reader to find the homomorphism images for any progenitors.

### The First Order Relation

In order to find the first order relations, we need to find a presentation of the progenitor  $G = m^{*n} : N$ . Now we find the first order relation. Then, we will factor the progenitor by finding the classes of  $N$ . We compute the centralizers of all classes non-identity and the orbits of all the centralizers, then we will create that first order relation from those orbits. We will give some examples from groups which we will talk about it in more details in chapter 4. However we use MAGMA to give all those steps.

**Example 2.6.** *The Progenitor  $2^{*8} : (2 \bullet 2^4)$*

*In order to state the steps of the first order relations we use a presentation of the progenitor  $G = 2^{*8} : (2 \bullet 2^4)$ . We will talk about this later in chapter 4.*

```

S:=Sym(8);
aa:=S! (2, 5)(6, 7);
bb:=S! (1, 2)(3, 7)(4, 5)(6, 8);
cc:=S! (1, 3)(2, 6)(4, 8)(5, 7);
dd:=S! (1, 2)(3, 6)(4, 5)(7, 8);
ee:=S! (1, 4)(2, 5)(3, 8)(6, 7);
N:=sub<S/aa,bb,cc,dd,ee>;
G<a,b,c,d,e,t>:=Group<a,b,c,d,e,t/a^2,b^2,c^2,d^2,
e^2,b^a=b*e,c^a=c,c^b=c*e,d^a=d*e,d^b=d,d^c=d,e^a=e
,e^b=e,e^c=e,e^d=e,t^2,(t,a),(t,b*d)>;
C:=Classes(N);
C;
Conjugacy Classes of group N
-----
[1]      Order 1      Length 1
      Rep Id(N)

[2]      Order 2      Length 1
      Rep (1, 4)(2, 5)(3, 8)(6, 7)

[3]      Order 2      Length 2
      Rep (1, 2)(3, 7)(4, 5)(6, 8)
:
:
[17]     Order 4      Length 2
      Rep (1, 6, 4, 7)(2, 8, 5, 3)

C2:=Centraliser(N,N!(1, 4)(2, 5)(3, 8)(6, 7));
C3:=Centraliser(N,N!(1, 2)(3, 7)(4, 5)(6, 8));
:
:
C17:=Centraliser(N,N!(1, 6, 4, 7)(2, 8, 5, 3));
Set(C2); Orbits(C2);
Set(C3); Orbits(C3);
:
:
Set(C17); Orbits(C17);

```

Since we let  $t$  to be  $t_1$ . Then, we find the following from the orbits.

```

Orbits(C2)= GSet{@ 1, 2, 3, 4, 5, 6, 7, 8 @}
The relation has to be (e*t)^f
Orbits(C3)= GSet{@ 1, 2, 5, 3, 4, 7, 6, 8 @}
The relation has to be (b*t)^j

```

```

:
:
Orbits(C17)= GSet{@ 1, 6, 2, 4, 8, 5, 7, 3 @}
The relation has to be (a*c*d*t)^r

```

After we find the first order relations, we will add them to the presentation of the progenitor and run it in MAGMA to find some homomorphic images. We also write relations based on the following lemma.

**Lemma 2.7.** (Curtis(page58))  $N \cap \langle t_i, t_j \rangle \leq C_N(N_{ij})$ , where  $N_{ij}$  denotes the stabilizer in  $N$  of the two points  $i$  and  $j$ .

In this case we will factor the progenitor  $G = m^{*n} : N$  by finding the point stabilizer of  $i$  and  $j$ ,  $N_{ij}$ , in  $N$ . In order to create relations we will let  $t$  be  $t_i$ . According to the above lemma, the stabilizer is if  $x \in N_{ij}$  such that it sends  $i \rightarrow j$  and  $j \rightarrow i$  then we have  $(x * t_i)^m = 1$ , where  $m$  is a positive integer. Also, if  $y \in N_{ij}$  fixes  $i$  or  $j$  the relation  $(t_i * t_j)^k = y$ . We add then we try these relations in the presentation of the progenitor to get the homomorphic images.

**Example 2.8. The Progenitor  $2^{*8} : (2 \bullet 2^4)$**

In this example we let  $t$  be  $t_1$  and we will find the stabilizer  $N^{12}$ .

```

> N12:=Stabiliser(N,{1,2});
> N12;
Permutation group N12 acting on a set of cardinality 8
Order = 4 = 2^2
(3, 8)(6, 7)
(1, 2)(3, 7)(4, 5)(6, 8)

```

We know that the element  $(3, 8)(6, 7)$  is  $b * d$ , and the element  $(1, 2)(3, 7)(4, 5)(6, 8)$  is  $b$ , so the relations have to be  $(t * t^b)^k = b * d$  and  $(b * t)^m = 1$  respectively.

## Chapter 3

# Wreath Product of Permutation Groups

**Definition 3.1.** Let  $H$  and  $K$  be permutation groups on  $X$  and  $Y$ , respectively. Let  $Z = X \times Y$ , define the permutation groups on  $Z$ . Called the wreath product of  $H$  by  $K$ , given by  $H \wr K$  or  $H \wr K$ .

Let  $\gamma \in H$  and  $y$  be the fixed element of  $Y$ . Define by,

$$\gamma(y) = \begin{cases} (x, y) \mapsto ((x)\gamma, y) \\ (x, y_1) \mapsto (x, y_1), \text{ if } y_1 \neq y \end{cases}$$

Let  $k \in K$ , define by  $k^*(x, y) \mapsto (x, (y)k)$ .

### 3.1 $2^{*5} : \mathbb{Z}_2 \wr \mathbb{Z}_3$

We consider the Permutation Wreath Product  $2^{*5} : \mathbb{Z}_2 \wr \mathbb{Z}_3$ .

The order of this group is  $2^3 \cdot 3 = 24$ .

Suppose,  $X = \{1, 2\}$ ,

$Y = \{3, 4, 5\}$ ,

$H = \mathbb{Z}_2 = \{e, (12)\}$ ,

$K = \mathbb{Z}_3 = \{e, (345)\}$ ,

$\gamma = (12)$ ,

The  $Z = X \times Y = \{(1, 3), (1, 4), (1, 5), (2, 3), (2, 4), (2, 5)\}$ .

We label the elements of  $Z$  as follow:

$$1) \rightarrow (1,3)$$

$$2) \rightarrow (1,4)$$

$$3) \rightarrow (1,5)$$

$$4) \rightarrow (2,3)$$

$$5) \rightarrow (2,4)$$

$$6) \rightarrow (2,5)$$

We will use the function  $\gamma(y)$  to compute the images of elements of  $Y$ , we will try all of them.

Starting with  $\gamma(3)$  we found that, We see from the above table that 1 goes to 4 and 4

Table 3.1:  $\gamma(3)$

The Permutation	$\gamma(3)$	The Label
$(1,3) \rightarrow$	$(2,3)$	$1 \rightarrow 4$
$(1,4) \rightarrow$	$(1,4)$	$2 \rightarrow 2$
$(1,5) \rightarrow$	$(1,5)$	$3 \rightarrow 3$
$(2,3) \rightarrow$	$(1,3)$	$4 \rightarrow 1$
$(2,4) \rightarrow$	$(2,4)$	$5 \rightarrow 5$
$(2,5) \rightarrow$	$(2,5)$	$6 \rightarrow 6$

goes to 1, so the permutation is  $H(3) = (1, 4)$ .

Then the Second element  $\gamma(4)$  we found that, We see from the above table that 1 goes

Table 3.2:  $\gamma(4)$

The Permutation	$\gamma(4)$	The Label
$(1,3) \rightarrow$	$(1,3)$	$1 \rightarrow 1$
$(1,4) \rightarrow$	$(2,4)$	$2 \rightarrow 5$
$(1,5) \rightarrow$	$(1,5)$	$3 \rightarrow 3$
$(2,3) \rightarrow$	$(2,3)$	$4 \rightarrow 4$
$(2,4) \rightarrow$	$(1,4)$	$5 \rightarrow 2$
$(2,5) \rightarrow$	$(2,5)$	$6 \rightarrow 6$

to 5 and 5 goes to 1, so the permutation is  $H(4) = (2, 5)$ .

$\gamma(5)$  is found in table below.

We see from the above table that 3 goes to 6 and 6 goes to 3, so the permutation is  $H(5) = (3, 6)$ .

$H(3) \times H(4) \times H(5) = (1, 4) \times (2, 5) \times (3, 6)$ . New, given  $k = (345)$ , and the formula for

Table 3.3:  $\gamma(5)$ 

The Permutation	$\gamma(5)$	The Label
(1,3) $\rightarrow$	(1,3)	1 $\rightarrow$ 1
(1,4) $\rightarrow$	(1,4)	2 $\rightarrow$ 2
(1,5) $\rightarrow$	(2,5)	3 $\rightarrow$ 6
(2,3) $\rightarrow$	(2,3)	4 $\rightarrow$ 4
(2,4) $\rightarrow$	(2,4)	5 $\rightarrow$ 5
(2,5) $\rightarrow$	(1,5)	6 $\rightarrow$ 3

$\gamma \cdot k^*$  is  $(x, y) \mapsto (x, yk)$ .

Table 3.4:  $\gamma \cdot k^*$ 

The Permutation	$k = (345)$	The Label
(1,3) $\rightarrow$	(1,4)	1 $\rightarrow$ 2
(1,4) $\rightarrow$	(1,5)	2 $\rightarrow$ 3
(1,5) $\rightarrow$	(1,3)	3 $\rightarrow$ 1
(2,3) $\rightarrow$	(2,4)	4 $\rightarrow$ 5
(2,4) $\rightarrow$	(2,5)	5 $\rightarrow$ 6
(2,5) $\rightarrow$	(2,3)	6 $\rightarrow$ 4

We see from the above table that the permutation is  $k^* = (1, 2, 3)(4, 5, 6)$ .

We now use MAGMA to check the answer,

```

> S:=Sym(6);
> X:=S!(1,4);
> Y:=S!(2,5);
> Z:=S!(3,6);
> F:=S!(1,2,3)(4,5,6);
> N:=sub<S|X,Y,Z,F>;
> #N;
24
> W:=WreathProduct(CyclicGroup(2),CyclicGroup(3));
> #W;
24
> S:=IsIsomorphic(N,W);
> S;
true
> N1:=Stabiliser(N,1);
> N1;
Permutation group N1 acting on a set of cardinality 6
Order = 4 = 2^2

```

```

(2, 5)
(3, 6)
Permutation group N12 acting on a set of cardinality 6
Order = 2
(3, 6)
> C:=Centraliser(N,N12);
> C;
Permutation group C acting on a set of cardinality 6
Order = 8 = 2^3
(2, 5)
(1, 4)
(3, 6)
> N14:=Stabiliser(N,[1,4]);
> N14;
Permutation group N14 acting on a set of cardinality 6
Order = 4 = 2^2
(2, 5)
(3, 6)
> C:=Centraliser(N,N14);
> C;
Permutation group C acting on a set of cardinality 6
Order = 8 = 2^3
(1, 4)
(3, 6)
(2, 5)
> NN:=G;
> Sch:=SchreierSystem(NN,sub<NN|Id(NN)>);
> ArrayP:=Id(N): i in [1..24];
> for i in [2..24] do
for> P:=Id(N): l in [1..#Sch[i]];
for> for j in [1..#Sch[i]] do
for|for> if Eltseq(Sch[i])[j] eq 1 then P[j]:=X; end if;
for|for> if Eltseq(Sch[i])[j] eq 2 then P[j]:=Y; end if;
for|for> if Eltseq(Sch[i])[j] eq 3 then P[j]:=Z; end if;
for|for> if Eltseq(Sch[i])[j] eq 4 then P[j]:=F; end if;
for|for> if Eltseq(Sch[i])[j] eq -4 then P[j]:=F^-1; end if;
for|for> end for;
for> PP:=Id(N);
for> for k in [1..#P] do
for|for> PP:=PP*P[k]; end for;
for> ArrayP[i]:=PP;
for> end for;
>for i in [1..24] do if ArrayP[i] eq N!(2, 5) then print Sch[i];
end if; end for;

```

```

y
> for i in [1..24] do if ArrayP[i] eq N!(3,6) then print Sch[i];
  end if; end for;
z
H<X,Y,Z,F,t>:=Group<X,Y,Z,F,t|X^2,Y^2,Z^2,F^3,(X,Y),(X,Z),(Y,Z),
X^F=Y,Y^F=Z,Z^F=X,t^2,(t,X),(t,Y),(t,Z)>; #H;
> for k,l,m,n,o in [0..24] do
for> H<X,Y,Z,F,t>:=Group<X,Y,Z,F,t|X^2,Y^2,Z^2,F^3,(X,Y),(X,Z),
(Y,Z),X^F=Y,Y^F=Z,Z^F=X,t^2,(t,Y),(t,Z),(t*t^F)^k=Z,(t*t^X)^l=Z>;
#H; k,l,m,n,o; end for;

```



## Chapter 4

# The Transitive Group

We will work in this chapter on some  $k$ -transitive Groups and learn how to find them by using MAGMA. First of all, in order to find the permutation for a transitive group on  $k$  points, we use MAGMA to determine how many transitive group on  $k$  points exist. We can chose any transitive groups and find faithful permutation representations. Second, we will use MAGMA to find the progenitor  $(2^{*k} : N)$ . In this project we will chose  $k$  to be 8, 9, and 18 respectively. Third, we will find the homomorphic images for  $G$ . Finally, we will show the isomorphic type of the subgroup  $N$  of  $S_k$ . Here, we are starting with some definitions of transitive group.

**Definition 4.1.** *A  $G$ -set  $X$  is **transitive** if it has one orbit; that is, for every  $x, y \in X$ , there exists  $\sigma \in G$  with  $y = \sigma x$ .*

### 4.1 The Transitive Group (8,22)

By using MAGMA we will find a faithful permutation representation of the transitive group (8,22)..

```
> NumberOfTransitiveGroups(8);
50
> N:=TransitiveGroup(8,22);
> D:=SmallGroupDatabase ();
> G:=SmallGroup(D,IdentifyGroup(N)[1],IdentifyGroup(N)[2]);
> f,G1,k:=CosetAction(G,sub<G|Id(G)>);
> SL:=Subgroups(G1);
```

```

> T:= {X'subgroup: X in SL};
> TrivCore:={H:H in T| #Core(G1,H) eq 1};
> mdeg:=Min({Index(G1,H):H in TrivCore});
> Good:={H: H in TrivCore| Index(G1,H) eq mdeg};
> H:=Rep(Good);
> f,G1,K := CosetAction(G1,H);
> G1;
Permutation group G1 acting on a set of cardinality 8
Order = 32 = 2^5
(2, 5)(6, 7)
(1, 2)(3, 7)(4, 5)(6, 8)
(1, 3)(2, 6)(4, 8)(5, 7)
(1, 2)(3, 6)(4, 5)(7, 8)
(1, 4)(2, 5)(3, 8)(6, 7)
> FPGGroup(G);
Finitely presented group on 5 generators
Relations
$.1^2 = Id($)
$.2^2 = Id($)
$.3^2 = Id($)
$.4^2 = Id($)
$.5^2 = Id($)
$.2^$.1 = $.2 * $.5
$.3^$.1 = $.3
$.3^$.2 = $.3 * $.5
$.4^$.1 = $.4 * $.5
$.4^$.2 = $.4
$.4^$.3 = $.4
$.5^$.1 = $.5
$.5^$.2 = $.5
$.5^$.3 = $.5
$.5^$.4 = $.5$
Mapping from: GrpFP to GrpPC: G
> G<a,b,c,d,e>:=Group<a,b,c,d,e|a^2,b^2,c^2,d^2,e^2,b^a=b*e,
c^a=c,c^b=c*e,d^a=d*e,d^b=d,d^c=d,e^a=e,e^b=e,e^c=e,e^d=e>;
> #G;
32

```

By using the Schreier System and the point stabilizer in MAGMA we will write a presentation for the progenitor  $2^{*8} : N$ .

```

Sch:=SchreierSystem(G,sub<G|Id(G)>);
ArrayP:=[Id(N): i in [1..32]];

```

```

for i in [2..32] do
P:=Id(N): 1 in [1..#Sch[i]];
for j in [1..#Sch[i]] do
if Eltseq(Sch[i])[j] eq 1 then P[j]:=aa; end if;
if Eltseq(Sch[i])[j] eq 2 then P[j]:=bb; end if;
if Eltseq(Sch[i])[j] eq 3 then P[j]:=cc; end if;
if Eltseq(Sch[i])[j] eq 4 then P[j]:=dd; end if;
if Eltseq(Sch[i])[j] eq 5 then P[j]:=ee; end if;
end for;
PP:=Id(N);
for k in [1..#P] do
PP:=PP*P[k]; end for;
ArrayP[i]:=PP;
end for;
for i in [1..32] do Sch[i], ArrayP[i]; end for;
N1:=Stabiliser(N,1);
N1;
Permutation group N1 acting on a set of cardinality 8
Order = 4 = 2^2
      (2, 5)(6, 7)
      (3, 8)(6, 7)

> G<a,b,c,d,e,t>:=Group<a,b,c,d,e,t|a^2,b^2,c^2,d^2,e^2,b^a=b*e,c^a=c,
c^b=c*e,d^a=d*e,d^b=d,d^c=d,e^a=e,e^b=e,e^c=e,e^d=e,t^2,(t,a),(t,b*d)>;
> #G;

```

We add the first order relation as we showed in chapter 2, and have this presentation;

```

for f,j,h,i,l,S,n,o,p,q,x,y,z,v,s,g,I,u,r in [0..10] do
G<a,b,c,d,e,t>:=Group<a,b,c,d,e,t|a^2,b^2,c^2,d^2,e^2,b^a=b*e,c^a=c,
c^b=c*e,d^a=d*e,d^b=d,d^c=d,e^a=e,e^b=e,e^c=e,e^d=e,t^2,(t,a),(t,b*d)
,(e*t)^f,(b*t)^j,(c*t)^h,(a*t)^i,(a*t^b)^l,(a*c*t)^S,(a*b*c*t)^n,
(b*d*t)^o,(b*d*t^b)^p,(d*t)^q,(c*d*t)^x,(a*b*d*t)^y,(a*b*d*t^b)^z
,(a*b*e*t)^v,(b*c*t)^s,(b*c*d*t)^g,(a*d*e*t)^I,(a*b*c*d*t)^u,
(a*c*d*t)^r>;
if #G gt 32 then f,j,h,i,l,S,n,o,p,q,x,y,z,v,s,g,I,u,r,
Index(G,sub<G|a,b,c,d,e>), #G; end if; end for;

```

By using the lemma, we get this presentation;

```

for r,k in [0..10] do
G<a,b,c,d,e,t>:=Group<a,b,c,d,e,t|a^2,b^2,c^2,d^2,e^2,b^a=b*e
,c^a=c,c^b=c*e,d^a=d*e,d^b=d,d^c=d,e^a=e,e^b=e,e^c=e,e^d=e,t^2
,(t,a),(t,b*d),(a*c*d*t)^r,(t*t^b)^k=b*d>;

```

Table 4.1: Some Finite Homomorphic Image of  $2^{*8} : N$ 

$a$	...	$v$	$s$	$g$	$I$	$u$	$r$	Order of $G$	Group Name
0	...	0	0	0	0	3	5	15360	$2^7 : \bullet(A_5 \times 2)$
0	...	0	0	0	3	5	10	7680	$2^7 : \bullet A_5$
0	...	0	0	0	3	7	9	129024	$2^8 : \bullet L_2(8)$
0	...	0	0	0	3	8	7	86016	$2^8 : \bullet(2^4 \times 3 \times 7)$
0	...	0	0	0	4	5	6	61440	$2^3 : \bullet(2^9 \times 3 \times 5)$
0	...	0	0	0	5	5	4	20480	$2^7 : \bullet(2^5 \times 5)$
0	...	0	9	9	10	3	9	20520	$3 : (PSL(2, 19) \times 2)$

```
r,k,#G; end for;
:
2 9 288
2 10 320
3 2 768
```

## 4.2 Isomorphic Type of $N$

Consider the subgroup  $N$  of  $S_8$  below. We will show that  $N$  is isomorphic to the semi-direct product of  $(4 \times 2)$  by  $2^2$ . We will search for the largest Abelian subgroup,  $NL[i]$ , of  $N$ , using the normal subgroup lattice  $NL$ .

```
> for i in [1..68] do if IsAbelian(NL[i]) then i; end if; end for;
1
.
.
49
50
```

Thus,  $NL[50]$  is the largest Abelian subgroup of  $N$ . We factor  $N$  by  $NL[50]$ , and call it  $q$ . Thus  $N$  is a mixed extension of  $NL[50]$  by  $q$ , the factor group  $N/NL[50]$ . We now find isomorphism type and presentations of  $NL[50]$  and  $q$ . We show below that  $NL[50]$  is isomorphic to  $4 \times 2$ .

```
> X:=AbelianGroup(GrpPerm,[4,2]);
> IsIsomorphic(NL[50],X);
true Mapping from: GrpPerm: $, Degree 8, Order 2^3 to GrpPerm: X
Composition of Mapping from: GrpPerm: $, Degree 8, Order 2^3 to GrpPC and
Mapping from: GrpPC to GrpPC and
Mapping from: GrpPC to GrpPerm: X
```

$NL[50]$  is generated by  $A$  and  $B$  given below.

```
> A:=N!(1, 8, 4, 3)(2, 6, 5, 7);
> B:=N!(1, 6)(2, 3)(4, 7)(5, 8);
> A*B eq B*A;
true
> A*B;
(1, 5, 4, 2)(3, 6, 8, 7)
> NL[50] eq sub<N|A,B>;
true
```

A presentation of  $NL[50]$  is  $\{x, y | x^4, y^2, (x, y)\}$ . We factor  $N$  by  $N[50]$  and find the generators of  $q$  a presentation for  $q$ .

```
> q,ff:=quo<N|NL[50]>;
> q1:=q.1; q3:=q.3;
> q eq sub<q|q.1,q.3>;
> true
```

We show below that  $q$  is isomorphic to  $2^2$ .

```
> H<a,b>:=Group<a,b|a^2,b^2,(a*b)^2>;
> #H;
4
> f,h1,k:=CosetAction(H,sub<H|Id(H)>);
> s:=IsIsomorphic(h1,q);
true Isomorphism of GrpPerm: h1, Degree 4, Order 2^2 into GrpPerm: q,
> Degree 4, Order 2^2 induced by
> (1, 2)(3, 4) |--> (1, 2)(3, 4)
> (1, 3)(2, 4) |--> (1, 3)(2, 4)
```

We now see if the generators and relations of  $q$  can be expressed in terms of non-identity elements of  $NL[50]$ .

```
> T:=Transversal(N,NL[50]);
> q,ff:=quo<N|NL[50]>;
> ff(T[2]) eq q.1;
true
> ff(T[3]) eq q.3;
true
> ff(T[2]*T[3]) eq q.1*q.3;;
true
> Order(T[2]) eq Order(q.1);
true
```

```

> Order(T[3]) eq Order(q.3);
true
> Order(T[2]*T[3]) eq Order(q.1*q.3);
true
> /* true Order(T[2]) eq Order(q1); true
> Order(T[3]) eq Order(q3); true
> Order(T[2]*T[3]) eq Order(q.1*q.3); true */

```

The computation above demonstrates, it is not possible. Thus  $N$  is a semi-direct product of  $NL[50]$  by  $q$ ; that is,  $4 \times 2$  by  $2^2$ . Thus  $N$  is isomorphic to  $(4 \times 2) : 2^2$ . We now determine the action of  $q$  on  $NL[50]$ .

```

> A^T[2];
(1, 8, 4, 3)(2, 6, 5, 7)
> A^T[3];
(1, 3, 4, 8)(2, 7, 5, 6)
> B^T[2];
(1, 7)(2, 8)(3, 5)(4, 6)
> B^T[3];
(1, 6)(2, 3)(4, 7)(5, 8)
> A,A^2,A^3,B,A*B,A^2*B,A^3*B;
(1, 8, 4, 3)(2, 6, 5, 7)
(1, 4)(2, 5)(3, 8)(6, 7)
(1, 3, 4, 8)(2, 7, 5, 6)
(1, 6)(2, 3)(4, 7)(5, 8)
(1, 5, 4, 2)(3, 6, 8, 7)
(1, 7)(2, 8)(3, 5)(4, 6)
(1, 2, 4, 5)(3, 7, 8, 6)

```

Here is a presentation for the semi-direct product of  $4 \times 2$  by  $2^2$ .

```

> G<x,y,a,b>:=Group<x,y,a,b|x^4,y^2,(x,y),a^2,b^2,(a*b)^2=x^2,x^a=x,
x^b=x^3,y^a=x^2*y,y^b=y>;
> #G;
32

```

Now, we show that  $G$  is isomorphic to the semi-direct product of  $4 \times 2$  by  $2^2$ .

```

> f1,g1,k1:=CosetAction(G,sub<G|Id(G)>);
> IsIsomorphic(g1,N);
true Mapping from: GrpPerm: g1 to GrpPerm: N
Composition of Mapping from: GrpPerm: g1 to GrpPC and
Mapping from: GrpPC to GrpPC and
Mapping from: GrpPC to GrpPerm: N

```

Thus,  $N$  is isomorphic  $(2^3 : 2^2)$ .

### 4.3 The Transitive Group (9,19)

By using Magma we will find a faithful permutation representation of the transitive group (9,19)..

```
S:=Sym(9);
aa:=S!(2, 3, 4, 8, 5, 7, 9, 6);
bb:=S!(2, 4)(3, 7)(5, 9);
cc:=S!(2, 4, 5, 9)(3, 8, 7, 6);
dd:=S!(2, 5)(3, 7)(4, 9)(6, 8);
ee:=S!(1, 2, 5)(3, 6, 9)(4, 8, 7);
ff:=S!(1, 3, 7)(2, 6, 4)(5, 9, 8);
N:=sub<S|aa,bb,cc,dd,ee,ff>;
```

After we work in MAGMA, we find that the transitive group (9,19) is semi-direct product of  $3^2$  by  $2^4$ , and we write it as  $N = 3^2 : 2^4$ . Subsequently, by adding relations to the presentation of  $2^{*9} : N$ , we get the following homomorphic images.

```
for E,w,F,q,j,n,o,r,u,i,y,h,l,s,x,z in [0..10] do
G<a,b,c,d,e,f,t>:=Group<a,b,c,d,e,f,t|a^8,b^2,c^4,d^2,e^3,f^3\
,(e,f),a^2=c,c^2=d,b^a=b*c*d,c^a=c,c^b=c*d,d^a=d,d^b=d,d^c=d,\
e^a=f,e^b=e*(f^2),e^c=e*(f^2),e^d=e^2,f^a=e*(f^2),f^b=f^2,f^c\
=(e^2)*(f^2),f^d=f^2,f^e=f,t^2,(t,a),(t,b),(t,c),(t,d),(c*f^-1\
1*c*t)^E,(c*f^-1*c*t^(f*c))^w,(b*f*t)^F,(b*f*t^e)^q,(e*t)^j,(\
e*c^-1*t)^n,(e*c^-1*t^(f*c))^o,(a*e*b*t)^r,(a*e*b*t^(f^-1))^u\
,(a*e*b*t^e)^i,(e*b*t)^y,(e*b*t^e)^h,(a*t)^l,(a*t^e)^s,(a*d*t)\
^x,(a*d*t^e)^z>;
if #G gt 144 then E,w,F,q,j,n,o,r,u,i,y,h,l,s,x,z, Index(G,sub\
<G|a,b,c,d,e,f>), #G; end if; end for;
```

Table 4.2: Some Finite Homomorphic Image of  $2^{*9} : N$

$E$	...	$y$	$h$	$l$	$s$	$x$	$z$	Order of $G$	Group Name
0	...	0	0	0	0	0	6	645120	$2^3 : \bullet(L_3(4) \times 2)$
0	...	0	4	0	0	0	0	73728	$2^9 : (2^4 \times 3^2)$
0	...	0	5	0	0	0	8	518400	$(A_6 \times A_6) : (2^2)$
0	...	0	6	0	0	0	8	5668704	$3^7 : (2^5 \times 3^4)$
0	...	5	0	0	0	0	0	1555200	$3 : (S_6 \bullet S_6)$
0	...	6	6	0	0	0	8	629856	$3^5 : (2^5 \times 3^4)$

### 4.4 The Transitive Group (18,12)

By using MAGMA we will find a permutation of the transitive group (18,12)..

```

S:=Sym(18);
aa:=S! (3, 7)(4, 9)(5, 10)(6, 12)(8, 14)(11, 17)(13, 15)(16, 18);
bb:=S! (1, 2)(3, 5)(4, 6)(7, 10)(8, 11)(9, 12)(13, 16)(14, 17)(15, 18);
cc:=S! (1, 3, 7)(2, 5, 10)(4, 8, 13)(6, 11, 16)(9, 15, 14)(12, 18, 17);
dd:=S! (1, 4, 9)(2, 6, 12)(3, 8, 15)(5, 11, 18)(7, 13, 14)(10, 16, 17);
N:=sub<S|aa,bb,cc,dd>;

```

After we work in MAGMA, we find that the transitive group (18,12) is a central extension of 2 by  $[3^2 : 2]$ , and we can define it as  $N = 2.[3^2 : 2]$ . Subsequently, by adding relations to the presentation of  $2^{*18} : N$ , we get the following homomorphic images.

```

for e,f,g,h,i,j,l,n,o,p,q,r,s,w,x,y,z,v,u in [0..10] do
G<a,b,c,d,t>:=Group<a,b,c,d,t|a^2,b^2,c^3,d^3,b^a=b,c^a=c^2,c^b=c,
d^a=d^2,d^b=d,d^c=d,t^2,(t,a),(b*t)^e,(a*t)^f,(a*t^c)^g,(a*t^d)^h,
(a*t^(c*d))^i,(a*t^(d*c^-1))^j,(a*b*t)^l,(a*b*t^c)^n,(a*b*t^d)^o,
(a*b*t^(c*d))^p,(a*b*t^(d*c^-1))^q,(c*t)^r,(d*t)^s,(c*d*t)^w,
((c*d^-1)*t)^x,(b*c*t)^y,(b*d*t)^z,(b*c*d*t)^v,((b*c*d^-1)*t)^u>;
if #G gt 36 then e,f,g,h,i,j,l,n,o,p,q,r,s,w,x,y,z,v,u,
Index(G,sub<G|a,b,c,d>), #G; end if; end for;

```

Table 4.3: Some Finite Homomorphic Images of  $2^{*18} : N$

$e$	...	$w$	$x$	$y$	$z$	$v$	$u$	Order of $G$	Group Name
0	...	0	0	3	3	9	9	78732	$3^7 : (2^2 \times 3^2)$
0	...	0	3	0	8	4	0	63763200	63763200
0	...	0	3	4	8	10	0	1062720	$(2 \bullet GL(2, 81))$
0	...	0	3	5	0	5	6	188743680	188743680
0	...	0	3	5	5	8	0	368640	$2^{10} : \bullet A_6$
0	...	0	3	6	6	7	3	1524096	$(PSL(2, 8) \times PSL(2, 8)) : S_3$
0	...	0	4	0	0	3	4	2211840	$2^9 : (S_3 \bullet A_6)$



## Chapter 5

# Progenitors

In this chapter we will discuss some important groups and presentations.

### 5.1 Progenitors $2^{*30} : S_6$ of $M_{22}$

```
S:=Sym(30);
xx:=S!(1, 2, 4, 8)(3, 6, 11, 18, 26, 20, 29, 22)(5, 10, 17, 12, 19,
      28, 30, 25)(7,13, 21, 27, 15, 24, 23, 14)(9, 16);
yy:=S!(1, 3, 7, 14, 23, 29, 4, 9)(2, 5, 10, 6, 12, 20, 28, 30)(8,
      15, 25, 21)(11,16, 26, 19, 13, 22, 24, 17)(18, 27);
N:=sub<S|xx,yy>;
G<x,y,t>:=Group<x,y,t|x^8,y^8,(x*y^-2*x)^2,(x^-1*y^-1)^4,(x*y^-1)^4,
      (y^-1*x^-1*y*x^3*y*x^-1*y^-1*x),(y*x*y*x^3*y*x*y^2),t^2,(t,x^4),
      (t,x*y*x^-1*y^-2*x),(t,x*y*x*y*x^-1*y^-1)>;
```

### 5.2 Progenitors $2^{*60} : 2 \times A_5$ of $J_1$

```
S:=Sym(60);
xx:=S!(1, 2)(3, 9)(4, 7)(5, 12)(6, 13)(8, 16)(10, 20)(11, 18)
      (14, 26)(15, 24)(17,29)(19, 32)(21, 35)(23, 33)(25, 37)
      (27, 40)(28, 41)(30, 44)(31, 42)(36,46)(38, 47)(39, 48)
      (43, 52)(45, 54)(49, 53)(50, 56)(51, 57)(55, 59);
yy:=S!(1, 3, 10, 4, 11, 5)(2, 6, 14, 7, 15, 8)(9, 17, 30, 18,
      31, 19)(12, 21, 34,20, 33, 22)(13, 23, 36, 24, 35, 25)
      (16, 27, 39, 26, 38, 28)(29, 41, 51,42, 48, 43)(32, 45,
      37, 44, 53, 46)(40, 49, 55, 47, 54, 50)(52, 58, 56,57,
      60, 59);
zz:=S!(1, 4)(2, 7)(3, 11)(5, 10)(6, 15)(8, 14)(9, 18)(12, 20)
      (13, 24)(16, 26)(17,31)(19, 30)(21, 33)(22, 34)(23, 35)
```

```

(25, 36)(27, 38)(28, 39)(29, 42)(32,44)(37, 46)(40, 47)
(41, 48)(43, 51)(45, 53)(49, 54)(50, 55)(52, 57)(56,59)
(58, 60);
N:=sub<S|xx,yy,zz>;
G<x,y,z,t>:=Group<x,y,z,t|x^2,y^6,z^2,(y^3*z),(x*z)^2,(x*y^-1)^5
,t^2,(t,y^-1*x*y^-1*x*y*x*y),(t,t^x),(t,t^y),(t,t^z),(t,t^(y^5))
,(t,t^(x*y)),(t,t^(y*z)),(t,t^(x*y^5)),(t,t^(y^2)),(t,t^(y*z)),
(t,t^((y^5)*x)),(t,t^(x*y*x)),(t,t^(x*y^2)),(t,t^(x*y*z)),(t,t^
(x*(y^5)*x)),(t,t^(y*x*y)),(t,t^(y*x*y^5)),(t,t^((y^2)*x)),(t,t^
((y^5)*x*y)),(t,t^((y^5)*x*(y^5))),(t,t^(x*(y^4)*x)),(t,t^(x*(y^
2)*x)),(t,t^(x*(y^5)*x*y)),(t,t^(x*(y^5)*x*(y^5))),(t,t^(y*x*(y^
2))),(t,t^(y*x*(y^4))),(t,t^((y^2)*x*y)),(t,t^(x*y*x*(y^2)*z*x))
,(t,t^(x*(y^5)*x*(y^2))),(t,t^(x*(y^5)*x*y*x)),(t,t^(y*x*y*x*(y^
5))),(t,t^(x*(y^5)*x*y*x*z))>;

```

### 5.3 Progenitors $2^{*13} : (13 : 4)$ of $SZ_8$

```

S:=Sym(13);
xx:=S!(1, 2, 3, 5)(4, 8, 7, 10)(6, 9, 11, 13);
yy:=S!(1, 4, 9, 8, 10, 13, 7, 3, 2, 6, 12, 11, 5);
N:=sub<S|xx,yy>;
G<x,y,t>:=Group<x,y,t|x^4,(x^-1*y^-1*x^2*y^-1*x^-1),(x*y^-2*x^-1*y^3),
t^2,(t,(x^-1)*y)>;

```

### 5.4 Progenitors $2^{*78} : (13 : 12)$ of $twf_{42}$ ,

#### The Lie Group Twisted $F(4, 2)$ on 1755 Letters

```

S:=Sym(78);
xx:=S!(1, 2, 5)(3, 9, 11)(4, 12, 15)(6, 17, 13)(7, 18, 20)(8, 21, 19)
(10, 24, 26)(14, 32, 34)(16, 37, 22)(23, 39, 42)(25, 48, 50)
(27, 52, 54)(28, 55, 53)(29, 30, 56)(31, 58, 59)(33, 44, 61)
(35, 63, 46)(36, 65, 64)(38, 67, 47)(40, 68, 69)(41, 70, 66)
(43, 57, 51)(45, 71, 60)(49, 72, 73)(62, 77, 75)(74, 78, 76);
yy:=S!(1, 3)(4, 13)(5, 14)(7, 19)(8, 22)(9, 23)(10, 20)(11, 25)(12, 24)
(15, 33)(16, 28)(17, 38)(21, 44)(26, 49)(27, 53)(30, 57)(31, 56)
(32, 58)(34, 60)(35, 64)(36, 39)(37, 62)(40, 66)(41, 51)(42, 69)
(43, 46)(45, 63)(47, 54)(48, 70)(50, 59)(52, 72)(55, 73)(61, 76)
(65, 71)(67, 78)(74, 77);
zz:=S!(1, 4, 14, 33, 60, 76, 65, 67, 39, 17, 9, 6)(2, 7, 3, 10, 25, 49
, 59, 55, 32, 16, 5, 8)(11, 27, 23, 47, 69, 78, 68, 77, 66, 37
, 48, 28)(12, 29, 13, 31, 38, 50, 54, 70, 72, 51, 26, 30)(15,
35, 24, 43, 20, 41, 18, 40, 19, 42, 44, 36)(21, 45, 22, 34, 62

```

```
, 58, 75, 56, 74, 57, 61, 46)(52, 63, 53, 64, 73, 71);
N:=sub<S|xx,yy,zz>;
G<x,y,z,t>:=Group<x,y,z,t|x^3,y^2,(z*y*x*z),(z*x*y*x^-1*z^-1*y),t^2,
(t,x*y*x^-1)>;
```

## 5.5 Progenitors $2^{*17} : (17 : 2)$

```
S:=Sym(17);
xx:=S!(1, 2)(3, 6)(4, 5)(7, 10)(8, 9)(11, 14)(12, 13)(15, 16);
yy:=S!(1, 3, 7, 11, 15, 17, 16, 14, 10, 6, 2, 5, 9, 13, 12, 8, 4);
N:=sub<S|xx,yy>;
G<x,y,t>:=Group<x,y,t|x^2,y^-17,(y^-1*x)^2,t^2,(t,x*y^7)>;
```

## 5.6 Progenitors $2^{*49} : N$

```
S:=Sym(49);
xx:=S!(1, 3, 8, 12, 28, 4, 11)(2, 6, 16, 17, 20, 10, 25)(5, 14,
31, 35, 41, 24,40)(7, 19, 39, 30, 42, 15, 33)(9, 22, 43,
44, 48, 23, 36)(13, 29, 47,45, 49, 26, 46)(18, 37, 34, 38
, 27, 32, 21);
yy:=S!(1, 2, 5, 13, 15, 32, 48)(3, 6, 14, 29, 33, 21, 23)(4, 10,
24, 26, 30, 38, 43)(7, 18, 36, 8, 16, 31, 47)(9, 12, 17,
35, 45, 19, 37)(11, 25, 40, 46, 42, 27, 44)(20, 41, 49,
39, 34, 22, 28);
zz:=S!(2, 4, 9, 21, 42, 49, 31)(3, 7, 17, 34, 24, 44, 13)(5,
12, 27, 47, 10, 23, 39)(6, 15, 11, 26, 22, 35, 18)(8,
20, 40, 29, 19, 38, 48)(14, 30, 36, 25, 45, 32, 28);
N:=sub<S|xx,yy,zz>;
G<x,y,z,t>:=Group<x,y,z,t|x^7,y^7,z^7,(x,y),(z*x^-2*z^-1*y^-1),
(y^-2*x^-2*z*y*z^-1),t^2,(t,z)>;
```

## 5.7 Progenitors $2^{*12} : N$

```
S:=Sym(12);
xx:=S!(1, 4)(2, 3)(5, 6)(7, 10)(8, 9)(11, 12);
yy:=S!(1, 3, 5, 4, 2, 6)(7, 9, 11, 10, 8, 12);
zz:=S!(1, 7, 4, 10)(2, 8, 3, 9)(5, 11, 6, 12);
ww:=S!(1, 2, 5)(3, 6, 4)(7, 11, 8)(9, 10, 12);
N:=sub<S|xx,yy,zz,ww>;
G<x,y,z,w,t>:=Group<x,y,z,w,t|x^2,z^4,w^3,(y^3*x),(z^-1*x*z^-1),
(y,z),(y,w),(z^-1*w^-1*z*w^-1),t^2,(t,x*y*w^-1)>;
```

## 5.8 Progenitors $2^{*48} : N$

```

S:=Sym(48);
aa:=S!(1, 9)(2, 10)(3, 11)(4, 12)(5, 21)(6, 22)(7, 23)(8, 24)
      (13, 33)(14, 34)(15, 35)(16, 36)(17, 41)(18, 42)(19, 43)
      (20, 44)(25, 32)(26, 31)(27, 30)(28,29)(37, 45)(38, 46)
      (39, 47)(40, 48);
bb:=S!(1, 5, 20, 4, 8, 17)(2, 6, 19, 3, 7, 18)(9, 29, 40, 12,
      32, 37)(10, 30, 39, 11, 31, 38)(13, 26, 44, 16, 27, 41)
      (14, 25, 43, 15, 28, 42)(21, 46, 34, 24, 47, 35)(22, 45,
      33, 23, 48, 36);
cc:=S!(1, 13)(2, 14)(3, 15)(4, 16)(5, 22)(6, 21)(7, 24)(8, 23)
      (9, 33)(10, 34)(11, 35)(12, 36)(17, 40)(18, 39)(19, 38)
      (20, 37)(25, 31)(26, 32)(27, 29)(28, 30)(41, 48)(42, 47)
      (43, 46)(44, 45);
dd:=S!(1, 2)(3, 4)(5, 6)(7, 8)(9, 10)(11, 12)(13, 14)(15, 16)
      (17, 18)(19, 20)(21, 22)(23, 24)(25, 26)(27, 28)(29, 30)
      (31, 32)(33, 34)(35, 36)(37, 38)(39, 40)(41, 42)(43, 44)
      (45, 46)(47, 48);
ee:=S!(1, 2)(3, 4)(5, 22)(6, 21)(7, 24)(8, 23)(9, 10)(11, 12)
      (13, 14)(15, 16)(17, 45)(18, 46)(19, 47)(20, 48)(25, 31)
      (26, 32)(27, 29)(28, 30)(33, 34)(35, 36)(37, 41)(38, 42)
      (39, 43)(40, 44);
gg:=S!(1, 3)(2, 4)(5, 7)(6, 8)(9, 11)(10, 12)(13, 15)(14, 16)
      (17, 19)(18, 20)(21, 23)(22, 24)(25, 27)(26, 28)(29, 31)
      (30, 32)(33, 35)(34, 36)(37, 39)(38, 40)(41, 43)(42, 44)
      (45, 47)(46, 48);
hh:=S!(1, 11)(2, 12)(3, 9)(4, 10)(5, 25)(6, 26)(7, 27)(8, 28)
      (13, 35)(14, 36)(15, 33)(16, 34)(17, 47)(18, 48)(19, 45)
      (20, 46)(21, 32)(22, 31)(23, 30)(24,29)(37, 43)(38, 44)
      (39, 41)(40, 42);
N:=sub<S|aa,bb,cc,dd,ee,gg,hh>;
G<x,y,z,w,u,v,k,t>:=Group<x,y,z,w,u,v,k,t|x^2,y^6,z^2,w^2,u^2,
v^2,k^2,(x*z)^2,(y^-1*w*y*w),(x*w)^2,(z*w)^2,(x*u)^2,(z*u)^2,
(w*u)^2,(y^-1*v*y*v),(x*v)^2,(z*v)^2,(w*v)^2,(u*v)^2,(x*k)^2,
(z*k)^2,(w*k)^2,(u*k)^2,(v*k)^2,(y^-3*w*v),(z*x*y^-1*u*y),
(k*z*y^-1*k*y),(k*w*y^-1*z*y),(u*x*y^-2*u*k*y^-1),t^2,(t,w*u),
(t,x*v*k)>;

```

## 5.9 Progenitors $2^{*24} : N$

```

S:=Sym(24);
xx:=S!(1, 2)(3, 4)(5, 6)(7, 8)(9, 13)(10, 14)(11, 16)(12, 15)

```

```

(17, 22)(18, 21)(19,23)(20, 24);
yy:=S!(1, 6)(2, 5)(3, 7)(4, 8)(9, 10)(11, 12)(13, 14)(15, 16)
(17, 21)(18, 22)(19, 24)(20, 23);
zz:=S!(1, 9, 18, 2, 10, 17)(3, 11, 20, 4, 12, 19)(5, 13, 22,
6, 14, 21)(7, 15, 24, 8, 16, 23);
ww:=S!(1, 8, 2, 7)(3, 6, 4, 5)(9, 16, 10, 15)(11, 14, 12, 13)
(17, 24, 18, 23)(19, 22, 20, 21);
uu:=S!(1, 2)(3, 4)(5, 6)(7, 8)(9, 10)(11, 12)(13, 14)(15, 16)
(17, 18)(19, 20)(21,22)(23, 24);
vv:=S!(1, 5, 2, 6)(3, 7, 4, 8)(9, 21, 10, 22)(11, 23, 12, 24)
(13, 18, 14, 17)(15, 20, 16, 19);
N:=sub<S|xx,yy,zz,ww,uu,vv>;
G<x,y,z,w,u,v>:=Group<x,y,z,w,u,v|x^2,y^2,z^6,w^4,u^2,v^4,(x*y)^2,
(y*z^-1*x*z),(z^3*u),(x*w^-1*x*w),(y*w^-1*y*w),(z,w),(w^-2*u),
(v^-1*w^2*v^-1),(x*v^-1*x*v),(z^-1*v^-1*z^-1*v),(w,v),
(z^-1*y*x*z*x)>;

```

## Chapter 6

# Double Coset Enumeration

**Definition 6.1.** Let  $H$  and  $K$  be subgroups of a group  $G$ . A **double coset** of  $H$  and  $K$  in  $G$  is a set of the form  $HaK = \{hak \mid h \in H, k \in K\}$  for some  $a \in G$ .

**Theorem 6.2.** (*Coset Enumeration*)

Let  $G$  have a presentation with a finite number of generators and relations. Set up one table for each relation, add new integer entries and enlarge the auxiliary table when possible, and delete any large numbers involved in coset collapse. If the procedure ends with all relation tables complete and having  $n$  rows, then the presented group  $G$  has order  $n$ .

### 6.1 The Double Coset Enumeration of $2^{*3} : S_3$ Over $S_3$

We take the progenitor  $2^{*3} : S_3$ , where  $2^{*3}$  is the free product of 3 copies of the cyclic groups of order 2, and  $S_3$  is the group of automorphisms of  $2^{*3}$  which permutes the three symmetric generators by conjugation and factor it by the relation  $t_0t_1 = t_1t_0$ .

The double coset enumeration partitions the image of the group  $G$  as a union double cosets  $NgN$  where  $g \in 2^{*3} : S_3$ . Thus, we can find the set of elements  $g_1, g_2, \dots$  of  $G$  such that  $G = Ng_1N \cup Ng_2N \cup \dots$ , and for each  $i$ , we have  $g_i = p_iw_i$ , where  $p_i \in N$ , and  $w_i$  is a word in the  $t_i$ s. Hence, the double coset decomposition is given by

$$G = Nw_1N \cup Nw_2N \cup Nw_3N \cup \dots,$$

where  $w_1 = e$  (the identity). We perform a double coset enumeration of the group  $\frac{2^{*3} : S_3}{[tt^x]^2 = 1}$  over  $S_3$ . We will show

$$G = \frac{2^{*3} : S_3}{[tt^x]^2 = 1} \cong 2^3 : S_3.$$

A symmetric presentation of the progenitor  $2^{*3} : S_3$  is given by:

$$2^{*3} : S_3 \cong \langle x, y, t | x^3, y^2, (x * y)^2, t^2, (t, y) \rangle$$

$G$  factored by  $[tt^x]^2$  which simplify to  $t_0t_1 = t_1t_0$ . Show the simplification where  $N \cong S_3 = \langle x, y \rangle$ , where  $x \sim (1, 2, 3)$  and  $y \sim (12)$ , and  $t = t_3 = t_0$ .

**Using computer-based program - MAGMA :**

1. The order of the group,  $|G|$  is equal to 48.
2. There are 4 double coset in this double coset enumeration of  $G$  over  $N$ .

**Relations**

We see that

$$(tt^x)^2 = 1 \Rightarrow t_0t_1t_0t_1 = 1 \Rightarrow t_0t_1 = t_1t_0.$$

Moreover, if we conjugate the previous relation by all elements in  $S_3 = \{e, (1, 2), (0, 1), (0, 2), (0, 1, 2), (0, 1, 2)\}$  we get relations. We have

1.  $(01 = 10)^e \Rightarrow 01 = 10$
2.  $(01 = 10)^{(1,2)} \Rightarrow 02 = 20$
3.  $(01 = 10)^{(0,1)} \Rightarrow 10 = 01$
4.  $(01 = 10)^{(0,2)} \Rightarrow 21 = 12$
5.  $(01 = 10)^{(0,1,2)} \Rightarrow 12 = 21$
6.  $(01 = 10)^{(0,2,1)} \Rightarrow 20 = 02$

$$\Rightarrow 12 \approx 21, 10 \approx 01 \text{ and } 02 \approx 20.$$

**Double Coset [\*]:** We start with the double coset  $NeN$ , where  $e$  is the word of length zero, denoted by  $[*]$ . We have

$$NeN = \{Nen : n \in N\} = \{Ne\} = \{N\}$$

So, the double coset  $NeN$  consists of the single coset  $N$ . Thus,  $\frac{|N|}{|N|} = \frac{6}{6} = 1$ . Note, since  $N$  is transitive on  $\{0, 1, 2\}$ , we take a representative coset  $N$  from  $[*]$  and a representative from  $\{0, 1, 2\}$  and determine the double coset to which  $Nt_i$  belongs, where  $i \in \{0, 1, 2\}$ . We consider  $i = 0$ , so  $Nt_0$  is a representative coset, and hence we will have a new double coset  $Nt_0N$  which can be denoted by  $[0]$ . There will be three possible  $t_i$ s that can advance to the next double coset  $[0]$ .

### Word of Length One $[0]$

We consider the double coset  $NwN$ , where  $w$  is a word of length one.

$Nt_0N = \{Nt_0n | n \in N\}$ , or  $[0]$ .  $Nt_0N = [0] = \{Nt_0n | n \in N\} = \{Nt_0N, Nt_1N, Nt_2N\}$ .

Since, the point stabilizer of 0 in the subgroup  $N$  is the set of permutations in  $N$  that fix 0 and permute the rest of the elements in the set  $\{1, 2\}$ . **Note:**

$$N^{(0)} = \{n \in N | t_0^n = t_0\} \geq \langle (1, 2) \rangle.$$

Since  $|N^{(0)}| = 2$  then the number of single cosets in  $[0]$  is  $\frac{|N|}{|N^{(0)}|} = \frac{6}{2} = 3$ .

Now, the orbits of  $N^0$  on  $\{0, 1, 2\}$  are  $\{0\}$  and  $\{1, 2\}$ . We choose a representative from each orbit,  $\{0\}$  and  $\{1, 2\}$ . If we choose  $t_0$  from the orbit  $\{0\}$  and choose  $t_1$  from the orbit  $\{1, 2\}$ , then we notice the following :

- $Nt_0 \cdot t_0 = Nt_0^2 = N \in [*]$ . This will collapse and hence it will go back to  $[*]$ . This is denoted by number 1 in Cayley diagram (to the left of the circle containing 3).
- $Nt_0 \cdot t_1 = Nt_0t_1 \in [01]$ . This is a new double coset, which will extend the Cayley diagram from  $[0]$  to  $[01]$ . Since there are 2 elements in this orbit, there are 2  $t_i$ s that extend  $[0]$  to  $[01]$ .

### Word of Length Two $[01]$

We are at a new double coset  $[01]$ ,  $Nt_0t_1N = \{N(t_0t_1)n | n \in N\}$ . Now, to determine all the single cosets of this double cosets, we need to determine the point stabilizer  $N^{01}$ , this means finding the set of elements that fix 0 and 1 in  $N$  and permute the rest of the elements in the set  $\{1, 2, 3\}$ . Now, using our relation  $t_0t_1 = t_0t_2$ . We can see that :

$$0 \rightarrow 0 \text{ and } 1 \rightarrow 2.$$

$$\Rightarrow Nt_0t_1^{(1,2)} = Nt_0t_2 = Nt_0t_1 \Rightarrow (1, 2) \in N^{(01)}.$$

$\Rightarrow N^{(01)} \geq \langle (1, 2) \rangle$ . Thus,  $|N^{(01)}| = 2$ . So, the number of single cosets in  $[01]$  is

$$\frac{|N|}{|N^{(01)}|} = \frac{6}{2} = 3. \text{ In order to find these 3 single cosets, we need to determine the}$$

transversals (right coset representatives) of  $N^{(01)}$  in  $N$ . The 3 single distinct cosets of



the double coset  $[01]$  are:  $\{Nt_0t_1, Nt_0t_2, Nt_1t_2\}$ . Now, we need to find the orbits of  $N^{(01)}$  to advance to the next double coset. From the generator of  $N^{(01)} \geq \langle(1, 2)\rangle$ , the orbits of  $N^{(01)}$  on  $\{0, 1, 2\}$  are:  $\{0\}$ , and  $\{1, 2\}$ . Considering a representative from each orbit of  $N^{(01)}$ , we will choose the following representative from each orbit:  $t_0$  from  $\{0, 1\}$  and  $t_2$  from  $\{2\}$ . Multiply each representative with  $Nt_0t_1$ , :

- $Nt_0t_1 \cdot t_0 = Nt_0t_1t_0 = Nt_1t_0t_0 = Nt_1t_0^2 = Nt_1 \in [0]$ . Hence two elements will go back to that double coset because  $\{0, 1\}$  is one orbit.
- $Nt_0t_1 \cdot t_2 \in [012]$ . New double coset, hence one element can advance from  $[01]$  to  $[012]$  because  $\{2\}$  is separate orbit.

### Word of Length Three $[012]$ :

Again we need to find the point stabilizer of 0, 1 and 2 in  $N$ . This is denoted by  $N^{(012)}$ . Therefore, we need to find the permutations in  $N$  that fix 0, 1, and 2. The coset stabilizer of the coset  $Nt_0t_1t_2$ ,  $N^{(012)} \geq N^{(012)}$ . Using relation  $t_0t_1 = t_1t_0$ , if we multiply both sides by  $t_2$ , we get  $t_0t_1t_2 = t_1t_0t_2$

$$1) N(t_0t_1t_2)^{(012)} = Nt_1t_2t_0 = Nt_1t_0t_2 = Nt_0t_1t_2 \Rightarrow (0, 1, 2) \in N^{(012)}$$

$$2) N(t_0t_1t_2)^{(01)} = Nt_1t_0t_2 = Nt_0t_1t_2 \Rightarrow (0, 1) \in N^{(012)}$$

$$\Rightarrow N^{(012)} \geq \langle(0, 1, 2), (0, 1)\rangle \cong S_3. \text{ Hence, } |N^{(012)}| = 3! = 6, \text{ so } \frac{|N|}{|N^{(012)}|} = \frac{6}{6} = 1.$$

Therefore, there are 1 distinct coset representative. The transversal of  $N^{(012)}$  in  $N$  is:  $Nt_0t_1t_2$ , and the orbit of  $N^{(012)}$  in  $\{0, 1, 2\}$  is  $\{0, 1, 2\}$ . We choose a representative from the orbit, and determine the double cosets to which  $Nt_0t_1t_2t_2$  belongs. But  $Nt_0t_1t_2 \in [01]$ .

### Conclusion:

The double coset enumeration gives that

$$|G| \leq (|N| + \frac{|N|}{|N^{(0)}|} + \frac{|N|}{|N^{(01)}|} + \frac{|N|}{|N^{(012)}|}) \times |N| = (1 + 3 + 3 + 1) \times 6 = (8 \times 6) = 48. \text{ A Cayley diagram of } G \text{ over } S_3 \text{ is given below..}$$

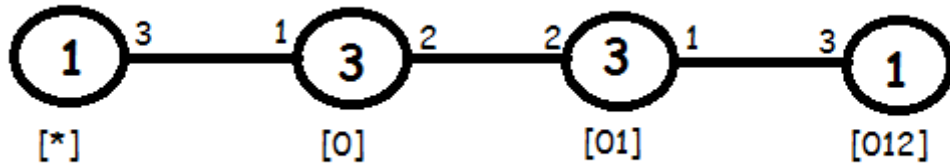
Figure 6.1: Cayley Diagram for  $2^3 : S_3$  Over  $S_3$ 

## 6.2 The Isomorphism Type of $N$

Consider the subgroup  $N$  of  $S_3 = N$  below. We will show that  $N$  is isomorphic to the semi-direct product of 3 by 2. We will search for the largest Abelian subgroup of  $N$ ,  $NL[i]$ , using the normal subgroup lattice  $NL$ .

```
> for i in [1..3] do if IsAbelian(NL[i]) then i; end if; end for;
1
2
```

Thus,  $NL[2]$  is the largest Abelian subgroup of  $N$ . We factor  $N$  by  $NL[2]$ , and call it  $q$ . Then  $N$  is a mixed extension of  $NL[2]$  by  $q$ , the factor group  $N/NL[2]$ . We now find isomorphism types and presentations of  $NL[2]$  and  $q$ .

We show below that  $NL[2]$  is isomorphic to 3.

```
> X:=AbelianGroup(GrpPerm,[3]);
> IsIsomorphic(NL[2],X);
true Isomorphism of GrpPerm: $, Degree 3, Order 3 into GrpPerm: X,
Degree 3, Order 3 induced by
(1, 2, 3) |--> (1, 2, 3) $
```

$NL[2]$  is generated by  $A$  given below.

```
> A:=N!(1, 2, 3);
> NL[2] eq sub<N|A>;
true
```

A presentation of  $NL[2]$  is  $\{x|x^3\}$ . We factor  $N$  by  $N[2]$  and find the generators of  $q$  a presentation for  $q$ .

```
> q,ff:=quo<N|NL[2]>;
> q.2;
```

```
> q eq sub<q|q.2>;
> true
```

We show below that  $q$  is isomorphic to 2.

```
> H<a>:=Group<a|a^2>;
> #H;
2
> f,h1,k:=CosetAction(H,sub<H|Id(H)>);
> s:=IsIsomorphic(h1,q);
> s;
true
```

We now see if the generators and relations of  $q$  can be expressed in terms of nonidentity elements of  $NL[2]$ .

```
> T:=Transversal(N,NL[2]);
> q,ff:=quo<N|NL[2]>;
> ff(T[2]) eq q.2;
true
> Order(T[2]) eq Order(q.2);
true
> /* ff(T[2]) eq q.2; true
true Order(T[2]) eq Order(q.2); true*/
```

The computation above demonstrates, it is not possible. Thus  $N$  is a semi-direct product of  $NL[2]$  by  $q$ ; that is, 3 by 2. Thus  $N$  is isomorphic to 3 : 2. We now determine the action of  $q$  on  $NL[2]$ .

```
> A^T[2];
(1, 3, 2)
> A^-1;
(1, 3, 2)
```

Here is a presentation for the semi-direct product of 3 by 2.

```
> G<x,a>:=Group<x,a|x^3,a^2,x^a=x,x^b=x^3>;
> #G;
6
```

Now, we show that  $N$  is isomorphic to the semi-direct product of 3 by 2 given above.

```
> f1,g1,k1:=CosetAction(G,sub<G|Id(G)>);
> IsIsomorphic(g1,N);
true Mapping from: GrpPerm: g1 to GrpPerm: N
```

Composition of Mapping from: GrpPerm:  $g_1$  to GrpPC and  
Mapping from: GrpPC to GrpPC and  
Mapping from: GrpPC to GrpPerm:  $N$

Thus,  $N$  is isomorphic to  $(3 : 2)$ .

### 6.3 The Double Coset Enumeration of $3^{*3} : S_3$ Over $S_5$

We take the progenitor  $3^{*3} : S_3$ , where  $3^{*3}$  is the free product of three copies of the cyclic groups of order 3, and  $S_3$  is the group of automorphisms of  $3^{*3}$  which permutes the three symmetric generators by conjugation and factor it by the two relations  $t_3t_1 = t_4t_6$  and  $x^2t_1t_5 = t_4t_6$ .

The double coset enumeration partitions the image of the group  $G$  as a union double cosets  $NgN$  where  $g \in 3^{*3} : S_3$ . Thus, we can find the set of elements  $g_1, g_2, \dots$  of  $G$  such that  $G = Ng_1N \cup Ng_2N \cup \dots$ , and for each  $i$ , we have  $g_i = p_iw_i$ , where  $p_i \in N$ , and  $w_i$  is a word in the  $t_i$ s. Hence, the double coset decomposition is given by

$$G = Nw_1N \cup Nw_2N \cup Nw_3N \cup \dots,$$

where  $w_1 = e$  (the identity). We perform a double coset enumeration of the group  $\frac{3^{*3} : S_3}{[tt^x]^2, [xt(t^x)^2]^2}$  over  $S_3$ . We will show

$$G = \frac{3^{*3} : S_3}{[tt^x]^2, [xt(t^x)^2]^2} \cong S_5.$$

A symmetric presentation of the progenitor  $3^{*3} : S_3$  is given by:

$$3^{*3} : S_3 \cong \langle x, y, t|x^3, y^2, (x * y)^2, t^3, (t, y) \rangle$$

$G$  factored by  $(t * t^x)^2$ , and  $(xt(t^x)^2)^2$  which simplify to  $x^2t_1t_5 = t_1t_6$  and  $t_3t_1 = t_4t_6$ .

$$N \cong S_3 = \langle x, y \rangle = \langle (t_1, t_2, t_3)(t_1^2, t_2^2, t_3^2), (t_1, t_2)(t_1^2, t_2^2) \rangle,$$

where  $x \sim (1, 2, 3)(4, 5, 6)$ , and  $y \sim (1, 2)(4, 5)$ , and  $t = t_3$ .

#### Using computer-based program - Magma :

1. The order of the group,  $|G|$  is equal to 120.
2. There are 7 double cosets in this double coset enumeration of  $G$  over  $N$ .

#### Relations

By seeing that (I)  $[xt(t^x)^2]^2 = 1 \Rightarrow [xt_3(t_3^x)^2]^2 = 1 \Rightarrow [xt_3(t_1)^2]^2 = 1 \Rightarrow [xt_3t_4]^2 = 1 \Rightarrow x^2(t_3t_4)^x(t_3t_4) = 1 \Rightarrow x^2t_1t_5t_3t_4 = 1 \Rightarrow x^2t_1t_5 = t_4^{-1}t_3^{-1} \Rightarrow x^2t_1t_5 = t_1t_6 \Rightarrow Nt_1t_5 = t_1t_6$ .

Moreover, if we conjugate the previous relation by all elements in  $S_3 = \{e, (1, 2)(4, 5), (1, 3)(4, 6), (2, 3)(5, 6), (1, 3, 2)(4, 6, 5), (1, 2, 3)(4, 5, 6)\}$  we get relations. We obtain:

1.  $((1, 3, 2)(4, 6, 5)t_1t_5 = t_1t_6)^e \Rightarrow (1, 3, 2)(4, 6, 5)t_1t_5 = t_1t_6$

2.  $((1, 3, 2)(4, 6, 5)t_1t_5 = t_1t_6)^{(1,2)(4,5)} \Rightarrow (2, 3, 1)(5, 6, 4)t_2t_4 = t_2t_6$
3.  $((1, 3, 2)(4, 6, 5)t_1t_5 = t_1t_6)^{(1,3)(4,6)} \Rightarrow (3, 1, 2)(6, 4, 5)t_3t_5 = t_3t_4$
4.  $((1, 3, 2)(4, 6, 5)t_1t_5 = t_1t_6)^{(2,3)(5,6)} \Rightarrow (1, 2, 3)(4, 5, 6)t_1t_6 = t_1t_5$
5.  $((1, 3, 2)(4, 6, 5)t_1t_5 = t_1t_6)^{(1,2,3)(4,6,5)} \Rightarrow (2, 1, 3)(5, 4, 6)t_2t_6 = t_2t_4$
6.  $((1, 3, 2)(4, 6, 5)t_1t_5 = t_1t_6)^{(1,3,2)(4,5,6)} \Rightarrow (3, 2, 1)(6, 5, 4)t_3t_4 = t_3t_5$

$$(II) (tt^x)^2 = 1 \Rightarrow t_3t_1t_3t_1 = 1 \Rightarrow t_3t_1 = t_1^{-1}t_3^{-1} \Rightarrow t_3t_1 = t_4t_6.$$

Moreover, if we conjugate the previous relation by all elements in  $S_3$ , we obtain:

1.  $(31 = 46)^e \Rightarrow 31 = 46$
2.  $(31 = 46)^{(1,2)(4,5)} \Rightarrow 32 = 56$
3.  $(31 = 46)^{(1,3)(4,6)} \Rightarrow 13 = 64$
4.  $(31 = 46)^{(2,3)(5,6)} \Rightarrow 21 = 45$
5.  $(31 = 46)^{(1,2,3)(4,5,6)} \Rightarrow 12 = 54$
6.  $(31 = 46)^{(1,3,2)(4,6,5)} \Rightarrow 23 = 65$

### Double Coset $[*]$ :

We start with the double coset  $NeN$ , where  $e$  is word of length zero, denoted by  $[*]$ . We have

$$NeN = \{Nen : n \in N\} = \{Ne\} = \{N\}$$

So, the double coset  $NeN$  consists of the single coset  $N$ . Thus,  $\frac{|N|}{|N|} = \frac{6}{6} = 1$ .

Note, since  $N$  is transitive on  $\{1, 2, 3, 4, 5, 6\}$ , we take a representative coset  $N$  from  $[*]$  and a representative from  $\{1, 2, 3, 4, 5, 6\}$  and determine the double coset to which  $Nt_i$  belongs, where  $i \in \{1, 2, 3\}$  and  $\{4, 5, 6\}$ . We consider  $i = 3$  and  $i = 6$ , so  $Nt_3$  and  $Nt_6$  are the representative coset, and hence we will have a new double coset  $Nt_3N$  and  $Nt_6N$  which can denoted by  $[3]$  and  $[6]$ . There will be six possibles  $t_i$ s in  $[*]$  that can advance to the next double cosets  $[3]$  and  $[6]$ .

### Word of Length One $[3]$ and $[6]$ :

(i) Word of Length One [3]:

we consider the double coset  $NwN$ , where  $w$  is a word of length one.  $Nt_3N = \{Nt_3^n | n \in N\} = [3]$ . We need to find the point stabilizer of 3. So,  $Nt_3N = [3] = \{Nt_3^n | n \in N\} = \{Nt_3N, Nt_1N, Nt_2N\}$ . Since, the point stabilizer of 3 in the subgroup  $N$  is the permutations in  $N$  that fixes 3 and permute the rest of the elements in the set  $\{1, 2, 4, 5\}$ . **Note:**  $N^{(3)} = \{n \in N | t_3^n = t_3\} \geq \langle (1, 2)(4, 5) \rangle$ .

Since  $|N^{(3)}| = 2$  then the number of single cosets in [3] is  $\frac{|N|}{|N^{(3)}|} = \frac{6}{2} = 3$ .

Now, the orbits of  $N^{(3)}$  on  $\{1, 2, 3, 4, 5, 6\}$  are  $\{3\}$ ,  $\{6\}$ ,  $\{1, 2\}$ , and  $\{4, 5\}$ . We choose a representative from each orbit, and determine the double cosets to which  $Nt_3t_i$  belongs for each  $i \in \{1, 3, 4, 6\}$ .

- $Nt_3 \cdot t_3 = Nt_3^2 = Nt_6 \in [6]$ . This double coset will go back to [6]. Since there is one element in this orbit, there is one  $t_i$  that takes [3] to [6].
- $Nt_3 \cdot t_1 = Nt_3t_1 \in [31]$ . This is a new double coset, which will extend the Cayley graph from [3] to [31]. Since there are 2 elements in this orbit, there are 2  $t_i$ s that take [3] to [31].
- $Nt_3 \cdot t_6 = Nt_3t_3^2 = Nt_3^6 = e \in [*]$ . This double coset will go back to [\*]. Since there is one element in this orbit, there is one  $t_i$  that takes [3] to [\*].
- $Nt_3 \cdot t_4 = Nt_3t_4 \in [34]$ . This is a new double coset, which extends our graph from [3] to [34]. Since there are 2 elements in this orbit, there are 2  $t_i$ s that take [3] to [34].

(ii) Word of Length One [6]:

we consider the double coset  $NwN$ , where  $w$  is a word of length one.  $Nt_6N = \{Nt_6^n | n \in N\} = [6]$ . We need to find the point stabilizer of 6. So,  $Nt_6N = [6] = \{Nt_6^n | n \in N\} = \{Nt_6N, Nt_4N, Nt_5N\}$ . Since, the point stabilizer of 6 in the subgroup  $N$  is the permutations in  $N$  that fixes 6 and permute the rest of the elements in the set  $\{1, 2, 4, 5\}$ . **Note:**  $N^{(6)} = \{n \in N | t_6^n = t_6\} \geq \langle (1, 2)(4, 5) \rangle$ .

Since  $|N^{(6)}| = 2$  then the number of single cosets in [6] is  $\frac{|N|}{|N^{(6)}|} = \frac{6}{2} = 3$ .

Now, the orbits of  $N^{(6)}$  on  $\{1, 2, 3, 4, 5, 6\}$  are  $\{3\}$ ,  $\{6\}$ ,  $\{1, 2\}$ , and  $\{4, 5\}$ . We choose a representative from each orbit, and determine the double cosets to which  $Nt_6t_i$

belongs for each  $i \in \{1, 3, 4, 6\}$ .

- $Nt_6 \cdot t_6 = Nt_6^2 = Nt_3 \in [3]$ . This double coset will go back to  $[3]$ . Since there is one element in this orbit, there is one  $t_i$  that takes  $[6]$  to  $[3]$ .
- $Nt_6 \cdot t_1 = Nt_6t_1 \in [61]$ . This is a new double coset, which extends our graph from  $[6]$  to  $[61]$ . Since there are 2 elements in this orbit, there are 2  $t_i$ s that take  $[6]$  to  $[61]$ .
- $Nt_6 \cdot t_3 = Nt_3^2t_3 = Nt_3^6 = e \in [*]$ . This double coset will go back to  $[*]$ . Since there is one element in this orbit, there is one  $t_i$  that takes  $[6]$  to  $[*]$ .
- $Nt_6 \cdot t_4 = Nt_6t_4$  by the relation(II)  $Nt_6t_4 = Nt_1t_3$  then by conjugate  $Nt_1t_3$  by  $n = (1, 3)(4, 6)$  we will get that  $N(t_1t_3)^n = Nt_3t_1$ . So, this double coset will go to  $[31]$ . Since there are 2 elements in this orbit, there are 2  $t_i$ s that take  $[6]$  to  $[31]$ .

### Word of Length Two $[31]$ , $[34]$ , and $[61]$

(i) We are at a new double coset  $[31] = Nt_3t_1N = \{N(t_3t_1)^n | n \in N\}$ . Now, to determine all the single cosets of this double cosets, we need to determine the point stabilizer  $N^{31}$ , this means finding the set of elements that fix 3 and 1 in  $N$  and permute the rest of the elements in the set  $\{2, 5\}$ . **Note:**  $N^{(31)} = \{n \in N | (t_3t_1)^n = t_3t_1\} \geq \langle e \rangle$ . Since  $|N^{(31)}| = 1$  then the number of single cosets in  $[31]$  is  $\frac{|N|}{|N^{(31)}|} = \frac{6}{1} = 6$ . Now, the orbits of  $N^{(31)}$  on  $\{1, 2, 3, 4, 5, 6\}$  are  $\{1\}$ ,  $\{2\}$ ,  $\{3\}$ ,  $\{4\}$ ,  $\{5\}$ , and  $\{6\}$ . We choose a representative from each orbit, and determine the double cosets to which  $Nt_3t_1t_i$  belongs for each  $i \in \{1, 2, 3, 4, 5, 6\}$ .

- $Nt_3t_1 \cdot t_1 = Nt_3t_1^2 = Nt_3t_4 \in [34]$ . This double coset will go back to  $[34]$ . Since there is one element in this orbit, then there will be one  $t_i$  that takes  $[31]$  to  $[34]$ .
- $Nt_3t_1 \cdot t_2 = Nt_3t_5t_4 = Nt_3t_4t_4 = Nt_3t_4^2 = Nt_3t_1 \in [31]$ . This is double coset will collapse. Since there is one element in this orbit, there is one  $t_i$  that takes  $[31]$  to itself.
- $Nt_3t_1 \cdot t_3 = Nt_3t_6t_4 = Nt_4 \in [6]$ . This double coset will go back to  $[6]$ . Since there is one element in this orbit, there is one  $t_i$  that takes  $[31]$  to  $[6]$ .



- $Nt_3t_1 \cdot t_4 = Nt_3 \in [3]$ . This double coset will go back to [3]. Since there is one element in this orbit, there is one  $t_i$  that takes [31] to [3].
- $Nt_3t_1 \cdot t_5 = N\underline{t_3t_1t_2}t_2 = N\underline{t_3t_1t_2} = Nt_3t_1 \in [31]$ . This double coset will collapse. Since there is one element in this orbit, there is one  $t_i$  that takes [31] to itself.
- $Nt_3t_1 \cdot t_6 = Nt_4t_6t_6 = Nt_4t_3 \in [61]$ . This double coset will go back to [61]. Since there is one element in this orbit, there is one  $t_i$  that takes [31] to [61].

(ii) We are at a new double coset  $[34] = Nt_3t_4N = \{N(t_3t_4)^n | n \in N\}$ . Now, to determine all the single cosets of this double cosets, we need to determine the point stabilizer  $N^{(34)}$ , this means finding the set of elements that fix 3 and 4 in  $N$  and permute the rest of the elements in the set  $\{1, 2, 4, 5\}$ . Now, using our relation  $Nt_3t_5 = t_3t_4$ .  
 $\Rightarrow N(t_3t_4)^{(1,2)(4,5)} = Nt_3t_5 = Nt_3t_4 \Rightarrow (1, 2)(4, 5) \in N^{(34)}$ .  
 $\Rightarrow N^{(34)} \geq \langle (1, 2)(4, 5) \rangle$ . Thus,  $|N^{(34)}| = 2$ . So, the number of single cosets in [34] is  $\frac{|N|}{|N^{(34)}|} = \frac{6}{2} = 3$ . In order to find these 3 single cosets, we need to determine the transversals (right coset representatives) of  $N^{(34)}$ . The 3 single distinct cosets of the double coset [34] are:  $\{Nt_3t_4, Nt_2t_4, Nt_1t_5\}$ . Now, we need to find the orbits of  $N^{(34)}$  to advance to the next double coset. From the generator of  $N^{(34)} \geq \langle (1, 2)(4, 5) \rangle$ , the orbits of  $N^{(34)}$  on  $\{1, 2, 3, 4, 5, 6\}$  are:  $\{1, 2\}$ ,  $\{3\}$ ,  $\{4, 5\}$ , and  $\{6\}$ . Considering a representative from each orbit of  $N^{(34)}$ , and determine the double cosets to which  $Nt_3t_4t_i$  belongs for each  $i \in \{1, 3, 4, 6\}$ .

- $Nt_3t_4 \cdot t_1 = Nt_3t_1^3 = Nt_3 \in [3]$ . This double coset will go back to [3]. Since there is one element in this orbit, there is one  $t_i$  that takes [34] to [3].
- $Nt_3t_4 \cdot t_3 \in [343]$ . This this is a new double coset, which extends our graph from [34] to [343]. Since there is one element in this orbit, there is one  $t_i$  that takes [34] to [343].
- $Nt_3t_4 \cdot t_4 = Nt_3t_1 \in [31]$ . This double coset will go back to [31]. Since there is one element in this orbit, there is one  $t_i$  that takes [34] to [31].
- $Nt_3t_4 \cdot t_6 = Nt_3t_3t_1 = Nt_6t_1 \in [61]$ . This double coset will go back to [61]. Since there is one element in this orbit, there is one  $t_i$  that takes [34] to [61].

(iii) We are at a new double coset  $[61] = Nt_6t_1N = \{N(t_6t_1)^n | n \in N\}$ . Now, to determine all the single cosets of this double cosets, we need to determine the point stabilizer  $N^{61}$ , this means finding the set of elements that fix 6 and 1 in  $N$  and permute the rest of the elements in the set  $\{1, 2, 4, 5\}$ . Now, using our relations;

$$\Rightarrow N(t_6t_1)^{(1,2)(4,5)} = Nt_6t_2 = Nt_4t_2t_4t_6 = Nt_4t_2t_3t_1 = Nt_4t_6t_5t_1 = Nt_3t_1t_5t_1 = Nt_2t_3t_1t_6 = Nt_6t_5t_1t_6 = Nt_6t_1 \Rightarrow (1, 2)(4, 5) \in N^{(61)}.$$

$$\Rightarrow N^{(61)} \geq \langle (1, 2)(4, 5) \rangle. \text{ Thus, } |N^{(61)}| = 2. \text{ So, the number of single cosets in } [61] \text{ is } \frac{|N|}{|N^{(61)}|} = \frac{6}{2} = 3. \text{ In order to find these 3 single cosets, we need to determine the transversals (right coset representatives) of } N^{(61)}. \text{ The 3 single distinct cosets of the double coset } [61] \text{ are: } \{Nt_6t_1, Nt_5t_1, Nt_4t_2\}. \text{ Now, we need to find the orbits of } N^{(61)} \text{ to advance to the next double coset. From the generator of } N^{(61)} \geq \langle (1, 2)(4, 5) \rangle, \text{ the orbits of } N^{(61)} \text{ on } \{1, 2, 3, 4, 5, 6\} \text{ are: } \{1, 2\}, \{3\}, \{4, 5\}, \text{ and } \{6\}. \text{ Considering a representative from each orbit of } N^{(61)}, \text{ and determine the double cosets to which } Nt_6t_1t_i \text{ belongs for each } i \in \{1, 3, 4, 6\}.$$

- $Nt_6t_1 \cdot t_1 = Nt_6t_1^2 = Nt_6t_4 = Nt_1t_3 \in [31]$ . This double coset will go back to  $[31]$ . Since there is one element in this orbit, there is one  $t_i$  that takes  $[61]$  to  $[31]$ .
- $Nt_6t_1 \cdot t_3 = Nt_6t_6t_4 = Nt_3t_4 \in [34]$ . This double coset will go back to  $[34]$ . Since there is one element in this orbit, there is one  $t_i$  that takes  $[61]$  to  $[34]$ .
- $Nt_6t_1 \cdot t_4 = Nt_6 \in [6]$ . This double coset will go back to  $[6]$ . Since there is one element in this orbit, there is one  $t_i$  that takes  $[61]$  to  $[6]$ .
- $Nt_6t_1 \cdot t_6 = Nt_3t_3t_1t_3t_3 = Nt_3t_3t_6t_4t_3 = Nt_3t_4t_3 \in [343]$ . So that, this is a new double coset, which extends our graph from  $[61]$  to  $[343]$ . Since there is one element in this orbit, there is one  $t_i$  that takes  $[61]$  to  $[343]$ .

### Word of Length Three [343]:

Again we need to find the point stabilizer of 3, 4 and 3. This is denoted by  $N^{343}$  in this case will be the identity. Therefore, we need to find the permutations in  $N$  that fixes 3, 4 and 3. The group stabilizer,  $N^{(343)}$ . Now, using our relations;

$$\Rightarrow N(t_3t_4t_3)^{(1,2)(4,5)} = Nt_3t_5t_3 = Nt_3t_4t_3 \Rightarrow (1, 2)(4, 5) \in N^{(343)}, \text{ and}$$

$$\Rightarrow N(t_3t_4t_3)^{(1,2,3)(4,5,6)} = Nt_1t_5t_1 = Nt_1t_6t_1 = Nt_1t_3t_3t_1 = Nt_6t_4t_3t_1 = Nt_6t_4t_4t_6$$

$= N\underline{t_6t_1t_6} = Nt_3t_3\underline{t_1t_3t_3} = Nt_3t_3t_6t_4t_3 = Nt_3t_4t_3 \Rightarrow (1, 2, 3)(4, 5, 6) \in N^{(343)}$ .  
 $\Rightarrow N^{(343)} \geq \langle (1, 2, 3)(4, 5, 6), (1, 2)(4, 5) \rangle$ . Thus,  $|N^{(343)}| = 6$ . So, the number of single cosets in  $[343]$  is  $\frac{|N|}{|N^{(343)}|} = \frac{6}{6} = 1$ . In order to find these 1 single coset, we need to determine the transversals (right coset representatives) of  $N^{(343)}$ . A single distinct cosets of the double coset  $[343]$  are:  $\{Nt_3t_4t_3\}$ . Now, we need to find the orbits of  $N^{(343)}$  to advance to the next double coset. From the generator of  $N^{(343)} \geq \langle (1, 2, 3)(4, 5, 6), (1, 2)(4, 5) \rangle$ , the orbits of  $N^{(343)}$  on  $\{1, 2, 3, 4, 5, 6\}$  are:  $\{1, 2, 3\}$  and  $\{4, 5, 6\}$ . Considering a representative from each orbit of  $N^{(343)}$ , we will choose the following representative from each orbit:

- $Nt_3t_4t_3 \cdot t_3 = Nt_3t_4t_6 = Nt_3t_3t_1 = Nt_6t_1 \in [61]$ . This double coset will go back to  $[61]$ . Since there are 3 elements in this orbit, there are 3  $t_i$ s that take  $[343]$  to  $[61]$ .
- $Nt_3t_4t_3 \cdot t_6 = Nt_3t_4 \in [34]$ . This double coset go back to  $[34]$ . Since there are 3 elements in this orbit, there are 3  $t_i$ s that take  $[343]$  to  $[34]$ .

**Conclusion:**

The double coset enumeration gives that

$$|G| \leq \left( \frac{|N|}{|N|} + \frac{|N|}{|N^{(3)}|} + \frac{|N|}{|N^{(31)}|} + \frac{|N|}{|N^{(34)}|} + \frac{|N|}{|N^{(6)}|} + \frac{|N|}{|N^{(61)}|} + \frac{|N|}{|N^{(343)}|} \right) \times |N| = (1 + 3 + 3 + 3 + 6 + 3 + 1) \times 6 = (20 \times 6) = 120.$$

A Cayley diagram of  $G$  over  $S_3$  is given below..

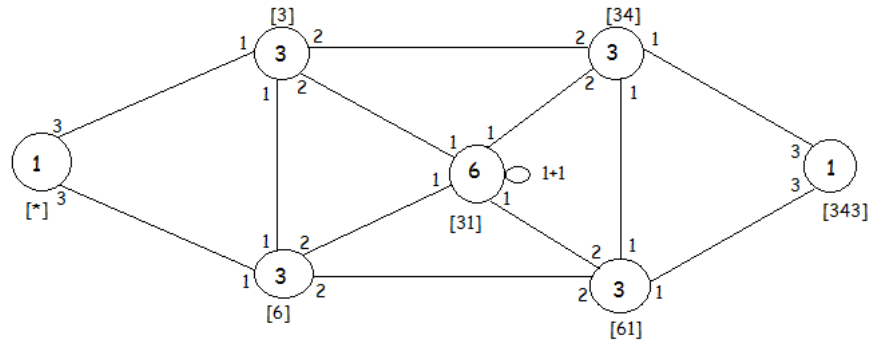

Figure 6.2: Cayley Diagram for  $S_5$  Over  $S_3$

## 6.4 Construction Of $L_2(8)$

### Double Coset Enumeration $L_2(8)$ Over $2^2$

We take the progenitor  $2^{*4} : 2^2$ , where  $2^{*4}$  is the free product of 4 copies of the cyclic groups of order 2, and  $2^2$  is the group of automorphisms of  $2^{*4}$  which permutes the four symmetric generators by conjugation and factor it by the three relations

$$(xyx)^7 t_1 t_3 t_1 t_3 t_1 t_3 t_1 = 1, (x)^9 t_1 t_2 t_1 t_2 t_1 t_2 t_1 t_2 t_1 = 1, \text{ and } (xy)^3 t_1 t_4 t_1 = 1.$$

The double coset enumeration partitions the image of the group  $G$  as a union double cosets  $NgN$  where  $g \in 2^{*4} : 2^2$ . Thus, we can find the set of elements  $g_1, g_2, \dots$  of  $G$  such that  $G = Ng_1N \cup Ng_2N \cup \dots$ , and for each  $i$ , we have  $g_i = p_i w_i$ , where  $p_i \in N$ , and  $w_i$  is a word in the  $t_i$ 's. Hence, the double coset decomposition is given by

$$G = Nw_1N \cup Nw_2N \cup Nw_3N \cup \dots,$$

where  $w_1 = e$  (the identity). We perform a double coset enumeration of the group  $\frac{2^{*4} : 2^2}{[(xyx)t]^7, [xt]^9, [(xy)t]^3}$  over  $2^2$ . We will show

$$G = \frac{2^{*4} : 2^2}{[(xyx)t]^7, [xt]^9, [(xy)t]^3} \cong L_2(8).$$

A symmetric presentation of the progenitor  $2^{*4} : 2^2$  is given by:

$$2^{*4} : 2^2 \cong$$

$$\text{G}\langle x, y, t \rangle := \text{Group}\langle x, y, t \mid x^2, y^2, (x, y), t^2 \rangle;$$

$G$  factored by  $(x * y * x * t)^7$ ,  $(x * t)^9$ , and  $(x * y * t)^3$  which simplify to  $(xyx)^7 t_1 t_3 t_1 t_3 t_1 t_3 t_1 = 1$ ,  $(x)^9 t_1 t_2 t_1 t_2 t_1 t_2 t_1 t_2 t_1 = 1$ , and  $(xy)^3 t_1 t_4 t_1 = 1$ . Show simplification where  $N \cong 2^2 = \langle x, y \rangle$ , where  $x \sim (1, 2)(3, 4)$  and  $y \sim (1, 3)(2, 4)$ , and  $t = t_1$ .

#### Using computer-based program - Magma :

1. The order of the group,  $|G|$  is equal to 504.
2. There are 36 double cosets in this double cosets enumeration of  $G$  over  $N$ .

#### Relations

We see that

$$(I) [(xyx)t]^7 = 1 \Rightarrow (xyx)^7 t^{(xyx)^6} t^{(xyx)^5} t^{(xyx)^4} t^{(xyx)^3} t^{(xyx)^2} t^{(xyx)^1} t^{(xyx)^0} = 1 \\ \Rightarrow (1, 3)(2, 4) t_1 t_3 t_1 t_3 t_1 t_3 t_1 = 1 \Rightarrow N t_1 t_3 t_1 t_3 t_1 t_3 t_1 = 1.$$

Moreover, if we conjugate the previous relation by all elements in  $2^2 = \{e, (1, 2)(3, 4), (1, 3)(2, 4), (1, 4)(2, 3)\}$ , we obtain:

1.  $((1, 3)(2, 4)t_1t_3t_1t_3t_1t_3t_1 = 1)^e \Rightarrow (1, 3)(2, 4)t_1t_3t_1t_3t_1t_3t_1 = 1.$
2.  $((1, 3)(2, 4)t_1t_3t_1t_3t_1t_3t_1 = 1)^{(1,2)(3,4)} \Rightarrow (2, 4)(1, 3)t_2t_4t_2t_4t_2t_4t_2 = 1.$
3.  $((1, 3)(2, 4)t_1t_3t_1t_3t_1t_3t_1 = 1)^{(1,3)(2,4)} \Rightarrow (3, 1)(4, 2)t_3t_1t_3t_1t_3t_1t_3 = 1.$
4.  $((1, 3)(2, 4)t_1t_3t_1t_3t_1t_3t_1 = 1)^{(1,4)(2,3)} \Rightarrow (4, 2)(3, 1)t_4t_2t_4t_2t_4t_2t_4 = 1.$

$$(II) [xt]^9 = 1 \Rightarrow (x)^9t^{(x)^8}t^{(x)^7}t^{(x)^6}t^{(x)^5}t^{(x)^4}t^{(x)^3}t^{(x)^2}t^{(x)^1}t^{(x)^0} = 1$$

$$\Rightarrow (1, 2)(3, 4)t_1t_2t_1t_2t_1t_2t_1t_2t_1 = 1 \Rightarrow Nt_1t_2t_1t_2t_1t_2t_1t_2t_1 = 1.$$

Moreover, if we conjugate the previous relation by all elements in  $2^2$ , we obtain

1.  $((1, 2)(3, 4)t_1t_2t_1t_2t_1t_2t_1t_2t_1 = 1)^e \Rightarrow (1, 2)(3, 4)t_1t_2t_1t_2t_1t_2t_1t_2t_1 = 1.$
2.  $((1, 2)(3, 4)t_1t_2t_1t_2t_1t_2t_1t_2t_1 = 1)^{(1,2)(3,4)} \Rightarrow (2, 1)(4, 3)t_2t_1t_2t_1t_2t_1t_2t_1t_2 = 1.$
3.  $((1, 2)(3, 4)t_1t_2t_1t_2t_1t_2t_1t_2t_1 = 1)^{(1,3)(2,4)} \Rightarrow (3, 4)(1, 2)t_3t_4t_3t_4t_3t_4t_3t_4t_3 = 1.$
4.  $((1, 2)(3, 4)t_1t_2t_1t_2t_1t_2t_1t_2t_1 = 1)^{(1,4)(2,3)} \Rightarrow (4, 3)(2, 1)t_4t_3t_4t_3t_4t_3t_4t_3t_4 = 1.$

$$(III) [(xy)t]^3 = 1 \Rightarrow (xy)^3t^{(xy)^2}t^{(xy)^1}t^{(xy)^0} = 1$$

$$\Rightarrow (1, 4)(3, 2)t_1t_4t_1 = 1 \Rightarrow Nt_1t_4t_1 = 1.$$

Moreover, if we conjugate the previous relation by all elements in  $2^2$ , we obtain

1.  $((1, 4)(3, 2)t_1t_4t_1 = 1)^e \Rightarrow (1, 4)(3, 2)t_1t_4t_1 = 1$
2.  $((1, 4)(3, 2)t_1t_4t_1 = 1)^{(1,2)(3,4)} \Rightarrow (2, 3)(4, 1)t_2t_3t_2 = 1$
3.  $((1, 4)(3, 2)t_1t_4t_1 = 1)^{(1,3)(2,4)} \Rightarrow (3, 2)(1, 4)t_3t_2t_3 = 1$
4.  $((1, 4)(3, 2)t_1t_4t_1 = 1)^{(1,4)(2,3)} \Rightarrow (4, 1)(2, 3)t_4t_1t_4 = 1$

### Double Coset $[*]$ :

We start with the double coset  $NeN$ , where  $e$  is the word of length zero, denoted by  $[*]$ . We have

$$NeN = \{Nen : n \in N\} = \{Ne\} = \{N\}$$

So, the double coset  $NeN$  consists of the single coset  $N$ . Thus,  $\frac{|N|}{|N|} = \frac{4}{4} = 1$ .

Note, since  $N$  is transitive on  $\{1, 2, 3, 4\}$ , we take a representative coset  $N$  from  $[*]$  and a representative from  $\{1, 2, 3, 4\}$  and determine the double coset to which  $Nt_i$  belongs, where  $i \in \{1, 2, 3, 4\}$ . We consider  $i = 1$ , so  $Nt_1$  is the representative coset, and hence we will have a new double coset  $Nt_1N$  which can be denoted by  $[1]$ . There will be four possible  $t_i$ s in  $[*]$  that will advance to the next double cosets  $[1]$ .

### Word of Length One $[1]$ :

We consider the double coset  $NwN$ , where  $w$  is a word of length one.  $Nt_1N = \{Nt_1^n | n \in N\} = [1]$ . We need to find the point stabilizer of 1. So,  $Nt_1N = [1] = \{Nt_1^n | n \in N\} = \{Nt_1N, Nt_2N, Nt_3N, Nt_4N\}$ . Since, the point stabilizer of 1 in the subgroup  $N$  is the permutations in  $N$  that fix 1 and permute the rest of the elements in the set  $\{1, 2, 3, 4\}$ .

**Note:**  $N^{(1)} = \{n \in N | t_1^n = t_1\} \geq \langle e \rangle$ .

Since  $|N^{(1)}| = 1$  then the number of single cosets in  $[1]$  is  $\frac{|N|}{|N^{(1)}|} = \frac{4}{1} = 4$ .

Now, the orbits of  $N^{(1)}$  on  $\{1, 2, 3, 4\}$  are  $\{1\}$ ,  $\{2\}$ ,  $\{3\}$ , and  $\{4\}$ . We choose a representative from each orbit, and determine the double cosets to which  $Nt_1t_i$  belongs for each  $i \in \{1, 2, 3, 4\}$ .

- $Nt_1 \cdot t_1 = Nt_1^2 = N \in [*]$ . This double coset will go back to  $[*]$ . Since there is one element in this orbit, there is one  $t_i$  that takes  $[1]$  to  $[*]$ .
- $Nt_1 \cdot t_2 = Nt_1t_2 \in [12]$ . This is a new double coset, which will extend the Cayley graph from  $[1]$  to  $[12]$ . Since there is one element in this orbit, there is one  $t_i$  that takes  $[1]$  to  $[12]$ .
- $Nt_1 \cdot t_3 = Nt_1t_3 \in [13]$ . This is a new double coset, which extends our graph from  $[1]$  to  $[13]$ . Since there is one element in this orbit, there is one  $t_i$  that takes  $[1]$  to  $[13]$ .
- $Nt_1 \cdot t_4 = Nt_1t_4 = Nt_1 \in [1]$ . This double coset will collapse. Since there is one element in this orbit, there is one  $t_i$  that takes  $[1]$  to  $[1]$ .

### Word of Length Two $[12]$ , and $[13]$ :

(i) We are at a new double coset  $[12]$ ,  $Nt_1t_2N = \{N(t_1t_2)^n | n \in N\}$ . Now, to determine all the single cosets of this double coset, we need to determine the point stabilizer  $N^{12}$ ,

this means finding the set of elements that fix 1 and 2 in  $N$  and permute the rest of the elements in the set  $\{1, 2, 3, 4\}$ . **Note:**  $N^{(12)} = \{n \in N | (t_1 t_2)^n = t_1 t_2\} \geq \langle e \rangle$ .

Since  $|N^{(12)}| = 1$  then the number of single cosets in  $[12]$  is  $\frac{|N|}{|N^{(12)}|} = \frac{4}{1} = 4$ .

Now, the orbits of  $N^{(12)}$  on  $\{1, 2, 3, 4\}$  are  $\{1\}$ ,  $\{2\}$ ,  $\{3\}$ , and  $\{4\}$ . We choose a representative from each orbit, and determine the double cosets to which  $Nt_1 t_2 t_i$  belongs for each  $i \in \{1, 2, 3, 4\}$ .

- $Nt_1 t_2 \cdot t_1 = Nt_1 t_2 t_1 \in [121]$ . This is a new double coset, which extends our graph from  $[12]$  to  $[121]$ . Since there is one element in this orbit, there is one  $t_i$  that takes  $[12]$  to  $[121]$ .
- $Nt_1 t_2 \cdot t_2 = Nt_1 t_2^2 \in [1]$ . This double coset will go back to  $[1]$ . Since there is one element in this orbit, there is one  $t_i$  that takes  $[12]$  to  $[1]$ .
- $Nt_1 t_2 \cdot t_3 = Nt_1 t_2 t_3 = Nt_4 t_2 \in [13]$ . This double coset will go to  $[13]$ . Since there is one element in this orbit, there is one  $t_i$  that takes  $[12]$  to  $[13]$ .
- $Nt_1 t_2 \cdot t_4 \in [124]$ . So, this is a new double coset, which extends our graph from  $[12]$  to  $[124]$ . Since there is one element in this orbit, there is one  $t_i$  that takes  $[12]$  to  $[124]$ .

(ii) We are at a new double coset  $[13]$ ,  $Nt_1 t_3 N = \{N(t_1 t_3)^n | n \in N\}$ . Now, to determine all the single cosets of this double cosets, we need to determine the point stabilizer  $N^{13}$ , this means finding the set of elements that fix 1 and 3 in  $N$  and permute the rest of the elements in the set  $\{1, 2, 3, 4\}$ . **Note:**  $N^{(13)} = \{n \in N | (t_1 t_3)^n = t_1 t_3\} \geq \langle e \rangle$ .

Since  $|N^{(13)}| = 1$  then the number of single cosets in  $[13]$  is  $\frac{|N|}{|N^{(13)}|} = \frac{4}{1} = 4$ .

Now, the orbits of  $N^{(13)}$  on  $\{1, 2, 3, 4\}$  are  $\{1\}$ ,  $\{2\}$ ,  $\{3\}$ , and  $\{4\}$ . We choose a representative from each orbit, and determine the double cosets to which  $Nt_1 t_2 t_i$  belongs for each  $i \in \{1, 2, 3, 4\}$ .

- $Nt_1 t_3 \cdot t_1 = Nt_1 t_3 t_1 \in [131]$ . This is a new double coset, which extends our graph from  $[13]$  to  $[131]$ . Since there is one element in this orbit, there is one  $t_i$  that takes  $[13]$  to  $[131]$ .
- $Nt_1 t_3 \cdot t_3 = Nt_1 t_3^2 \in [1]$ . This double coset will go back to  $[1]$ . Since there is one element in this orbit, there is one  $t_i$  that takes  $[13]$  to  $[1]$ .

- $Nt_1t_3 \cdot t_2 = Nt_1t_3t_2 = Nt_4t_3 \in [12]$ . This double coset will go to [12]. Since there is one element in this orbit, there is one  $t_i$  that takes [13] to [12].
- $Nt_1t_3 \cdot t_4 \in [134]$ . So, this is a new double coset, which extends our graph from [13] to [134]. Since there is one element in this orbit, there is one  $t_i$  that takes [13] to [134].

**Word of Length Three** [121], [124], [131] and [134]:

(i) We are at a new double coset [121],  $Nt_1t_2t_1N = \{N(t_1t_2t_1)^n | n \in N\}$ . Now, to determine all the single cosets of this double cosets, we need to determine the point stabilizer  $N^{121}$ , this means finding the set of elements that fix 1, 2, and 1 in  $N$  and permute the rest of the elements in the set  $\{1, 2, 3, 4\}$ . **Note:**  $N^{(121)} = \{n \in N | (t_1t_2t_1)^n = t_1t_2t_1\} \geq \langle e \rangle$ . Since  $|N^{(121)}| = 1$  then the number of single cosets in [121] is  $\frac{|N|}{|N^{(121)}|} = \frac{4}{1} = 4$ . Now, the orbits of  $N^{(121)}$  on  $\{1, 2, 3, 4\}$  are  $\{1\}$ ,  $\{2\}$ ,  $\{3\}$ , and  $\{4\}$ . We choose a representative from each orbit, and determine the double cosets to which  $Nt_1t_2t_1t_i$  belongs for each  $i \in \{1, 2, 3, 4\}$ .

- $Nt_1t_2t_1 \cdot t_1 = Nt_1t_2t_1^2 \in [12]$ . This double coset will go back to [12]. Since there is one element in this orbit, there is one  $t_i$  that takes [121] to [12].
- $Nt_1t_2t_1 \cdot t_2 \in [1212]$ . This is a new double coset, which extends our graph from [121] to [1212]. Since there is one element in this orbit, there is one  $t_i$  that takes [121] to [1212].
- $Nt_1t_2t_1 \cdot t_3 \in [1213]$ . This is a new double coset, which extends our graph from [121] to [1213]. Since there is one element in this orbit, there is one  $t_i$  that takes [121] to [1213].
- $Nt_1t_2t_1 \cdot t_4 = Nt_1t_2t_1t_4 = Nt_4t_3t_1 \in [124]$ . This double coset will go to [124]. Since there is one element in this orbit, there is one  $t_i$  that takes [121] to [124].

(ii) We are at a new double coset [124],  $Nt_1t_2t_4N = \{N(t_1t_2t_4)^n | n \in N\}$ . Now, to determine all the single cosets of this double cosets, we need to determine the point stabilizer of  $N^{124}$ , this means finding the set of elements that fix 1, 2 and, 4 in  $N$  and permute the rest of the elements in the set  $\{1, 2, 3, 4\}$ . **Note:**  $N^{(124)} = \{n \in N | (t_1t_2t_4)^n = t_1t_2t_4\} \geq \langle e \rangle$ . Since  $|N^{(124)}| = 1$  then the number of single cosets in [124] is  $\frac{|N|}{|N^{(124)}|} = \frac{4}{1} = 4$ .



Now, the orbits of  $N^{(124)}$  on  $\{1, 2, 3, 4\}$  are  $\{1\}$ ,  $\{2\}$ ,  $\{3\}$ , and  $\{4\}$ . We choose a representative from each orbit, and determine the double cosets to which  $Nt_1t_2t_4t_i$  belongs for each  $i \in \{1, 2, 3, 4\}$ .

- $Nt_1t_2t_4 \cdot t_1 = Nt_1t_2t_4t_1 = Nt_4t_3t_4 \in [121]$ . This double coset will go to  $[121]$ . Since there is one element in this orbit, there is one  $t_i$  that takes  $[124]$  to  $[121]$ .
- $Nt_1t_2t_4 \cdot t_2 \in [1242]$ . This is a new double coset, which extends our graph from  $[124]$  to  $[1242]$ . Since there is one element in this orbit, there is one  $t_i$  that takes  $[124]$  to  $[1242]$ .
- $Nt_1t_2t_4 \cdot t_3 \in [1243]$ . This is a new double coset, which extends our graph from  $[124]$  to  $[1243]$ . Since there is one element in this orbit, there is one  $t_i$  that extend  $[124]$  to  $[1243]$ .
- $Nt_1t_2t_4 \cdot t_4 = Nt_1t_2 \in [12]$ . This double coset will go back to  $[12]$ . Since there is one element in this orbit, there is one  $t_i$  that takes  $[124]$  to  $[12]$ .

(iii) We are at a new double coset  $[131]$ ,  $Nt_1t_3t_1N = \{N(t_1t_3t_1)^n | n \in N\}$ . Now, to determine all the single cosets of this double cosets, we need to determine the point stabilizer  $N^{131}$ , this means finding the set of elements that fix 1, 3, and 1 in  $N$  and permute the rest of the elements in the set  $\{1, 2, 3, 4\}$ . **Note:**  $N^{(131)} = \{n \in N | (t_1t_3t_1)^n = t_1t_3t_1\} \geq \langle e \rangle$ . Since  $|N^{(131)}| = 1$  then the number of single cosets in  $[131]$  is  $\frac{|N|}{|N^{(131)}|} = \frac{4}{1} = 4$ . Now, the orbits of  $N^{(131)}$  on  $\{1, 2, 3, 4\}$  are  $\{1\}$ ,  $\{2\}$ ,  $\{3\}$ , and  $\{4\}$ . We choose a representative from each orbit, and determine the double cosets to which  $Nt_1t_3t_1t_i$  belongs for each  $i \in \{1, 2, 3, 4\}$ .

- $Nt_1t_3t_1 \cdot t_1 = Nt_1t_3t_1^2 \in [13]$ . This double coset will go back to  $[13]$ . Since there is one element in this orbit, there is one  $t_i$  that takes  $[131]$  to  $[13]$ .
- $Nt_1t_3t_1 \cdot t_3 = Nt_1t_3t_1t_3 = Nt_1t_3t_1 \in [131]$ . This double coset will collapse. Since there is one element in this orbit, there is one  $t_i$  that extend  $[131]$  to itself.
- $Nt_1t_3t_1 \cdot t_2 \in [1312]$ . This is a new double coset, which extends our graph from  $[131]$  to  $[1312]$ . Since there is one element in this orbit, there is one  $t_i$  that takes  $[131]$  to  $[1312]$ .

- $Nt_1t_3t_1 \cdot t_4 = Nt_1t_3t_1t_4 = Nt_4t_2t_1 \in [134]$ . This double coset will go to [134]. Since there is one element in this orbit, there is one  $t_i$  that takes [131] to [134].

(iv) We are at a new double coset [134],  $Nt_1t_3t_4N = \{N(t_1t_3t_4)^n | n \in N\}$ . Now, to determine all the single cosets of this double cosets, we need to determine the point stabilizer of  $N^{134}$ , this means finding the set of elements that fix 1, 3 and 4 in  $N$  and permute the rest of the elements in the set  $\{1, 2, 3, 4\}$ . **Note:**  $N^{(134)} = \{n \in N | (t_1t_3t_4)^n = t_1t_3t_4\} \geq \langle e \rangle$ . Since  $|N^{(134)}| = 1$  then the number of single cosets in [134] is  $\frac{|N|}{|N^{(134)}|} = \frac{4}{1} = 4$ . Now, the orbits of  $N^{(134)}$  on  $\{1, 2, 3, 4\}$  are  $\{1\}$ ,  $\{2\}$ ,  $\{3\}$ , and  $\{4\}$ . We choose a representative from each orbit, and determine the double cosets to which  $Nt_1t_3t_4t_i$  belongs for each  $i \in \{1, 2, 3, 4\}$ .

- $Nt_1t_3t_4 \cdot t_1 = Nt_1t_3t_4t_1 = Nt_4t_2t_4 \in [131]$ . This double coset will go back to [131]. Since there is one element in this orbit, there is one  $t_i$  that takes [134] to [131].
- $Nt_1t_3t_4 \cdot t_2 \in [1342]$ . This is a new double coset, which extends our graph from [134] to [1342]. Since there is one element in this orbit, there is one  $t_i$  that takes [134] to [1342].
- $Nt_1t_3t_4 \cdot t_3 \in [1343]$ . This is a new double coset, which extends our graph from [131] to [1343]. Since there is one element in this orbit, there is one  $t_i$  that takes [131] to [1343].
- $Nt_1t_3t_4 \cdot t_4 = Nt_1t_3 \in [13]$ . So that, this double coset will go back to [13]. Since there is one element in this orbit, there is one  $t_i$  that takes [131] to [13].

**Word of Length four** [1212], [1213], [1242], [1243], [1312], [1342] **and** [1343]:

(i) We are at a new double coset [1212],  $Nt_1t_2t_1t_2N = \{N(t_1t_2t_1t_2)^n | n \in N\}$ . Now, to determine all the single cosets of this double cosets, we need to determine the point stabilizer  $N^{1212}$ , this means finding the set of elements that fix 1, 2, 1, and 2 in  $N$  and permute the rest of the elements in the set  $\{1, 2, 3, 4\}$ .

**Note:**  $N^{(1212)} = \{n \in N | (t_1t_2t_1t_2)^n = t_1t_2t_1t_2\} \geq \langle e \rangle$ .

Since  $|N^{(1212)}| = 1$  then the number of single cosets in [1212] is  $\frac{|N|}{|N^{(1212)}|} = \frac{4}{1} = 4$ .

Now, the orbits of  $N^{(1212)}$  on  $\{1, 2, 3, 4\}$  are  $\{1\}$ ,  $\{2\}$ ,  $\{3\}$ , and  $\{4\}$ . We choose a representative from each orbit, and determine the double cosets to which  $Nt_1t_2t_1t_2t_i$  belongs for each  $i \in \{1, 2, 3, 4\}$ .

- $Nt_1t_2t_1t_2 \cdot t_1 = N\underline{t_1t_2t_1t_2t_1} = Nt_1t_2t_1t_2 \in [1212]$ . This is double coset will collapse. Since there is one element in this orbit, there is one  $t_i$  that takes  $[1212]$  to  $[1212]$ .
- $Nt_1t_2t_1t_2 \cdot t_2 \in [121]$ . This double coset will go back to  $[121]$ . Since there is one element in this orbit, there is one  $t_i$  that takes  $[1212]$  to  $[121]$ .
- $Nt_1t_2t_1t_2 \cdot t_3 = Nt_1t_2t_1\underline{t_2t_3} = Nt_4t_3t_4t_2 \in [1213]$ . This double coset will go to  $[1213]$ . Since there is one element in this orbit, there is one  $t_i$  that takes  $[1212]$  to  $[1213]$ .
- $Nt_1t_2t_1t_2 \cdot t_4 \in [12124]$ . So, this is a new double coset, which extends our graph from  $[1212]$  to  $[12124]$ . Since there is one element in this orbit, there is one  $t_i$  that takes  $[1212]$  to  $[12124]$ .

(ii) We are at a new double coset  $[1213]$ ,  $Nt_1t_2t_1t_3N = \{N(t_1t_2t_1t_3)^n | n \in N\}$ . Now, to determine all the single cosets of this double cosets, we need to determine the point stabilizer  $N^{1213}$ , this means finding the set of elements that fix 1, 2, 1, and 3 in  $N$  and permute the rest of the elements in the set  $\{1, 2, 3, 4\}$ .

**Note:**  $N^{(1213)} = \{n \in N | (t_1t_2t_1t_3)^n = t_1t_2t_1t_3\} \geq \langle e \rangle$ .

Since  $|N^{(1213)}| = 1$  then the number of single cosets in  $[1213]$  is  $\frac{|N|}{|N^{(1213)}|} = \frac{4}{1} = 4$ .

Now, the orbits of  $N^{(1213)}$  on  $\{1, 2, 3, 4\}$  are  $\{1\}$ ,  $\{2\}$ ,  $\{3\}$ , and  $\{4\}$ . We choose a representative from each orbit, and determine the double cosets to which  $Nt_1t_2t_1t_3t_i$  belongs for each  $i \in \{1, 2, 3, 4\}$ .

- $Nt_1t_2t_1t_3 \cdot t_1 \in [12131]$ . This is a new double coset, which extends our graph from  $[1213]$  to  $[12131]$ . Since there is one element in this orbit, there is one  $t_i$  that takes  $[1213]$  to  $[12131]$ .
- $Nt_1t_2t_1t_3 \cdot t_2 = Nt_1t_2t_1\underline{t_3t_2} = Nt_4t_3t_4t_3 \in [1212]$ . This double coset which will go to  $[1212]$ . Since there is one element in this orbit, there is one  $t_i$  that extend  $[1213]$  to  $[1212]$ .
- $Nt_1t_2t_1t_3 \cdot t_3 = Nt_1t_2t_1 \in [121]$ . This double coset will go back to  $[121]$ . Since there is one element in this orbit, there is one  $t_i$  that takes  $[1213]$  to  $[121]$ .
- $Nt_1t_2t_1t_3 \cdot t_4 \in [12134]$ . This is a new double coset, which extends our graph from  $[1213]$  to  $[12134]$ . Since there is one element in this orbit, there is one  $t_i$  that takes  $[1213]$  to  $[12134]$ .

(iii) We are at a new double coset  $[1242]$ ,  $Nt_1t_2t_4t_2N = \{N(t_1t_2t_4t_2)^n | n \in N\}$ . Now, to determine all the single cosets of this double cosets, we need to determine the point stabilizer  $N^{124} = e$ , this means finding the set of elements that fix 1, 2, 4, and 2 in  $N$ . The coset stabilizers of the coset  $Nt_1t_2t_4t_2$ ,  $N^{(1242)}$ . Now, using our relations;  
 $\Rightarrow N(t_1t_2t_4t_2)^{(1,3)(2,4)} = Nt_3t_4t_2t_4 = Nt_3t_2t_4t_2t_4 = Nt_1t_2t_4t_2 \Rightarrow (1,3)(2,4) \in N^{(1242)}$ ,  
 $\Rightarrow N^{(1242)} \geq \langle (1,3)(2,4) \rangle$ . Thus,  $|N^{(1242)}| = 2$ . Since  $|N^{(1242)}| = 2$  then the number of single cosets in  $[1242]$  is  $\frac{|N|}{|N^{(1242)}|} = \frac{4}{2} = 2$ .  
 Now, the orbits of  $N^{(1242)}$  on  $\{1, 2, 3, 4\}$  are  $\{1, 3\}$  and  $\{2, 4\}$ . We choose a representative from each orbit call, and determine the double cosets to which  $Nt_1t_2t_4t_2t_i$  belongs for each  $i \in \{2, 3\}$ .

- $Nt_1t_2t_4t_2 \cdot t_3 = Nt_1t_2t_4t_2t_3 = Nt_4t_3t_1t_2 \in [1243]$ . This double coset will sent to  $[1243]$ . Since there are two elements in this orbit, then there will be two  $t'_i$ s that take  $[1242]$  to  $[1243]$ .
- $Nt_1t_2t_4t_2 \cdot t_2 \in [124]$ . This double coset will go back to  $[124]$ . Since there are two elements in this orbit, then there will be two  $t'_i$ s that take  $[1242]$  to  $[124]$ .

(iv) We are at a new double coset  $[1243]$ ,  $Nt_1t_2t_4t_3N = \{N(t_1t_2t_4t_3)^n | n \in N\}$ . Now, to determine all the single cosets of this double cosets, we need to determine the point stabilizer  $N^{1243}$ , this means finding the set of elements that fix 1, 2, 4, and 3 in  $N$  and permute the rest of the elements in the set  $\{1, 2, 3, 4\}$ .

**Note:**  $N^{(1243)} = \{n \in N | (t_1t_2t_4t_3)^n = t_1t_2t_4t_3\} \geq \langle e \rangle$ .

Since  $|N^{(1243)}| = 1$  then the number of single cosets in  $[1243]$  is  $\frac{|N|}{|N^{(1243)}|} = \frac{4}{1} = 4$ .

Now, the orbits of  $N^{(1243)}$  on  $\{1, 2, 3, 4\}$  are  $\{1\}$ ,  $\{2\}$ ,  $\{3\}$ , and  $\{4\}$ . We choose a representative from each orbit, and determine the double cosets to which  $Nt_1t_2t_4t_3t_i$  belongs for each  $i \in \{1, 2, 3, 4\}$ .

- $Nt_1t_2t_4t_3 \cdot t_1 \in [12431]$ . This is a new double coset, which extends our graph from  $[1243]$  to  $[12431]$ . Since there is one element in this orbit, there is one  $t_i$  that takes  $[1243]$  to  $[12431]$ .
- $Nt_1t_2t_4t_3 \cdot t_2 = Nt_1t_2t_4t_3t_2 = Nt_4t_3t_1t_3 \in [1242]$ . This double coset will go to  $[1242]$ . Since there is one element in this orbit, there is one  $t_i$  that takes  $[1243]$  to  $[1242]$ .

- $Nt_1t_2t_4t_3 \cdot t_3 = Nt_1t_2t_4 \in [124]$ . This double coset will go back to  $[124]$ . Since there is one element in this orbit, there is one  $t_i$  that takes  $[1243]$  to  $[124]$ .
- $Nt_1t_2t_4t_3 \cdot t_4 \in [12434]$ . This is a new double coset, which extends our graph from  $[1243]$  to  $[12434]$ . Since there is one element in this orbit, there is one  $t_i$  that takes  $[1243]$  to  $[12434]$ .

(v) We are at a new double coset  $[1312]$ ,  $Nt_1t_3t_1t_2N = \{N(t_1t_3t_1t_2)^n | n \in N\}$ . Now, to determine all the single cosets of this double cosets, we need to determine the point stabilizer  $N^{1312} = e$ , this means finding the set of elements that fix 1, 3, 1, and 2 in  $N$ . The coset stabilizers of the coset  $Nt_1t_3t_1t_2$ ,  $N^{(1312)}$ . Now, using our relations;  
 $\Rightarrow N(t_1t_3t_1t_2)^{(1,4)(2,3)} = Nt_4t_2t_4t_3 = Nt_1t_3t_1t_3t_2 = Nt_1t_3t_1t_2 \Rightarrow (1,4)(2,3) \in N^{(1312)}$ ,  
 $\Rightarrow N^{(1312)} \geq \langle (1,4)(2,3) \rangle$ . Thus,  $|N^{(1312)}| = 2$ . Since  $|N^{(1312)}| = 2$  then the number of single cosets in  $[1312]$  is  $\frac{|N|}{|N^{(1312)}|} = \frac{4}{2} = 2$ .  
 Now, the orbits of  $N^{(1312)}$  on  $\{1, 2, 3, 4\}$  are  $\{1, 4\}$ , and  $\{2, 3\}$ . We choose a representative from each orbit call, and determine the double cosets to which  $Nt_1t_3t_1t_2t_i$  belongs for each  $i \in \{1, 2\}$ .

- $Nt_1t_3t_1t_2 \cdot t_1 \in [13121]$ . This is a new double coset, which extends our graph from  $[1312]$  to  $[13121]$ . Since there are two element in this orbit, there are two  $t_i$ s that take  $[1312]$  to  $[13121]$ .
- $Nt_1t_3t_1t_2 \cdot t_2 \in [131]$ . This double coset will go back to  $[131]$ . Since there are two elements in this orbit, there are two  $t_i$ s that take  $[1312]$  to  $[131]$ .

(vi) We are at a new double coset  $[1342]$ ,  $Nt_1t_3t_4t_2N = \{N(t_1t_3t_4t_2)^n | n \in N\}$ . Now, to determine all the single cosets of this double cosets, we need to determine the point stabilizer  $N^{1342}$ , this means finding the set of elements that fix 1, 3, 4, and 2 in  $N$  and permute the rest of the elements in the set  $\{1, 2, 3, 4\}$ .

**Note:**  $N^{(1342)} = \{n \in N | (t_1t_3t_4t_2)^n = t_1t_3t_4t_2\} \geq \langle e \rangle$ .

Since  $|N^{(1342)}| = 1$  then the number of single cosets in  $[1342]$  is  $\frac{|N|}{|N^{(1342)}|} = \frac{4}{1} = 4$ .

Now, the orbits of  $N^{(1342)}$  on  $\{1, 2, 3, 4\}$  are  $\{1\}$ ,  $\{2\}$ ,  $\{3\}$ , and  $\{4\}$ . We choose a representative from each orbit, and determine the double cosets to which  $Nt_1t_3t_4t_2t_i$  belongs for each  $i \in \{1, 2, 3, 4\}$ .

- $Nt_1t_3t_4t_2 \cdot t_1 \in [13421]$ . This is a new double coset, which extends our graph from

[1342] to [13421]. Since there is one element in this orbit, there is one  $t_i$  that takes [1342] to [13421].

- $Nt_1t_3t_4t_2 \cdot t_2 = Nt_1t_3t_4 \in [134]$ . This double coset will go back to [134]. Since there is one element in this orbit, there is one  $t_i$  that takes [1342] to [134].
- $Nt_1t_3t_4t_2 \cdot t_3 = Nt_1t_3t_4t_2t_3 = Nt_4t_2t_1t_2 \in [1343]$ . This double coset will go to [1343]. Since there is one element in this orbit, there is one  $t_i$  that takes [1342] to [1343].
- $Nt_1t_3t_4t_2 \cdot t_4 = Nt_1t_3t_4t_2t_4 = Nt_3t_1t_4t_2t_4t_2 = Nt_2t_1t_2t_4t_2 \in [12131]$ . This double coset will go to [12131]. Since there is one element in this orbit, there is one  $t_i$  that takes [1342] to [12131].

(vii) We are at a new double coset [1343],  $Nt_1t_3t_4t_3N = \{N(t_1t_3t_4t_3)^n | n \in N\}$ . Now, to determine all the single cosets of this double cosets, we need to determine the point stabilizer  $N^{1343}$ , this means finding the set of elements that fix 1, 3, 4, and 3 in  $N$  and permute the rest of the elements in the set  $\{1, 2, 3, 4\}$ .

**Note:**  $N^{(1343)} = \{n \in N | (t_1t_3t_4t_3)^n = t_1t_3t_4t_3\} \geq \langle e \rangle$ .

Since  $|N^{(1343)}| = 1$  then the number of single cosets in [1343] is  $\frac{|N|}{|N^{(1343)}|} = \frac{4}{1} = 4$ .

Now, the orbits of  $N^{(1343)}$  on  $\{1, 2, 3, 4\}$  are  $\{1\}$ ,  $\{2\}$ ,  $\{3\}$ , and  $\{4\}$ . We choose a representative from each orbit, and determine the double cosets to which  $Nt_1t_3t_4t_3t_i$  belongs for each  $i \in \{1, 2, 3, 4\}$ .

- $Nt_1t_3t_4t_3 \cdot t_1 \in [13431]$ . This is a new double coset, which extends our graph from [1343] to [13431]. Since there is one element in this orbit, there is one  $t_i$  that takes [1343] to [13431].
- $Nt_1t_3t_4t_3 \cdot t_2 = Nt_1t_3t_4t_3t_2 = Nt_4t_2t_1t_3 \in [1342]$ . This double coset will go to [1342]. Since there is one element in this orbit, there is one  $t_i$  that takes [1343] to [1342].
- $Nt_1t_3t_4t_3 \cdot t_3 \in [134]$ . This double coset will go back to [134]. Since there is one element in this orbit, there is one  $t_i$ s that takes [1343] to [134].
- $Nt_1t_3t_4t_3 \cdot t_4 \in [13434]$ . This is a new double coset, which extends our graph from [1343] to [13434]. Since there is one element in this orbit, there is one  $t_i$ s that takes [1343] to [13434].

**Word of Length five** [12124], [12131], [12134], [12431], [12434], [13121], [13421], [13431], and [13434]:

(i) We are at a new double coset [12124],  $Nt_1t_2t_1t_2t_4N = \{N(t_1t_2t_1t_2t_4)^n | n \in N\}$ . Now, to determine all the single cosets of this double cosets, we need to determine the point stabilizer  $N^{12124} = e$ , this means finding the set of elements that fix 1, 3, 1, and 2 in  $N$ . The group stabilizer,  $N^{(12124)}$ . Now, using our relations;

$$\begin{aligned} \Rightarrow N(t_1t_2t_1t_2t_4)^{(1,4)(2,3)} &= Nt_4t_3t_4t_3t_1 = Nt_1t_2t_1t_2t_1t_4 = Nt_1t_2t_1t_2t_4 \\ \Rightarrow (1,4)(2,3) \in N^{(12124)}, &\Rightarrow N^{(12124)} \geq \langle (1,4)(2,3) \rangle. \text{ Thus, } |N^{(12124)}| = 2. \end{aligned}$$

Since  $|N^{(12124)}| = 2$  then the number of single cosets in [12124] is  $\frac{|N|}{|N^{(12124)}|} = \frac{4}{2} = 2$ .

Now, the orbits of  $N^{(12124)}$  on  $\{1, 2, 3, 4\}$  are  $\{1, 4\}$ , and  $\{2, 3\}$ . We choose a representative from each orbit call, and determine the double cosets to which  $Nt_1t_2t_1t_2t_4t_i$  belongs for each  $i \in \{2, 4\}$ .

- $Nt_1t_2t_1t_2t_4 \cdot t_4 \in [1212]$ . This double coset will go to [1212]. Since there are two elements in this orbit, there are two  $t_i$ s that take [12124] to [1212].
- $Nt_1t_2t_1t_2t_4 \cdot t_2 = Nt_1t_2t_1t_2t_4t_2 = Nt_4t_3t_1t_4t_2t_4t_2 = Nt_2t_1t_3t_4t_2t_4 \in [124313]$ . This double coset will go to [124313]. Since there are two elements in this orbit, there are two  $t_i$ s that take [12124] to [124313].

(ii) We are at a new double coset [12131],  $Nt_1t_2t_1t_3t_1N = \{N(t_1t_2t_1t_3t_1)^n | n \in N\}$ . Now, to determine all the single cosets of this double cosets, we need to determine the point stabilizer  $N^{12131}$ , this means finding the set of elements that fix 1, 2, 1, 3, and 1 in  $N$  and permute the rest of the elements in the set  $\{1, 2, 3, 4\}$ . **Note:**  $N^{(12131)} = \{n \in N | (t_1t_2t_1t_3t_1)^n = t_1t_2t_1t_3t_1\} \geq \langle e \rangle$ .

Since  $|N^{(12131)}| = 1$  then the number of single cosets in [12131] is  $\frac{|N|}{|N^{(12131)}|} = \frac{4}{1} = 4$ .

Now, the orbits of  $N^{(12131)}$  on  $\{1, 2, 3, 4\}$  are  $\{1\}$ ,  $\{2\}$ ,  $\{3\}$ , and  $\{4\}$ . We choose a representative from each orbit, and determine the double cosets to which  $Nt_1t_2t_1t_3t_1t_i$  belongs for each  $i \in \{1, 2, 3, 4\}$ .

- $Nt_1t_2t_1t_3t_1 \cdot t_1 \in [1213]$ . This double coset will go back to [1213]. Since there is one element in this orbit, there is one  $t_i$  that takes [12131] to [1213].
- $Nt_1t_2t_1t_3t_1 \cdot t_2 = Nt_1t_2t_1t_3t_1t_2 = Nt_4t_3t_4t_2t_4t_2t_3 = Nt_2t_1t_4t_2t_4t_3 = Nt_3t_1t_2t_4t_3 \in [13421]$ . This double coset will go to [13421]. Since there is one element in this orbit, there is one  $t_i$  that takes [12131] to [13421].

- $Nt_1t_2t_1t_3t_1 \cdot t_3 = Nt_1t_2t_1t_3t_1t_3 = Nt_3t_4t_1t_3t_1 = Nt_2t_4t_3t_1 \in [1342]$ . This double coset will go back to [1342]. Since there is one element in this orbit, there is one  $t_i$  that takes [12131] to [1342].
- $Nt_1t_2t_1t_3t_1 \cdot t_4 = Nt_1t_2t_1t_3t_1t_4 = Nt_4t_3t_4t_2t_1 \in [12134]$ . This double coset will go to [12134]. Since there is one element in this orbit, there is one  $t_i$  that takes [12131] to [12134].

(iii) We are at a new double coset [12134],  $Nt_1t_2t_1t_3t_4N = \{N(t_1t_2t_1t_3t_4)^n | n \in N\}$ . Now, to determine all the single cosets of this double cosets, we need to determine the point stabilizer  $N^{12134} = e$ , this means finding the set of elements that fix 1, 2, 1, 3, and 4 in  $N$ . The coset stabilizers of the coset  $Nt_1t_2t_1t_3t_4$ ,  $N^{(12134)}$ . **Note:**  $N^{(12134)} = \{n \in N | (t_1t_2t_1t_3t_4)^n = t_1t_2t_1t_3t_4\} \geq \langle e \rangle$ .

Since  $|N^{(12134)}| = 1$  then the number of single cosets in [12134] is  $\frac{|N|}{|N^{(12134)}|} = \frac{4}{1} = 4$ .

Now, the orbits of  $N^{(12134)}$  on  $\{1, 2, 3, 4\}$  are  $\{1\}$ ,  $\{2\}$ ,  $\{3\}$ , and  $\{4\}$ . We choose a representative from each orbit, and determine the double cosets to which  $Nt_1t_2t_1t_3t_4t_i$  belongs for each  $i \in \{1, 2, 3, 4\}$ .

- $Nt_1t_2t_1t_3t_4 \cdot t_1 = Nt_1t_2t_1t_3t_4t_1 = Nt_4t_3t_4t_2t_4 \in [12131]$ . This double coset will go to [12131]. Since there is one element in this orbit, there is one  $t_i$  that takes [12134] to [12131].
- $Nt_1t_2t_1t_3t_4 \cdot t_2 \in [121342]$ . This is a new double coset, which extends our graph from [12134] to [121342]. Since there is one element in this orbit, there is one  $t_i$  that takes [12134] to [121342].
- $Nt_1t_2t_1t_3t_4 \cdot t_3 \in [121343]$ . This is a new double coset, which extends our graph from [12134] to [121343]. Since there is one element in this orbit, there is one  $t_i$  that takes [12134] to [121343].
- $Nt_1t_2t_1t_3t_4 \cdot t_4 \in [1213]$ . This double coset will go back to [1213]. Since there is one element in this orbit, there is one  $t_i$  that takes [12134] to [1213].

(iv) We are at a new double coset [12431],  $Nt_1t_2t_4t_3t_1N = \{N(t_1t_2t_4t_3t_1)^n | n \in N\}$ . Now, to determine all the single cosets of this double cosets, we need to determine the point stabilizer  $N^{12431}$ , this means finding the set of elements that fix 1, 2, 4, 3, and



1 in  $N$  and permute the rest of the elements in the set  $\{1, 2, 3, 4\}$ . **Note:**  $N^{(12431)} = \{n \in N | (t_1 t_2 t_4 t_3 t_1)^n = t_1 t_2 t_4 t_3 t_1\} \geq \langle e \rangle$ .

Since  $|N^{(12431)}| = 1$  then the number of single cosets in  $[12431]$  is  $\frac{|N|}{|N^{(12431)}|} = \frac{4}{1} = 4$ .

Now, the orbits of  $N^{(12431)}$  on  $\{1, 2, 3, 4\}$  are  $\{1\}$ ,  $\{2\}$ ,  $\{3\}$ , and  $\{4\}$ . We choose a representative from each orbit, and determine the double cosets to which  $Nt_1 t_2 t_4 t_3 t_1 t_i$  belongs for each  $i \in \{1, 2, 3, 4\}$ .

- $Nt_1 t_2 t_4 t_3 t_1 \cdot t_1 \in [1243]$ . This double coset will go back to  $[1243]$ . Since there is one element in this orbit, there is one  $t_i$  that takes  $[12431]$  to  $[1243]$ .
- $Nt_1 t_2 t_4 t_3 t_1 \cdot t_2 \in [124312]$ . This is a new double coset, which extends our graph from  $[12431]$  to  $[124312]$ . Since there is one element in this orbit, there is one  $t_i$  that takes  $[12431]$  to  $[124312]$ .
- $Nt_1 t_2 t_4 t_3 t_1 \cdot t_3 \in [124313]$ . This is a new double coset, which extends our graph from  $[12431]$  to  $[124313]$ . Since there is one element in this orbit, there is one  $t_i$  that takes  $[12431]$  to  $[124313]$ .
- $Nt_1 t_2 t_4 t_3 t_1 \cdot t_4 = Nt_1 t_2 t_4 t_3 t_1 t_4 = Nt_4 t_3 t_1 t_2 t_1 \in [12434]$ . This double coset will go to  $[12434]$ . Since there is one element in this orbit, there is one  $t_i$  that takes  $[12431]$  to  $[12434]$ .

(v) We are at a new double coset  $[12434]$ ,  $Nt_1 t_2 t_4 t_3 t_4 N = \{N(t_1 t_2 t_4 t_3 t_4)^n | n \in N\}$ . Now, to determine all the single cosets of this double cosets, we need to determine the point stabilizer  $N^{12434}$ , this means finding the set of elements that fix 1, 2, 4, 3, and 4 in  $N$  and permute the rest of the elements in the set  $\{1, 2, 3, 4\}$ . **Note:**  $N^{(12434)} = \{n \in N | (t_1 t_2 t_4 t_3 t_4)^n = t_1 t_2 t_4 t_3 t_4\} \geq \langle e \rangle$ .

Since  $|N^{(12434)}| = 1$  then the number of single cosets in  $[12434]$  is  $\frac{|N|}{|N^{(12434)}|} = \frac{4}{1} = 4$ .

Now, the orbits of  $N^{(12434)}$  on  $\{1, 2, 3, 4\}$  are  $\{1\}$ ,  $\{2\}$ ,  $\{3\}$ , and  $\{4\}$ . We choose a representative from each orbit, and determine the double cosets to which  $Nt_1 t_2 t_4 t_3 t_4 t_i$  belongs for each  $i \in \{1, 2, 3, 4\}$ .

- $Nt_1 t_2 t_4 t_3 t_4 \cdot t_1 = Nt_1 t_2 t_4 t_3 t_4 t_1 = Nt_4 t_3 t_1 t_2 t_4 \in [12431]$ . This double coset will go to  $[12431]$ . Since there is one element in this orbit, there is one  $t_i$  that takes  $[12434]$  to  $[12431]$ .

- $Nt_1t_2t_4t_3t_4 \cdot t_2 \in [124342]$ . This is a new double coset, which extends our graph from  $[12434]$  to  $[124342]$ . Since there is one element in this orbit, there is one  $t_i$  that takes  $[12434]$  to  $[124342]$ .
- $Nt_1t_2t_4t_3t_4 \cdot t_3 \in [124343]$ . This is a new double coset, which extends our graph from  $[12434]$  to  $[124343]$ . Since there is one element in this orbit, there is one  $t_i$  that takes  $[12434]$  to  $[124343]$ .
- $Nt_1t_2t_4t_3t_4 \cdot t_4 \in [1243]$ . This double coset will go back to  $[1243]$ . Since there is one element in this orbit, there is one  $t_i$  that takes  $[12434]$  to  $[1243]$ .

(vi) We are at a new double coset  $[13121]$ ,  $Nt_1t_3t_1t_2t_1N = \{N(t_1t_3t_1t_2t_1)^n | n \in N\}$ . Now, to determine all the single cosets of this double cosets, we need to determine the point stabilizer  $N^{13121}$ , this means finding the set of elements that fix 1, 3, 1, 2, and 1 in  $N$  and permute the rest of the elements in the set  $\{1, 2, 3, 4\}$ . **Note:**  $N^{(13121)} = \{n \in N | (t_1t_3t_1t_2t_1)^n = t_1t_3t_1t_2t_1\} \geq \langle e \rangle$ .

Since  $|N^{(13121)}| = 1$  then the number of single cosets in  $[13121]$  is  $\frac{|N|}{|N^{(13121)}|} = \frac{4}{1} = 4$ .

Now, the orbits of  $N^{(13121)}$  on  $\{1, 2, 3, 4\}$  are  $\{1\}$ ,  $\{2\}$ ,  $\{3\}$ , and  $\{4\}$ . We choose a representative from each orbit, and determine the double cosets to which  $Nt_1t_3t_1t_2t_1t_i$  belongs for each  $i \in \{1, 2, 3, 4\}$ .

- $Nt_1t_3t_1t_2t_1 \cdot t_1 \in [1312]$ . This double coset will go back to  $[1312]$ . Since there is one element in this orbit, there is one  $t_i$  that takes  $[13121]$  to  $[1312]$ .
- $Nt_1t_3t_1t_2t_1 \cdot t_2 = Nt_1t_3t_1t_2t_1t_2 = Nt_4t_3t_2t_1t_2t_1t_2 = Nt_3t_4t_2t_1t_2t_1 \in [124343]$ . This double coset will go to  $[124343]$ . Since there is one element in this orbit, there is one  $t_i$  that takes  $[13121]$  to  $[124343]$ .
- $Nt_1t_3t_1t_2t_1 \cdot t_3 = Nt_1t_3t_1t_2t_1t_3 = Nt_4t_2t_4t_2t_3t_1t_3 = Nt_4t_2t_4t_3t_1t_3 = Nt_1t_3t_4t_1t_3t_1t_3 = Nt_3t_1t_2t_1t_3t_1 \in [13431]$ . This double coset will go to  $[13431]$ . Since there is one element in this orbit, there is one  $t_i$  that takes  $[13121]$  to  $[13431]$ .
- $Nt_1t_3t_1t_2t_1 \cdot t_4 = Nt_1t_3t_1t_2t_1t_4 = Nt_4t_2t_4t_3t_1 = Nt_1t_3t_4t_1t_3t_1 = Nt_3t_1t_2t_1t_3t_1t_3 = Nt_2t_4t_2t_3t_1t_3t_1t_3 = Nt_4t_2t_4t_3t_1 \in [13121]$ . This double coset will collapse. Since there is one element in this orbit, there is one  $t_i$  that takes  $[13121]$  to itself.

(vii) We are at a new double coset  $[13421]$ ,  $Nt_1t_3t_4t_2t_1N = \{N(t_1t_3t_4t_2t_1)^n | n \in N\}$ . Now, to determine all the single cosets of this double cosets, we need to determine the point stabilizer  $N^{13421}$ , this means finding the set of elements that fix 1, 3, 4, 2, and 1 in  $N$  and permute the rest of the elements in the set  $\{1, 2, 3, 4\}$ . **Note:**  $N^{(13421)} = \{n \in N | (t_1t_3t_4t_2t_1)^n = t_1t_3t_4t_2t_1\} \geq \langle e \rangle$ .

Since  $|N^{(13421)}| = 1$  then the number of single cosets in  $[13421]$  is  $\frac{|N|}{|N^{(13421)}|} = \frac{4}{1} = 4$ .

Now, the orbits of  $N^{(13421)}$  on  $\{1, 2, 3, 4\}$  are  $\{1\}$ ,  $\{2\}$ ,  $\{3\}$ , and  $\{4\}$ . We choose a representative from each orbit, and determine the double cosets to which  $Nt_1t_3t_4t_2t_1t_i$  belongs for each  $i \in \{1, 2, 3, 4\}$ .

- $Nt_1t_3t_4t_2t_1 \cdot t_1 \in [1342]$ . This double coset will go back to  $[1342]$ . Since there is one element in this orbit, there is one  $t_i$  that takes  $[13421]$  to  $[1342]$ .
- $Nt_1t_3t_4t_2t_1 \cdot t_2 \in [134212]$ . This is a new double coset, which extends our graph from  $[13421]$  to  $[134212]$ . Since there is one element in this orbit, there is one  $t_i$  that takes  $[13421]$  to  $[134212]$ .
- $Nt_1t_3t_4t_2t_1 \cdot t_3 \in [134213]$ . This is a new double coset, which extends our graph from  $[13421]$  to  $[134213]$ . Since there is one element in this orbit, there is one  $t_i$  that takes  $[13421]$  to  $[134213]$ .
- $Nt_1t_3t_4t_2t_1 \cdot t_4 = Nt_1t_3t_4t_2t_1t_4 = Nt_4t_2t_1t_3t_1 = Nt_1t_2t_3t_1t_3t_1 = Nt_3t_4t_3t_1t_3 \in [12131]$ . This double coset will go to  $[12131]$ . Since there is one element in this orbit, there is one  $t_i$  that takes  $[13421]$  to  $[12131]$ .

(viii) We are at a new double coset  $[13431]$ ,  $Nt_1t_3t_4t_3t_1N = \{N(t_1t_3t_4t_3t_1)^n | n \in N\}$ . Now, to determine all the single cosets of this double cosets, we need to determine the point stabilizer  $N^{13431}$ , this means finding the set of elements that fix 1, 3, 4, 3, and 1 in  $N$  and permute the rest of the elements in the set  $\{1, 2, 3, 4\}$ . **Note:**  $N^{(13431)} = \{n \in N | (t_1t_3t_4t_3t_1)^n = t_1t_3t_4t_3t_1\} \geq \langle e \rangle$ .

Since  $|N^{(13431)}| = 1$  then the number of single cosets in  $[13431]$  is  $\frac{|N|}{|N^{(13431)}|} = \frac{4}{1} = 4$ .

Now, the orbits of  $N^{(13431)}$  on  $\{1, 2, 3, 4\}$  are  $\{1\}$ ,  $\{2\}$ ,  $\{3\}$ , and  $\{4\}$ . We choose a representative from each orbit, and determine the double cosets to which  $Nt_1t_3t_4t_3t_1t_i$  belongs for each  $i \in \{1, 2, 3, 4\}$ .

- $Nt_1t_3t_4t_3t_1 \cdot t_1 \in [1343]$ . This double coset will go back to  $[1343]$ . Since there is one element in this orbit, there is one  $t_i$  that takes  $[13431]$  to  $[1343]$ .

- $Nt_1t_3t_4t_3t_1 \cdot t_2 \in [134312]$ . This is a new double coset, which extends our graph from [13431] to [134312]. Since there is one element in this orbit, there is one  $t_i$  that takes [13431] to [134312].
- $Nt_1t_3t_4t_3t_1 \cdot t_3 = Nt_1t_3t_4t_3t_1t_3 = Nt_4t_2t_4t_1t_3t_1t_3 = Nt_4t_2t_4t_2t_1t_3t_1t_3 = Nt_2t_4t_2t_4t_1t_3t_1 = Nt_3t_1t_3t_4t_3t_1 \in [13121]$ . This double coset will go to [13121]. Since there is one element in this orbit, there is one  $t_i$  that takes [13431] to [13121].
- $Nt_1t_3t_4t_3t_1 \cdot t_4 = Nt_1t_3t_4t_3t_1t_4 = Nt_4t_2t_1t_2t_1 \in [13434]$ . This double coset will go to [13434]. Since there is one element in this orbit, there is one  $t_i$  that takes [13431] to [13434].

(viii) We are at a new double coset [13434],  $Nt_1t_3t_4t_3t_4N = \{N(t_1t_3t_4t_3t_4)^n | n \in N\}$ . Now, to determine all the single cosets of this double cosets, we need to determine the point stabilizer  $N^{13434} = e$ , this means finding the set of the elements that fix 1, 3, 4, 3, and 4 in  $N$ . The coset stabilizers of the coset  $Nt_1t_3t_4t_3t_4$ ,  $N^{(13434)}$ . Now, using our relations;

$$\Rightarrow N(t_1t_3t_4t_3t_4)^{(1,2)(3,4)} = Nt_2t_4t_3t_4t_3$$

$$= Nt_2t_3t_4t_3t_4t_3 = Nt_1t_3t_4t_3t_4 \Rightarrow (1, 2)(3, 4) \in N^{(13434)},$$

$\Rightarrow N^{(13434)} \geq \langle (1, 2)(3, 4) \rangle$ . Thus,  $|N^{(13434)}| = 2$ . Since  $|N^{(13434)}| = 2$  then the number of single cosets in [13434] is  $\frac{|N|}{|N^{(13434)}|} = \frac{4}{2} = 2$ .

Now, the orbits of  $N^{(13434)}$  on  $\{1, 2, 3, 4\}$  are  $\{1, 2\}$ , and  $\{3, 4\}$ . We choose a representative from each orbit call,  $\{1\}$ , and determine the double cosets to which  $Nt_1t_3t_4t_3t_4t_i$  belongs for each  $i \in \{1, 4\}$ .

- $Nt_1t_3t_4t_3t_4 \cdot t_1 = Nt_1t_3t_4t_3t_4t_1 = Nt_4t_2t_1t_2t_4 \in [13431]$ . This double coset will sent to [13431]. Since there are two elements in this orbits, there are two  $t_i$ s that take [13434] to [13431].
- $Nt_1t_3t_4t_3t_4 \cdot t_4 \in [1343]$ . This double coset will back to [1343]. Since there are two elements in this orbit, there are two  $t_i$ s that take [13434] to [1343].

**Word of Length Six** [121342], [121343], [124312], [124313],[124342],[124343] , [134212], [134213], and [134312]:

(i) We are at a new double coset [121342],  $Nt_1t_2t_1t_3t_4t_2N = \{N(t_1t_2t_1t_3t_4t_2)^n | n \in N\}$ . Now, to determine all the single cosets of this double cosets, we need to determine the

point stabilizer  $N^{121342} = e$ , this means finding the set of elements that fix 1, 2, 1, 3, 4, and 2 in  $N$ . The group stabilizer,  $N^{(121342)}$ . Now, using our relations;

$$\Rightarrow N(t_1 t_2 t_1 t_3 t_4 t_2)^{(1,3)(2,4)} = N t_3 t_4 t_3 t_1 t_2 t_4 = N t_1 t_2 t_1 t_3 t_4 t_2 \Rightarrow (1, 3)(2, 4) \in N^{(121342)},$$

$\Rightarrow N^{(121342)} \geq \langle (1, 3)(2, 4) \rangle$ . Thus,  $|N^{(121342)}| = 2$ . Since  $|N^{(121342)}| = 2$  then the number of single cosets in  $[12124]$  is  $\frac{|N|}{|N^{(121342)}|} = \frac{4}{2} = 2$ .

Now, the orbits of  $N^{(121342)}$  on  $\{1, 2, 3, 4\}$  are  $\{1, 3\}$ , and  $\{2, 4\}$ . We choose a representative from each orbit, and determine the double cosets to which  $N t_1 t_2 t_1 t_3 t_4 t_2 t_i$  belongs for each  $i \in \{2, 3\}$ .

- $N t_1 t_2 t_1 t_3 t_4 t_2 \cdot t_2 \in [12134]$ . This double coset will go to  $[12134]$ . Since there are two elements in this orbit, there are two  $t_i$ s that take  $[121342]$  to  $[12134]$ .
- $N t_1 t_2 t_1 t_3 t_4 t_2 \cdot t_3 = N t_1 t_2 t_1 t_3 t_4 t_2 t_3 = N t_4 t_3 t_4 t_2 t_1 t_2 = N t_1 t_2 t_4 t_1 t_2 t_1 t_2 = N t_2 t_1 t_3 t_1 t_2 t_1 t_2 t_1 = N t_3 t_4 t_3 t_2 t_1 t_2 t_1 t_2 t_1 = N t_4 t_3 t_4 t_2 t_1 t_2 \in [121343]$ . This double coset will go to  $[121343]$ . Since there are two elements in this orbit, there are two  $t_i$ s that take  $[121342]$  to  $[121343]$ .

(ii) We are at a new double coset  $[121343]$ ,  $N t_1 t_2 t_1 t_3 t_4 t_3 N = \{N(t_1 t_2 t_1 t_3 t_4 t_3)^n | n \in N\}$ . Now, to determine all the single cosets of this double cosets, we need to determine the point stabilizer  $N^{121343}$ , this means finding the set of elements that fix 1, 2, 1, 3, 4, and 3 in  $N$  and permute the rest of the elements in the set  $\{1, 2, 3, 4\}$ . **Note:**  $N^{(121343)} = \{n \in N | (t_1 t_2 t_1 t_3 t_4 t_3)^n = t_1 t_2 t_1 t_3 t_4 t_3\} \geq \langle e \rangle$ .

Since  $|N^{(121343)}| = 1$  then the number of single cosets in  $[121343]$  is  $\frac{|N|}{|N^{(121343)}|} = \frac{4}{1} = 4$ .

Now, the orbits of  $N^{(121343)}$  on  $\{1, 2, 3, 4\}$  are  $\{1\}$ ,  $\{2\}$ ,  $\{3\}$ , and  $\{4\}$ . We choose a representative from each orbit, and determine the double cosets to which  $N t_1 t_2 t_1 t_3 t_4 t_3 t_i$  belongs for each  $i \in \{1, 2, 3, 4\}$ .

- $N t_1 t_2 t_1 t_3 t_4 t_3 \cdot t_1 \in [1243124]$ . This will go to  $[1243124]$ . Since there is one element in this orbit, there is one  $t_i$  that takes  $[121343]$  to  $[1243124]$ .
- $N t_1 t_2 t_1 t_3 t_4 t_3 \cdot t_2 = N t_1 t_2 t_1 t_3 t_4 t_3 t_2 = N t_4 t_3 t_4 t_2 t_1 t_3 \in [121342]$ . This double coset will go to  $[121342]$ . Since there is one element in this orbit, there is one  $t_i$  that takes  $[121343]$  to  $[121342]$ .
- $N t_1 t_2 t_1 t_3 t_4 t_3 \cdot t_3 = N t_1 t_2 t_1 t_3 t_4 \in [12134]$ . This double coset will go back to  $[12134]$ . Since there is one element in this orbit, there is one  $t_i$  that takes  $[121343]$  to  $[12134]$ .

- $Nt_1t_2t_1t_3t_4t_3 \cdot t_4 \in [124312]$ . This double coset will go to  $[124312]$ . Since there is one element in this orbit, there is one  $t_i$  that takes  $[121343]$  to  $[124312]$ .

(iii) We are at a new double coset  $[124312]$ ,  $Nt_1t_2t_4t_3t_1t_2N = \{N(t_1t_2t_4t_3t_1t_2)^n | n \in N\}$ . Now, to determine all the single cosets of this double cosets, we need to determine the point stabilizer  $N^{124312} = e$ , this means finding the set of elements that fix 1, 2, 4, 3, 1, and 2 in  $N$ . **Note:**  $N^{(124312)} = \{n \in N | (t_1t_2t_4t_3t_1t_2)^n = t_1t_2t_4t_3t_1t_2\} \geq \langle e \rangle$ .

Since  $|N^{(124312)}| = 1$  then the number of single cosets in  $[124312]$  is  $\frac{|N|}{|N^{(124312)}|} = \frac{4}{1} = 4$ .

Now, the orbits of  $N^{(124312)}$  on  $\{1, 2, 3, 4\}$  are  $\{1\}$ ,  $\{2\}$ ,  $\{3\}$ , and  $\{4\}$ . We choose a representative from each orbit, and determine the double cosets to which  $Nt_1t_2t_4t_3t_1t_2t_i$  belongs for each  $i \in \{1, 2, 3, 4\}$ .

- $Nt_1t_2t_4t_3t_1t_2 \cdot t_1 = Nt_1t_2t_4t_3t_1t_2t_1 = Nt_4t_3t_1t_3t_2t_1t_2t_1 = Nt_4t_3t_1t_3t_2t_1t_2t_1$   
 $= Nt_3t_4t_2t_4t_2t_1t_2t_1t_2 = Nt_3t_2t_4t_2t_4t_2t_1t_2t_1t_2 = Nt_1t_2t_4t_1t_2t_1t_2 = Nt_4t_3t_4t_2t_1t_2$   
 $\in [121343]$ . This double coset will go back to  $[121343]$ . Since there is one element in this orbit, there is one  $t_i$  that takes  $[124312]$  to  $[121343]$ .
- $Nt_1t_2t_4t_3t_1t_2 \cdot t_2 \in [12431]$ . This double coset will go back to  $[12431]$ . Since there is one element in this orbit, there is one  $t_i$  that takes  $[124312]$  to  $[12431]$ .
- $Nt_1t_2t_4t_3t_1t_2 \cdot t_3 = Nt_1t_2t_4t_3t_1t_2t_3 = Nt_4t_3t_1t_2t_4t_2 \in [124313]$ . This double coset will go back to  $[124313]$ . Since there is one element in this orbit, there is one  $t_i$  that takes  $[124312]$  to  $[124313]$ .
- $Nt_1t_2t_4t_3t_1t_2 \cdot t_4 \in [1243124]$ . This is a new double coset, which extends our graph from  $[124312]$  to  $[1243124]$ . Since there is one element in this orbit, there is one  $t_i$  that takes  $[124312]$  to  $[1243124]$ .

(iv) We are at a new double coset  $[124313]$ ,  $Nt_1t_2t_4t_3t_1t_3N = \{N(t_1t_2t_4t_3t_1t_3)^n | n \in N\}$ . Now, to determine all the single cosets of this double cosets, we need to determine the point stabilizer  $N^{124313}$ , this means finding the set of elements that fix 1, 2, 4, 3, 1, and 3 in  $N$  and permute the rest of the elements in the set  $\{1, 2, 3, 4\}$ . **Note:**  $N^{(124313)} = \{n \in N | (t_1t_2t_4t_3t_1t_3)^n = t_1t_2t_4t_3t_1t_3\} \geq \langle e \rangle$ .

Since  $|N^{(124313)}| = 1$  then the number of single cosets in  $[124313]$  is  $\frac{|N|}{|N^{(124313)}|} = \frac{4}{1} = 4$ .

Now, the orbits of  $N^{(124313)}$  on  $\{1, 2, 3, 4\}$  are  $\{1\}$ ,  $\{2\}$ ,  $\{3\}$ , and  $\{4\}$ . We choose a

representative from each orbit, and determine the double cosets to which  $Nt_1t_2t_4t_3t_1t_3t_i$  belongs for each  $i \in \{1, 2, 3, 4\}$ .

- $Nt_1t_2t_4t_3t_1t_3 \cdot t_1 = Nt_1t_2t_4t_3t_1t_3t_1 = Nt_4t_3t_4t_1t_3t_1t_3t_1 = Nt_4t_3t_4t_1t_3t_1t_3t_1$   
 $= Nt_2t_1t_2t_1t_3 = Nt_3t_4t_3t_4t_3t_2 = Nt_3t_4t_3t_4t_2 \in [12124]$ . This double coset will go to  $[12124]$ . Since there is one element in this orbit, there is one  $t_i$  that takes  $[124313]$  to  $[12124]$ .
- $Nt_1t_2t_4t_3t_1t_3 \cdot t_2 = Nt_1t_2t_4t_3t_1t_3t_2 = Nt_4t_3t_1t_2t_4t_3 \in [124312]$ . This double coset will go to  $[124312]$ . Since there is one element in this orbit, there is one  $t_i$  that takes  $[124313]$  to  $[124312]$ .
- $Nt_1t_2t_4t_3t_1t_3 \cdot t_3 \in [12431]$ . This double coset will go back to  $[12431]$ . Since there is one element in this orbit, there is one  $t_i$  that takes  $[124313]$  to  $[12431]$ .
- $Nt_1t_2t_4t_3t_1t_3 \cdot t_4 = Nt_1t_2t_4t_3t_1t_3t_4 = Nt_4t_3t_1t_2t_4t_2t_4t_1$   
 $= Nt_1t_2t_1t_4t_2t_4t_2t_4t_1 = Nt_1t_2t_1t_4t_2t_4t_2t_4t_1 = Nt_3t_4t_3t_4t_2t_1 = Nt_3t_4t_3t_4t_2t_1$   
 $= Nt_3t_4t_3t_4t_3t_2t_1 = Nt_2t_1t_2t_1t_3t_1 = Nt_3t_4t_2t_3t_1t_3t_1 = Nt_1t_2t_4t_3t_1t_3 \in [124313]$ .  
 This double coset will collapse. Since there is one element in this orbit, there is one  $t_i$  that takes  $[124313]$  to itself.

(v) We are at a new double coset  $[124342]$ ,  $Nt_1t_2t_4t_3t_4t_2N = \{N(t_1t_2t_4t_3t_4t_2)^n | n \in N\}$ . Now, to determine all the single cosets of this double cosets, we need to determine the point stabilizer  $N^{124342}$ , this means finding the set of elements that fix 1, 2, 4, 3, 4, and 2 in  $N$  and permute the rest of the elements in the set  $\{1, 2, 3, 4\}$ . **Note:**  $N^{(124342)} = \{n \in N | (t_1t_2t_4t_3t_4t_2)^n = t_1t_2t_4t_3t_4t_2\} \geq \langle e \rangle$ .

Since  $|N^{(124342)}| = 1$  then the number of single cosets in  $[124342]$  is  $\frac{|N|}{|N^{(124342)}|} = \frac{4}{1} = 4$ .

Now, the orbits of  $N^{(124342)}$  on  $\{1, 2, 3, 4\}$  are  $\{1\}$ ,  $\{2\}$ ,  $\{3\}$ , and  $\{4\}$ . We choose a representative from each orbit, and determine the double cosets to which  $Nt_1t_2t_4t_3t_4t_2t_i$  belongs for each  $i \in \{1, 2, 3, 4\}$ .

- $Nt_1t_2t_4t_3t_4t_2 \cdot t_1 \in [1243421]$ . This is a new double coset, which extends our graph from  $[124342]$  to  $[1243421]$ . Since there is one element in this orbit, there is one  $t_i$  that takes  $[124342]$  to  $[1243421]$ .
- $Nt_1t_2t_4t_3t_4t_2 \cdot t_2 \in [12434]$ . This double coset will go back to  $[12434]$ . Since there is one element in this orbit, there is one  $t_i$  that takes  $[124342]$  to  $[12434]$ .

- $Nt_1t_2t_4t_3t_4t_2 \cdot t_3 = Nt_1t_2t_4t_3t_4t_2t_3 = Nt_4t_3t_1t_2t_1t_2 \in [124343]$ . This double coset will go to  $[124343]$ . Since there is one element in this orbit, there is one  $t_i$  that takes  $[124342]$  to  $[124343]$ .
- $Nt_1t_2t_4t_3t_4t_2 \cdot t_4 \in [124343]$ . This double coset will go back to  $[124343]$ . Since there is one element in this orbit, there is one  $t_i$  that takes  $[124342]$  to  $[124343]$ .

(vi) We are at a new double coset  $[124343]$ ,  $Nt_1t_2t_4t_3t_4t_3N = \{N(t_1t_2t_4t_3t_4t_3)^n | n \in N\}$ . Now, to determine all the single cosets of this double cosets, we need to determine the point stabilizer  $N^{124343}$ , this means finding the set of elements that fix 1, 2, 4, 3, 4, and 3 in  $N$  and permute the rest of the elements in the set  $\{1, 2, 3, 4\}$ . **Note:**  $N^{(124343)} = \{n \in N | (t_1t_2t_4t_3t_4t_3)^n = t_1t_2t_4t_3t_4t_3\} \geq \langle e \rangle$ .

Since  $|N^{(124343)}| = 1$  then the number of single cosets in  $[124343]$  is  $\frac{|N|}{|N^{(124343)}|} = \frac{4}{1} = 4$ .

Now, the orbits of  $N^{(124343)}$  on  $\{1, 2, 3, 4\}$  are  $\{1\}$ ,  $\{2\}$ ,  $\{3\}$ , and  $\{4\}$ . We choose a representative from each orbit, and determine the double cosets to which  $Nt_1t_2t_4t_3t_4t_3t_i$  belongs for each  $i \in \{1, 2, 3, 4\}$ .

- $Nt_1t_2t_4t_3t_4t_3 \cdot t_1 \in [1243431]$ . This is a new double coset, which extends our graph from  $[124343]$  to  $[1243431]$ . Since there is one element in this orbit, there is one  $t_i$  that takes  $[124343]$  to  $[1243431]$ .
- $Nt_1t_2t_4t_3t_4t_3 \cdot t_2 = Nt_1t_2t_4t_3t_4t_3t_2 = Nt_4t_3t_1t_2t_1t_3 \in [124342]$ . This double coset will go to  $[124342]$ . Since there is one element in this orbit, there is one  $t_i$  that takes  $[124343]$  to  $[124342]$ .
- $Nt_1t_2t_4t_3t_4t_3 \cdot t_3 \in [12434]$ . This double coset will go back to  $[12434]$ . Since there is one element in this orbit, there is one  $t_i$  that takes  $[124343]$  to  $[12434]$ .
- $Nt_1t_2t_4t_3t_4t_3 \cdot t_4 = Nt_1t_2t_4t_3t_4t_3t_4 = Nt_4t_2t_3t_4t_3t_4t_3t_4 = Nt_3t_1t_3t_4t_3$   
 $= Nt_2t_4t_2t_4t_1t_3 = Nt_2t_4t_2t_1t_3 \in [13121]$ . This double coset will go back to  $[13121]$ . Since there is one element in this orbit, there is one  $t_i$  that takes  $[124343]$  to  $[13121]$ .

(vii) We are at a new double coset  $[134212]$ ,  $Nt_1t_3t_4t_2t_1t_2N = \{N(t_1t_3t_4t_2t_1t_2)^n | n \in N\}$ . Now, to determine all the single cosets of this double cosets, we need to determine the point stabilizer  $N^{134212}$ , this means finding the set of elements that fix 1, 3, 4, 2, 1, and 2 in  $N$  and permute the rest of the elements in the set  $\{1, 2, 3, 4\}$ .



$\Rightarrow N(t_1t_3t_4t_2t_1t_2)^{(1,2)(3,4)} = Nt_2t_4t_3t_1t_2t_1 = t_1t_3t_4t_2t_1t_2 \Rightarrow (1,2)(3,4) \in N^{(134212)},$   
 $\Rightarrow N^{(134212)} \geq \langle (1,2)(3,4) \rangle$ . Thus,  $|N^{(134212)}| = 2$ . Since  $|N^{(134212)}| = 2$  then the number of single cosets in  $[12124]$  is  $\frac{|N|}{|N^{(134212)}|} = \frac{4}{2} = 2$ .  
 Now, the orbits of  $N^{(134212)}$  on  $\{1, 2, 3, 4\}$  are  $\{1, 2\}$ , and  $\{3, 4\}$ . We choose a representative from each orbit, and determine the double cosets to which  $Nt_1t_3t_4t_2t_1t_2t_i$  belongs for each  $i \in \{2, 3\}$ .

- $Nt_1t_3t_4t_2t_1t_2 \cdot t_2 \in [13421]$ . This double coset will go back to  $[13421]$ . Since there are two elements in this orbit, there is two  $t_i$ s that take  $[134212]$  to  $[13421]$ .
- $Nt_1t_3t_4t_2t_1t_2 \cdot t_3 = Nt_1t_3t_4t_2t_1t_2t_3 = Nt_4t_2t_1t_3t_4t_2 \in [134213]$ . This double coset go to  $[134213]$ . Since there are two elements in this orbit, there is two  $t_i$ s that take  $[134212]$  to  $[134213]$ .

(viii) We are at a new double coset  $[134213]$ ,  $Nt_1t_3t_4t_2t_1t_3N = \{N(t_1t_3t_4t_2t_1t_3)^n | n \in N\}$ . Now, to determine all the single cosets of this double cosets, we need to determine the point stabilizer  $N^{134213}$ , this means finding the set of elements that fix 1, 3, 4, 2, 1, and 3 in  $N$  and permute the rest of the elements in the set  $\{1, 2, 3, 4\}$ . **Note:**  $N^{(134213)} = \{n \in N | (t_1t_3t_4t_2t_1t_3)^n = t_1t_3t_4t_2t_1t_3\} \geq \langle e \rangle$ .

Since  $|N^{(134213)}| = 1$  then the number of single cosets in  $[134213]$  is  $\frac{|N|}{|N^{(134213)}|} = \frac{4}{1} = 4$ .  
 Now, the orbits of  $N^{(134213)}$  on  $\{1, 2, 3, 4\}$  are  $\{1\}$ ,  $\{2\}$ ,  $\{3\}$ , and  $\{4\}$ . We choose a representative from each orbit, and determine the double cosets to which  $Nt_1t_3t_4t_2t_1t_3t_i$  belongs for each  $i \in \{1, 2, 3, 4\}$ .

- $Nt_1t_3t_4t_2t_1t_3 \cdot t_1 = Nt_1t_3t_4t_2t_1t_3t_1 = Nt_4t_2t_1t_2t_3t_1t_3t_1 = Nt_2t_4t_3t_4t_3t_1t_3$   
 $= Nt_3t_1t_2t_1t_2t_1t_4t_3 = Nt_3t_2t_1t_2t_1t_2t_1t_4t_3 = Nt_4t_2t_1t_2t_4t_3 \in [134312]$ . This double coset will go to  $[134312]$ . Since there is one element in this orbit, there is one  $t_i$  that takes  $[134213]$  to  $[134312]$ .
- $Nt_1t_3t_4t_2t_1t_3 \cdot t_2 = Nt_1t_3t_4t_2t_1t_3t_2 = Nt_4t_2t_1t_3t_4t_3 \in [134212]$ . This double coset will go to  $[134212]$ . Since there is one element in this orbit, there is one  $t_i$  that takes  $[134213]$  to  $[134212]$ .
- $Nt_1t_3t_4t_2t_1t_3 \cdot t_3 \in [13421]$ . This double coset will go back to  $[13421]$ . Since there is one element in this orbit, there is one  $t_i$  that takes  $[134213]$  to  $[13421]$ .

- $Nt_1t_3t_4t_2t_1t_3 \cdot t_4 \in [1243124]$ . This double coset will go to  $[1243124]$ . Since there is one element in this orbit, there is one  $t_i$  that takes  $[134213]$  to  $[1243124]$ .

(viii) We are at a new double coset  $[134312]$ ,  $Nt_1t_3t_4t_3t_1t_2N = \{N(t_1t_3t_4t_3t_1t_2)^n | n \in N\}$ . Now, to determine all the single cosets of this double cosets, we need to determine the point stabilizer  $N^{134312}$ , this means finding the set of elements that fix 1, 3, 4, 3, 1, and 2 in  $N$  and permute the rest of the elements in the set  $\{1, 2, 3, 4\}$ . **Note:**  $N^{(134312)} = \{n \in N | (t_1t_3t_4t_3t_1t_2)^n = t_1t_3t_4t_3t_1t_2\} \geq \langle e \rangle$ .

Since  $|N^{(134312)}| = 1$  then the number of single cosets in  $[134312]$  is  $\frac{|N|}{|N^{(134312)}|} = \frac{4}{1} = 4$ .

Now, the orbits of  $N^{(134312)}$  on  $\{1, 2, 3, 4\}$  are  $\{1\}$ ,  $\{2\}$ ,  $\{3\}$ , and  $\{4\}$ . We choose a representative from each orbit, and determine the double cosets to which  $Nt_1t_3t_4t_3t_1t_2t_i$  belongs for each  $i \in \{1, 2, 3, 4\}$ .

- $Nt_1t_3t_4t_3t_1t_2 \cdot t_1 \in [1243124]$ . This double coset will go to  $[134213]$ . Since there is one element in this orbit, there is one  $t_i$  that takes  $[134312]$  to  $[1243124]$ .
- $Nt_1t_3t_4t_3t_1t_2 \cdot t_2 \in [13431]$ . This double coset will go back to  $[13431]$ . Since there is one element in this orbit, there is one  $t_i$  that takes  $[134312]$  to  $[13431]$ .
- $Nt_1t_3t_4t_3t_1t_2 \cdot t_3 \in [1243431]$ . This double coset will go back to  $[1243431]$ . Since there is one element in this orbit, there is one  $t_i$  that takes  $[134312]$  to  $[1243431]$ .
- $Nt_1t_3t_4t_3t_1t_2 \cdot t_4 \in [134213]$ . This double coset will go to  $[134213]$ . Since there is one element in this orbit, there is one  $t_i$  that takes  $[134312]$  to  $[134213]$ .

**Word of Length seven**  $[1243421]$ ,  $[1243124]$ , and  $[1243431]$ :

(i) We are at a new double coset  $[1243421]$ ,  $Nt_1t_2t_4t_3t_4t_2t_1N = \{N(t_1t_2t_4t_3t_4t_2t_1)^n | n \in N\}$ . Now, to determine all the single cosets of this double cosets, we need to determine the point stabilizer  $N^{1243421}$ , this means finding the set of elements that fix 1, 2, 4, 3, 4, 2, and 1 in  $N$  and permute the rest of the elements in the set  $\{1, 2, 3, 4\}$ . **Note:**  $N^{(1243421)} = \{n \in N | (t_1t_2t_4t_3t_4t_2t_1)^n = t_1t_2t_4t_3t_4t_2t_1\} \geq \langle (1, 2)(3, 4), (1, 3)(2, 4), (1, 4)(2, 3) \rangle$ .

Since  $|N^{(1243421)}| = 4$  then the number of single cosets in  $[1243421]$  is  $\frac{|N|}{|N^{(1243421)}|} = \frac{4}{4} = 1$ .

Now, the orbits of  $N^{(1243421)}$  on  $\{1, 2, 3, 4\}$  are  $\{1, 2, 3, 4\}$ . We choose a representative from the orbit, and determine the double cosets to which  $Nt_1t_2t_4t_3t_4t_2t_1$  which will go back to  $[124342]$ . .

(ii) We are at a new double coset  $[1243124]$ ,  $Nt_1t_2t_4t_3t_1t_2t_4N = \{N(t_1t_2t_4t_3t_1t_2t_4)^n | n \in N\}$ . Now, to determine all the single cosets of this double cosets, we need to determine the point stabilizer  $N^{1243124}$ , this means finding the set of elements that fix 1, 2, 4, 3, 1, 2, and 4 in  $N$  and permute the rest of the elements in the set  $\{1, 2, 3, 4\}$ .

**Note:**  $N^{(1243124)} = \{n \in N | (t_1t_2t_4t_3t_1t_2t_4)^n = t_1t_2t_4t_3t_1t_2t_4\} \geq \langle e \rangle$ .

Since  $|N^{(1243124)}| = 1$  then the number of single cosets in  $[1243124]$  is  $\frac{|N|}{|N^{(1243124)}|} = \frac{4}{1} = 4$ . Now, the orbits of  $N^{(1243124)}$  on  $\{1, 2, 3, 4\}$  are  $\{1\}$ ,  $\{2\}$ ,  $\{3\}$ , and  $\{4\}$ . We choose a representative from each orbit, and determine the double cosets to which  $Nt_1t_2t_4t_3t_1t_2t_4t_i$  belongs for each  $i \in \{1, 2, 3, 4\}$ .

- $Nt_1t_2t_4t_3t_1t_2t_4 \cdot t_1 \in [121343]$ . This double coset will go back to  $[121343]$ . Since there is one element in this orbit, there is one  $t_i$  that takes  $[1243421]$  to  $[121343]$ .
- $Nt_1t_2t_4t_3t_1t_2t_4 \cdot t_2 \in [134312]$ . This double coset will go to  $[134312]$ . Since there is one element in this orbit, there is one  $t_i$  that takes  $[1243421]$  to  $[134312]$ .
- $Nt_1t_2t_4t_3t_1t_2t_4 \cdot t_3 \in [134213]$ . This double coset will go to  $[124343]$ . Since there is one element in this orbit, there is one  $t_i$  that takes  $[1243421]$  to  $[134213]$ .
- $Nt_1t_2t_4t_3t_1t_2t_4 \cdot t_4 \in [124312]$ . This double coset will go back to  $[124312]$ . Since there is one element in this orbit, there is one  $t_i$  that takes  $[1243124]$  to  $[124312]$ .

(iii) We are at a new double coset  $[1243431]$ ,  $Nt_1t_2t_4t_3t_4t_3t_1N = \{N(t_1t_2t_4t_3t_4t_3t_1)^n | n \in N\}$ . Now, to determine all the single cosets of this double cosets, we need to determine the point stabilizer  $N^{1243431}$ , this means finding the set of elements that fix 1, 2, 4, 3, 4, 3, and 1 in  $N$  and permute the rest of the elements in the set  $\{1, 2, 3, 4\}$ .

**Note:**  $N^{(1243431)} = \{n \in N | (t_1t_2t_4t_3t_4t_3t_1)^n = t_1t_2t_4t_3t_4t_3t_1\} \geq \langle e \rangle$ .

Since  $|N^{(1243431)}| = 1$  then the number of single cosets in  $[1243431]$  is  $\frac{|N|}{|N^{(1243431)}|} = \frac{4}{1} = 4$ . Now, the orbits of  $N^{(1243431)}$  on  $\{1, 2, 3, 4\}$  are  $\{1\}$ ,  $\{2\}$ ,  $\{3\}$ , and  $\{4\}$ . We choose a representative from each orbit, and determine the double cosets to which  $Nt_1t_2t_4t_3t_4t_3t_1t_i$  belongs for each  $i \in \{1, 2, 3, 4\}$ .

- $Nt_1t_2t_4t_3t_4t_3t_1 \cdot t_1 \in [124343]$ . This double coset will go back to  $[124343]$ . Since there is one element in this orbit, there is one  $t_i$  that takes  $[1243431]$  to  $[124343]$ .
- $Nt_1t_2t_4t_3t_4t_3t_1 \cdot t_2 \in [13431]$ . This double coset will go to  $[1243431]$ . Since there is one element in this orbit, there is one  $t_i$  that takes  $[1243431]$  to  $[13431]$ .

- $Nt_1t_2t_4t_3t_4t_3t_1 \cdot t_3 \in [13421]$ . This double coset will go to  $[134312]$ . Since there is one element in this orbit, there is one  $t_i$  that takes  $[1243431]$  to  $[134312]$ .
- $Nt_1t_2t_4t_3t_4t_3t_1 \cdot t_4 \in [13121]$ . This double coset will go back to  $[13121]$ . Since there is one element in this orbit, there is one  $t_i$  that takes  $[1243431]$  to  $[13121]$ .

**Conclusion:**

The double coset enumeration gives that

$$\begin{aligned}
|G| \leq & ( |N| + |Nt_1N| + |Nt_1t_2N| + |Nt_1t_3N| + |Nt_1t_2t_4N| + |Nt_1t_2t_1N| + |Nt_1t_3t_4N| + \\
& |Nt_1t_3t_1N| + |Nt_1t_2t_4t_2N| + |Nt_1t_2t_4t_3N| + |Nt_1t_2t_1t_2N| + |Nt_1t_2t_1t_3N| + |Nt_1t_3t_4t_2N| \\
& + |Nt_1t_3t_4t_3N| + |Nt_1t_3t_1t_2N| + |Nt_1t_2t_4t_3t_4N| + |Nt_1t_2t_4t_3t_1N| + |Nt_1t_2t_1t_2t_4N| + \\
& |Nt_1t_2t_1t_3t_4N| + |Nt_1t_2t_1t_3t_1N| + |Nt_1t_3t_4t_2t_1N| + |Nt_1t_3t_4t_3t_4N| + |Nt_1t_3t_4t_3t_1N| + \\
& |Nt_1t_3t_1t_2t_1N| + |Nt_1t_2t_4t_3t_4t_2N| + |Nt_1t_2t_4t_3t_4t_3N| + |Nt_1t_2t_4t_3t_1t_2N| + |Nt_1t_2t_4t_3 \\
& t_1t_3N| + |Nt_1t_2t_1t_3t_4t_2N| + |Nt_1t_2t_1t_3t_4t_3N| + |Nt_1t_3t_4t_2t_1t_2N| + |Nt_1t_3t_4t_2t_1t_3N| + \\
& |Nt_1t_3t_4t_3t_1t_2N| + |Nt_1t_2t_4t_3t_4t_2t_1N| + |Nt_1t_2t_4t_3t_4t_3t_1N| + |Nt_1t_2t_4t_3t_1t_2t_4N| ) \times |N| \\
= & (1 + 4 + 4 + 4 + 4 + 4 + 4 + 4 + 2 + 4 + 4 + 4 + 4 + 4 + 2 + 4 + 4 + 2 + 4 + 4 + 4 + 2 \\
& + 4 + 4 + 4 + 4 + 4 + 4 + 2 + 4 + 2 + 4 + 4 + 1 + 4 + 4) \times 4 = (126 \times 4) = 504. \text{ A Cayley} \\
& \text{diagram of } G \text{ over } L_2(8) \text{ is given below.}
\end{aligned}$$

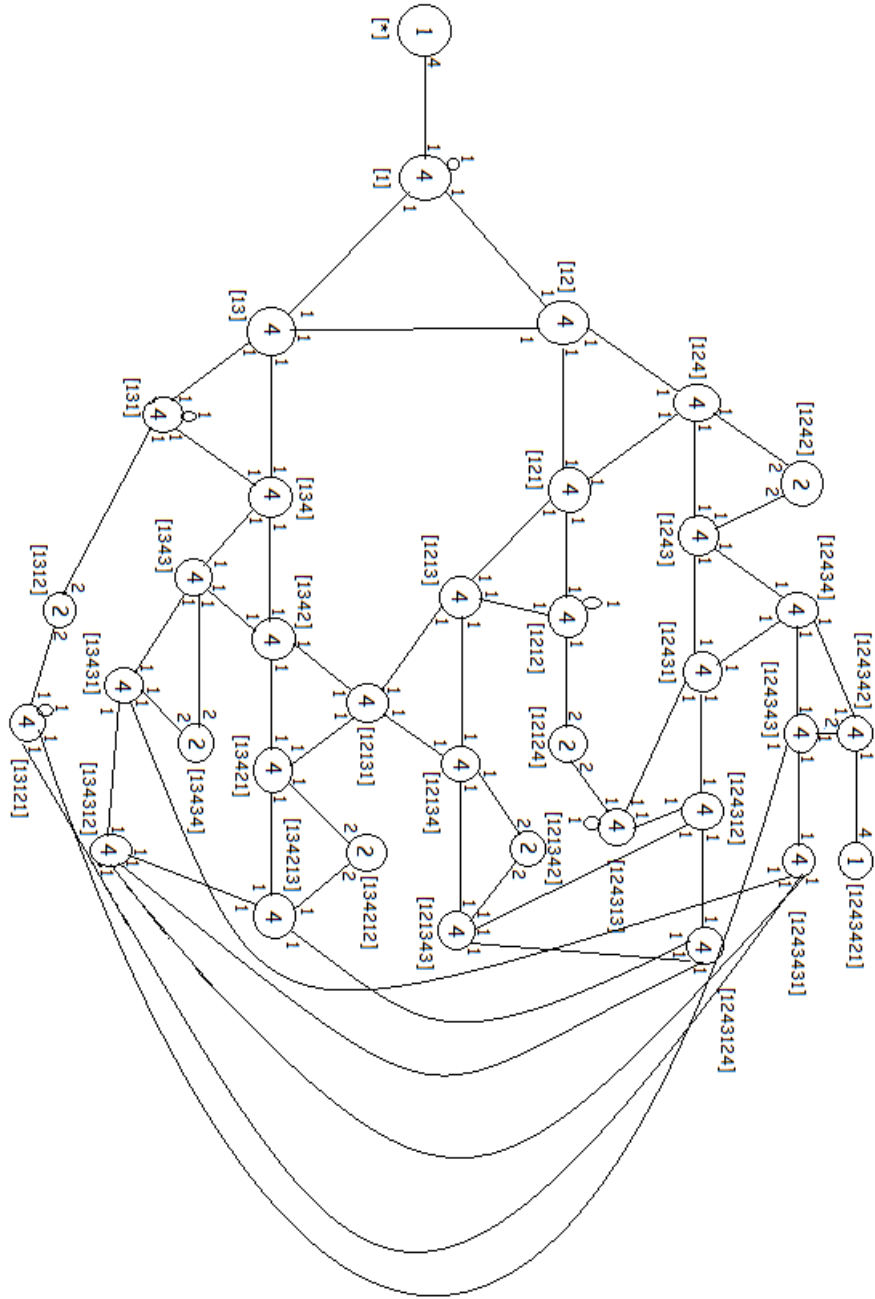

Figure 6.3: Cayley Diagram for  $L_2(8)$  Over  $2^2$

## Chapter 7

# Simple Groups

**Definition 7.1.** If  $X$  is a  $G$ -set, then a **block** is a subset  $B$  of  $X$  such that, for each  $g \in G$ , either  $gB = B$  or  $gB \cap B = \phi$  (of course,  $gB = \{gx : x \in B\}$ ).

**Note:** The blocks  $\phi$ ,  $X$ , and one-point subsets; any other block is called **non-trivial**.

**Definition 7.2.** A transitive  $G$ -set  $X$  is **primitive** if it contains no nontrivial block; otherwise, it is **imprimitive**.

**Theorem 7.3.** Every doubly transitive  $G$ -set  $X$  is primitive.

**Theorem 7.4. (Iwasawa, 1941):**

Let  $G = G'$  (such a group is called **perfect**) and let  $X$  be a faithful primitive  $G$ -set. If there is  $x \in X$  and an abelian normal subgroup  $K \triangleleft G_x$  whose conjugates  $\{gKg^{-1} : g \in G\}$  generate  $G$ , then  $G$  is **simple**.

### 7.1 The Group $L_2(8)$ Over $2^2$

**Example 7.5.** Prove the following group is simple by using its Cayley diagram.

$$G = \frac{2^{*4} : 2^2}{[(xyx)t]^7, [xt]^9, [(xy)t]^3} \cong L_2(8)$$

**Solution:** In order to prove  $G$  is simple, we need to show;

**Step 1:** ( $G$  acts faithfully and primitively)

(i) Suppose we have the  $G$ -set call it  $X$  and we have the subset  $B$  of  $X$ , then to show  $G$  is primitive we will show that  $G$  is transitive and has no nontrivial blocks of  $X$  under the action  $G$ .

By using the Cayley diagram of  $G$ , we have  $X = \{N, Nt_1, Nt_2, Nt_3, Nt_4, \dots, Nt_1t_2t_4t_3t_1t_2t_4, Nt_2t_1t_3t_4t_2t_1t_3N, Nt_3t_4t_2t_1t_3t_4t_2, Nt_4t_3t_1t_2t_4t_3t_1\}$ ; Note:  $|X| = 126$ .

We know  $X$  is a transitive  $G$ -set by using the diagram (since any group  $G$  represented by a Cayley diagram is transitive). Next, we note that if  $B$  is a block of  $X$  under the action of  $G$  then  $|B|$  has to divide  $|X|$ .

So, possible orders of  $B$  are positive divisors of 126.

$$\Rightarrow |B| = 1, 2, 3, 6, 7, 9, 63, 42, 21, 18, 14, 126.$$

We will discard the orders 1 and 126 because those are trivial blocks. Now, a nontrivial block must be of size 2, 3, ... , or 63. Let  $B$  be a nontrivial block and  $N \in B$ . Then if  $Nt_1t_2t_4t_2 \in B$ , we show that  $X$  has a system of blocks of imperatively of size 2.

$X = B \cup Bt_1 \cup Bt_2 \cup \dots \cup Bt_4t_3t_1t_2t_4t_3t_1$  Since  $G$  is transitive, but  $X$  has a nontrivial block, then  $G$  dose not acts primitively.

(ii) We show  $G$  acts faithfully on  $X$ , we know that  $G$  acts on  $X$  implies there exists a homomorphism

$$f : G \rightarrow S_x, \text{ where } (|X| = 126).$$

By First Isomorphic Theorem,  $G/\ker f \cong f(G)$ . So, if  $\ker f = 1$  then  $G \cong f(G)$ . Only elements of  $N$  fix  $N$  that implies  $G_1$  is the point stabilizer of 1 in  $G$ ,  $G_1 = N$ .

$$\Rightarrow |G| = 126 \times |G_1| = 126 \times |N| = 126 \times 36 = 504.$$

$$\Rightarrow |G| = 504.$$

From Cayley Diagram,  $|G| = 504$ .  $G$  will not be faithful on  $X$  if  $\ker f > 1$  and  $|G| > 504$ .

Thus,  $G$  acts faithfully on  $|X|$  since  $\ker f = 1$ .

Thus,  $G$  acts faithfully on  $X$ , but it dose not acts primitively .

**Step 2:  $G$  is perfect ( $G = G'$ )**

Note:  $G = \langle x, y, t \rangle = \langle t_1, t_2, t_3, t_4 \rangle$  and  $2^2 = \langle x, y \rangle = \langle (1, 2)(3, 4), (1, 3)(2, 4) \rangle$ ,  
 $xy = (1, 4)(2, 3)$ . Now  $2^2 \leq G \Rightarrow (2^2)' \leq G'$ .

We know that  $2^{2'} = \langle [x, y] \mid x, y \in 2^2 \rangle$  that implies the following;

- $x = (1, 2)(3, 4), y = (1, 3)(2, 4) \Rightarrow [(1, 2)(3, 4), (1, 3)(2, 4)] = (1, 2)(3, 4)^{-1}(1, 3)(2, 4)^{-1}(1, 2)(3, 4)(1, 3)(2, 4) = e.$
- $x = (1, 2)(3, 4), y = (1, 4)(2, 3) \Rightarrow [(1, 2)(3, 4), (1, 4)(2, 3)] = (1, 2)(3, 4)^{-1}(1, 4)(2, 3)^{-1}(1, 2)(3, 4)(1, 4)(2, 3) = e.$
- $x = (1, 3)(2, 4), y = (1, 4)(2, 3) \Rightarrow [(1, 3)(2, 4), (1, 4)(2, 3)] = (1, 3)(2, 4)^{-1}(1, 4)(2, 3)^{-1}(1, 3)(2, 4)(1, 4)(2, 3) = e.$

Since  $2^2$  is abelian  $(2^2)' = \{e\}$ . We note  $G = \langle t_1, t_2, t_3, t_4 \rangle$  since  $x = t_1 t_2 t_1 t_2 t_1 t_2 t_1$  and  $y = t_1 t_3 t_1 t_3 t_1 t_3 t_1$ . In order to have  $G = G'$ , we will use our relations to prove one of the  $t_i$ 's in  $G'$ .

Let us take this relation  $(1, 4)(3, 2) = t_1 t_4 t_1$   
 $\Rightarrow (1, 4)(3, 2) = t_1 t_4 t_1 \Rightarrow (1, 4)(3, 2)t_4 = t_1 t_4 t_1 t_4 \Rightarrow t_4 t_1 = t_1 t_4 t_1 t_4.$   
 $\Rightarrow t_4 t_1 = [t_1, t_4] \Rightarrow t_4 t_1 \in G' \Rightarrow (t_4 t_1)^{-1} \in G'.$

Let us take the other relations which are  $t_1 t_3 t_1 t_2 t_1 t_3 = (1, 2)(3, 4)t_2 t_1 t_3 t_4 t_3 t_4 t_2$   
and  $t_1 t_3 t_4 t_2 t_1 t_3 t_4 = t_2 t_1 t_3 t_4 t_2 t_1 t_3.$

In the relation  $t_1 t_3 t_1 t_2 t_1 t_3 = (1, 2)(3, 4)t_2 t_1 t_3 t_4 t_3 t_4 t_2$  we replace  $t_2 t_1 t_3 t_4$  by using the relation  $t_1 t_3 t_4 t_2 t_1 t_3 t_4 = t_2 t_1 t_3 t_4 t_2 t_1 t_3 \Rightarrow t_2 t_1 t_3 t_4 = t_1 t_3 t_4 t_2 t_1 t_3 t_4 t_3 t_1 t_2.$

$$\begin{aligned} \Rightarrow t_1 t_3 t_1 t_2 t_1 t_3 &= (1, 2)(3, 4)t_1 t_3 t_4 t_2 t_1 t_3 t_4 t_3 t_1 t_2 t_3 t_4 t_2. \\ \Rightarrow (t_1 t_3 t_1 t_2 t_1 t_3)^{t_3} &= ((1, 2)(3, 4)t_1 t_3 t_4 t_2 t_1 t_3 t_4 t_3 t_1 t_2 t_3 t_4 t_2)^{t_3}. \\ \Rightarrow t_3 t_1 t_3 t_1 t_2 t_1 t_3 t_3 &= (1, 2)(3, 4)t_4 t_1 t_3 t_4 t_2 t_1 t_3 t_4 t_3 t_1 t_2 t_3 t_4 t_2 t_3. \\ \Rightarrow t_3 t_1 t_3 t_1 t_2 t_1 &= (1, 2)(3, 4)t_4 t_1 t_3 t_4 t_2 t_1 t_3 t_4 t_3 t_1 t_2 t_3 t_4 t_2 t_3. \\ \Rightarrow t_3 t_1 t_3 t_1 t_2 t_1 &= (1, 2)(3, 4)\underline{t_4 t_1 t_3 t_4 t_2 t_1 t_3 t_4 t_3 t_1 t_2 t_3 t_4 t_2 t_3}. \\ \Rightarrow t_3 t_1 t_3 t_1 t_2 t_1 &= (1, 3)(2, 4)t_4 t_3 t_4 t_2 t_1 t_3 t_4 t_3 t_1 t_2 t_3 t_4 (1, 4)(2, 3)t_2. \\ \Rightarrow t_3 t_1 t_3 t_1 t_2 t_1 &= (1, 2)(3, 4)t_1 t_2 t_1 t_3 t_4 t_2 t_1 t_2 t_4 t_3 t_2 t_1 t_2. \\ \Rightarrow \underline{t_3 t_1 t_3 t_1} &= (1, 2)(3, 4)t_1 t_2 t_1 t_3 t_4 t_2 t_1 t_2 t_4 t_3 t_2 t_1 t_2 t_1 t_2. \\ \Rightarrow [t_3, t_1] &= (1, 2)(3, 4)t_1 t_2 t_1 t_3 t_4 t_2 t_1 t_2 t_4 t_3 (1, 2)(3, 4)t_2 t_1 t_2 t_1. \\ \Rightarrow [t_3, t_1] &= t_2 t_1 t_2 t_4 t_3 t_1 t_2 t_1 t_3 t_4 t_2 t_1 t_2 t_1. \\ \Rightarrow [t_3, t_1] &= t_2 t_1 t_2 t_4 t_3 t_1 t_2 t_1 t_3 t_4 t_2 t_1 t_2 t_1. \\ \Rightarrow [t_3, t_1] t_1 t_2 t_1 t_2 &= t_2 t_1 t_2 t_4 t_3 t_1 t_2 t_1 t_3 t_4. \\ \Rightarrow [t_3, t_1][t_1, t_2] &= t_2 t_1 t_2 t_4 t_3 t_1 t_2 t_1 t_3 t_4. \\ \Rightarrow [t_3, t_1][t_1, t_2] &= t_2(1, 4)(2, 3)t_4 t_3 t_4 t_1 t_3 t_1 t_2 t_1 t_3 t_4. \end{aligned}$$



$$\begin{aligned}
&\Rightarrow [t_3, t_1][t_1, t_2] = (1, 4)(2, 3)t_3t_4t_3t_4t_1t_3t_1t_2t_1t_3t_4. \\
&\Rightarrow [t_3, t_1][t_1, t_2] = (1, 4)(2, 3)\underline{t_3t_4t_3t_4t_1t_3t_1t_2t_1t_3t_4}. \\
&\Rightarrow [t_3, t_1][t_1, t_2] = (1, 3)(2, 4)t_3t_4t_3t_4t_3t_1t_3t_1t_2t_1t_3t_4. \\
&\Rightarrow [t_3, t_1][t_1, t_2] = (1, 3)(2, 4)t_3t_4t_3t_4t_3t_1t_3t_1t_2t_1t_3t_4. \\
&\Rightarrow [t_3, t_1][t_1, t_2] = (1, 3)(2, 4)t_3t_4t_3t_4(1, 3)(2, 4)t_3t_1t_3t_2t_1t_3t_4. \\
&\Rightarrow [t_3, t_1][t_1, t_2] = t_1t_2t_1t_2t_3t_1t_3t_2t_1t_3t_4. \\
&\Rightarrow [t_3, t_1][t_1, t_2] = t_1t_2t_1t_2t_3t_1t_3t_2(1, 4)(2, 3)t_4t_2t_4t_1. \\
&\Rightarrow [t_3, t_1][t_1, t_2] = (1, 4)(2, 3)t_4t_3t_4t_3t_2t_4t_2t_3t_4t_2t_4t_1. \\
&\Rightarrow [t_3, t_1][t_1, t_2] = (1, 4)(2, 3)t_4t_3t_4t_3t_2t_4t_2t_3t_4t_2t_4t_1. \\
&\Rightarrow [t_3, t_1][t_1, t_2]\underline{t_1t_4} = (1, 4)(2, 3)t_4t_3t_4t_3t_2t_4t_2t_3t_4t_2. \\
&\Rightarrow [t_3, t_1][t_1, t_2][t_4, t_1] = (1, 4)(2, 3)t_4t_3t_4(1, 4)(2, 3)t_3t_4t_2t_3t_4t_2. \\
&\Rightarrow [t_3, t_1][t_1, t_2][t_4, t_1] = t_1t_2t_1t_3t_4t_2t_3t_4t_2. \\
&\Rightarrow [t_3, t_1][t_1, t_2][t_4, t_1] = t_1t_2t_1t_3t_4t_2t_3t_4t_2. \\
&\Rightarrow [t_3, t_1][t_1, t_2][t_4, t_1] = t_1t_2t_1t_3t_4(1, 4)(2, 3)t_2t_4t_2. \\
&\Rightarrow [t_3, t_1][t_1, t_2][t_4, t_1] = (1, 4)(2, 3)t_4t_3t_4t_2t_1t_2t_4t_2. \\
&\Rightarrow [t_3, t_1][t_1, t_2][t_4, t_1] = (1, 4)(2, 3)t_4t_3t_4t_2t_1t_2t_4t_2. \\
&\Rightarrow [t_3, t_1][t_1, t_2][t_4, t_1] = (1, 4)(2, 3)t_4t_3t_4t_2t_1(1, 3)(2, 4)t_2t_4t_2t_4. \\
&\Rightarrow [t_3, t_1][t_1, t_2][t_4, t_1] = (1, 2)(3, 4)t_2t_1t_2t_4t_3t_2t_4t_2t_4. \\
&\Rightarrow [t_3, t_1][t_1, t_2][t_4, t_1]\underline{t_4t_2t_4t_2} = (1, 2)(3, 4)t_2t_1t_2t_4t_3. \\
&\Rightarrow [t_3, t_1][t_1, t_2][t_4, t_1][t_4, t_2] = \underline{(1, 2)(3, 4)t_2t_1t_2t_4t_3}. \\
&\Rightarrow [t_3, t_1][t_1, t_2][t_4, t_1][t_4, t_2] = t_2t_1t_2t_1t_2t_1t_4t_3. \\
&\Rightarrow [t_3, t_1][t_1, t_2][t_4, t_1][t_4, t_2] = t_2t_1t_2t_1t_2t_1t_4t_3. \\
&\Rightarrow [t_3, t_1][t_1, t_2][t_4, t_1][t_4, t_2] = t_2t_1t_2(1, 4)(2, 3)t_4t_3t_1t_3. \\
&\Rightarrow [t_3, t_1][t_1, t_2][t_4, t_1][t_4, t_2] = (1, 4)(2, 3)t_3t_4t_3t_4t_3t_1t_3. \\
&\Rightarrow [t_3, t_1][t_1, t_2][t_4, t_1][t_4, t_2] = (1, 4)(2, 3)\underline{t_3t_4t_3t_4t_3t_1t_3}. \\
&\Rightarrow [t_3, t_1][t_1, t_2][t_4, t_1][t_4, t_2] = (1, 4)(2, 3)(1, 2)(3, 4)t_3t_4t_3t_4t_1t_3. \\
&\Rightarrow [t_3, t_1][t_1, t_2][t_4, t_1][t_4, t_2] = (1, 3)(2, 4)t_3t_4t_3t_4t_1t_3. \\
&\Rightarrow [t_3, t_1][t_1, t_2][t_4, t_1][t_4, t_2] = (1, 3)(2, 4)t_3t_4t_3(1, 4)(2, 3)t_4t_3. \\
&\Rightarrow [t_3, t_1][t_1, t_2][t_4, t_1][t_4, t_2] = (1, 2)(3, 4)t_2t_1t_2t_4t_3. \\
&\Rightarrow [t_3, t_1][t_1, t_2][t_4, t_1][t_4, t_2] = (1, 2)(3, 4)t_2t_1t_2t_4t_3. \\
&\Rightarrow [t_3, t_1][t_1, t_2][t_4, t_1][t_4, t_2] = (1, 2)(3, 4)t_2t_1t_2t_4t_3. \\
&\Rightarrow [t_3, t_1][t_1, t_2][t_4, t_1][t_4, t_2] = (1, 2)(3, 4)t_2(1, 4)(2, 3)t_4t_3t_4t_1t_3. \\
&\Rightarrow [t_3, t_1][t_1, t_2][t_4, t_1][t_4, t_2] = (1, 3)(2, 4)t_3t_4t_3t_4t_1t_3.
\end{aligned}$$

$$\begin{aligned}
&\Rightarrow [t_3, t_1][t_1, t_2][t_4, t_1][t_4, t_2] = (1, 3)(2, 4)t_3t_4t_3t_4(1, 3)(2, 4)t_1t_3t_1t_3t_1. \\
&\Rightarrow [t_3, t_1][t_1, t_2][t_4, t_1][t_4, t_2] = t_1t_2t_1t_2t_1t_3t_1t_3t_1. \\
&\Rightarrow [t_3, t_1][t_1, t_2][t_4, t_1][t_4, t_2]\underline{t_1t_3t_1t_3} = t_1t_2t_1t_2t_1. \\
&\Rightarrow [t_3, t_1][t_1, t_2][t_4, t_1][t_4, t_2][t_1, t_3] = t_1t_2t_1t_2t_1. \\
&\Rightarrow [t_3, t_1][t_1, t_2][t_4, t_1][t_4, t_2][t_1, t_3]\underline{t_1t_2t_1t_2} = t_1. \\
&\Rightarrow [t_3, t_1][t_1, t_2][t_4, t_1][t_4, t_2][t_1, t_3][t_1, t_2] = t_1. \\
&\Rightarrow [t_3, t_1][t_1, t_2][t_4, t_1][t_4, t_2][t_1, t_3][t_1, t_2] \in G'.
\end{aligned}$$

We see the left side is belong to  $G'$ , so the right side is belong to  $G'$ .

$\Rightarrow t_1 \in G'$ , then we conjugate  $t_1$  by  $x$ ,  $y$ , and  $xy$  to get  $t_2$ ,  $t_3$ , and  $t_4$  respectively. So,  $G' \geq \langle t_1, t_2, t_3, t_4 \rangle$ , and we know that  $G = \langle t_1, t_2, t_3, t_4 \rangle$ .

So,  $G' \geq \langle t_1, t_2, t_3, t_4 \rangle = G$ , and  $G' \subseteq G$

$\Rightarrow G' = G$ . Thus,  $G$  is perfect.

**Step 3: Show there exists a normal ablian subgroup  $K \leq G$  such that  $K \triangleleft G_x$  and the conjugates of  $K$  generate  $G$ .**

We now that  $G_1 = N = 2^2$ , and  $N$  is a normal ablian subgroup of  $G$  has center 1.

So,  $K = N = \langle (1, 2)(3, 4), (1, 3)(2, 4) \rangle$ .

Let take  $(1, 4)(2, 3) \in K$ , and let use the relations  $t_1t_2t_1t_4 = (1, 4)(2, 3)t_4t_3t_1$

and  $t_1t_2t_1t_3t_4t_3t_4 = t_4t_3t_1t_2t_4t_3$  to find  $(1, 4)(2, 3)$ .

We will replace  $t_1t_2t_1$  in the first relation by using the second relation as the following,

$$t_1t_2t_1 = t_4t_3t_1t_2t_4t_3t_4t_3t_4.$$

$$\Rightarrow \underline{t_1t_2t_1}t_4 = (1, 4)(2, 3)t_4t_3t_1 \Rightarrow t_4t_3t_1t_2t_4t_3t_4t_3t_4t_3t_4t_3t_4 = (1, 4)(2, 3)t_4t_3t_1.$$

$$\Rightarrow t_4t_3t_1t_2t_4t_3t_4t_3t_4t_3t_4t_3t_4t_1t_3t_4 = (1, 4)(2, 3).$$

Since  $t_4t_3t_1t_2t_4t_3t_4t_3t_4t_3t_4t_3t_4t_1t_3t_4 \in K$  and  $t_4 \in G$

$$\text{We have } (t_4t_3t_1t_2t_4t_3t_4t_3t_4t_3t_4t_3t_4t_1t_3t_4)^{t_4} \in K^G$$

$$\Rightarrow (t_4)^{-1}(t_4t_3t_1t_2t_4t_3t_4t_3t_4t_3t_4t_3t_4t_1t_3t_4)(t_4) \in K^G$$

$$\Rightarrow t_4t_4t_3t_1t_2t_4t_3t_4t_3t_4t_3t_4t_3t_4t_1t_3t_4t_4 \in K^G$$

$$\Rightarrow t_3t_1t_2t_4t_3t_4t_3t_4t_3t_4t_1t_3 \in K^G$$

$$\Rightarrow t_3t_1t_2\underline{t_4t_3t_4t_3t_4t_3t_4}t_1t_3 \in K^G$$

$$\Rightarrow t_3t_1t_2(1, 2)(3, 4)t_4t_3t_1t_3 \in K^G$$

$$\Rightarrow (1, 2)(3, 4)t_4t_2t_1t_4t_3t_1t_3 \in K^G$$

$$\Rightarrow (1, 2)(3, 4)t_4t_2\underline{t_1t_4t_3t_1}t_3 \in K^G$$

$$\begin{aligned}
&\Rightarrow (1, 2)(3, 4)t_4t_2(1, 4)(2, 3)t_1t_3t_1t_3 \in K^G \\
&\Rightarrow (1, 3)(2, 4)t_1t_3t_1t_3t_1t_3 \in K^G \\
&\Rightarrow \underline{(1, 3)(2, 4)t_1t_3t_1t_3t_1t_3} \in K^G \\
&\Rightarrow t_1 \in K^G \\
&\Rightarrow K^G \supseteq \{t_1, t_1^x, t_1^y, t_1^{xy}\} \\
&\Rightarrow K^G \supseteq \{t_1, t_2, t_3, t_4\} = \langle t_1, t_2, t_3, t_4 \rangle = G \\
&\Rightarrow G = K^G.
\end{aligned}$$

*From steps (1), (2), and (3) we find that  $G$  is not simple group because  $G$  does not act primitively.*

## 7.2 Construction Of The Simple Group $L_2(13)$

### Double Coset Enumeration of $L_2(13)$ Over $M$ and $N$

We take the progenitor  $2^{*4} : 2^2$ , where  $2^{*4}$  is the free product of 4 copies of the cyclic groups of order 2, and  $2^2$  is the group of automorphisms of  $2^{*4}$  which permutes the four symmetric generators by conjugation and factor it by the three relations

$(xyx)^7 t_1 t_3 t_1 t_3 t_1 t_3 t_1 = 1$ ,  $(x)^3 t_1 t_2 t_1 = 1$ , and  $(xy)^{13} t_1 t_4 t_1 t_4 t_1 t_4 t_1 t_4 t_1 t_4 t_1 t_4 t_1 = 1$ . We see  $G$  is large group and Magma can not compute it's elements by using Schreier System. Then, we find the Maximal Subgroups of  $G$  call it  $M$  to decrease the cosets from 75 to 28 single coset.

We get that  $M = (S_3 : 2) = \langle x, y, y * t * (t^y) * (t^x) * (t^y) * t * ((t^x)^y) * t * (t^y) \rangle$ .

Now, We take the progenitor  $2^{*4} : (S_3 : 2)$ , where  $2^{*4}$  is the free product of 4 copies of the cyclic groups of order 2, and  $M$  is the group of automorphisms of  $2^{*4}$  which permutes the four symmetric generators by conjugation and factor it by above relations.

The double coset enumeration partitions the image of the group  $G$  as a union double cosets  $MgN$  where  $g \in 2^{*4} : 2^2$ . Thus, we can find the set of elements  $g_1, g_2, \dots$  of  $G$  such that  $G = Mg_1N \cup Mg_2N \cup \dots$ , and for each  $i$ , we have  $g_i = p_i w_i$ , where  $p_i \in M$ , and  $w_i$  is a word in the  $t_i$ s. Hence, the double coset decomposition is given by

$$G = Mw_1N \cup Mw_2N \cup Mw_3N \cup \dots,$$

where  $w_1 = e$  (the identity). We perform a double coset enumeration of the group  $\frac{2^{*4} : (S_3 : 2)}{[(xyx)t]^7, [xt]^3, [(xy)t]^{13}}$  over  $2^2$  and  $S_3 : 2$ . We will show

$$G = \frac{2^{*4} : 2^2}{[(xyx)t]^7, [xt]^3, [(xy)t]^{13}} \cong L_2(13).$$

A symmetric presentation of the progenitor  $2^{*4} : 2^2$  is given by:

$$2^{*4} : 2^2 \cong$$

$$\text{G}\langle x, y, t \rangle := \text{Group}\langle x, y, t \mid x^2, y^2, (x, y), t^2 \rangle;$$

$G$  factored by  $(x * y * x * t)^7 = 1$ ,  $(x * t)^3 = 1$ , and  $(x * y * t)^{15} = 1$  which simplifies to  $(xyx)^7 t_1 t_3 t_1 t_3 t_1 t_3 t_1 = 1$ ,  $(x)^3 t_1 t_2 t_1 = 1$ , and  $(xy)^{13} t_1 t_4 t_1 t_4 t_1 t_4 t_1 t_4 t_1 t_4 t_1 t_4 t_1 = 1$ .

We have  $N \cong 2^2 = \langle x, y \rangle$ , where  $x \sim (1, 2)(3, 4)$  and  $y \sim (1, 3)(2, 4)$ ,

$M = \langle x, y, y * t * (t^y) * (t^x) * (t^y) * t * ((t^x)^y) * t * (t^y) \rangle$ , and  $t = t_1$ . The order of  $M$  is 12.

**Using computer-based program - Magma :**

1. The order of the group,  $|G|$  is equal to 1092.
2. There are 28 double cosets in this double cosets enumeration of  $G$  over  $M$  and  $N$ .

**Relations**

We see that

$$(I) [(xyx)t]^7 = 1 \Rightarrow (xyx)^7 t^{(xyx)^6} t^{(xyx)^5} t^{(xyx)^4} t^{(xyx)^3} t^{(xyx)^2} t^{(xyx)^1} t^{(xyx)^0} = 1$$

$$\Rightarrow (1, 3)(2, 4)t_1 t_3 t_1 t_3 t_1 t_3 t_1 = 1 \Rightarrow M t_1 t_3 t_1 t_3 t_1 t_3 t_1 = 1.$$

Moreover, if we conjugate the previous relation by all elements in  $2^2 = \{e, (1, 2)(3, 4), (1, 3)(2, 4), (1, 4)(2, 3)\}$ , we obtain different relations.

1.  $((1, 3)(2, 4)t_1 t_3 t_1 t_3 t_1 t_3 t_1 = 1)^e \Rightarrow (1, 3)(2, 4)t_1 t_3 t_1 t_3 t_1 t_3 t_1 = 1.$
2.  $((1, 3)(2, 4)t_1 t_3 t_1 t_3 t_1 t_3 t_1 = 1)^{(1,2)(3,4)} \Rightarrow (2, 4)(1, 3)t_2 t_4 t_2 t_4 t_2 t_4 t_2 = 1.$
3.  $((1, 3)(2, 4)t_1 t_3 t_1 t_3 t_1 t_3 t_1 = 1)^{(1,3)(2,4)} \Rightarrow (3, 1)(4, 2)t_3 t_1 t_3 t_1 t_3 t_1 t_3 = 1.$
4.  $((1, 3)(2, 4)t_1 t_3 t_1 t_3 t_1 t_3 t_1 = 1)^{(1,4)(2,3)} \Rightarrow (4, 2)(3, 1)t_4 t_2 t_4 t_2 t_4 t_2 t_4 = 1.$

$$(II) [xt]^3 = 1 \Rightarrow (x)^3 t^{(x)^2} t^{(x)^1} t^{(x)^0} = 1$$

$$\Rightarrow (1, 2)(3, 4)t_1 t_2 t_1 = 1 \Rightarrow M t_1 t_2 t_1 = 1.$$

Moreover, if we conjugate the previous relation by all elements in  $2^2$ , we obtain

1.  $((1, 2)(3, 4)t_1 t_2 t_1 = 1)^e \Rightarrow (1, 2)(3, 4)t_1 t_2 t_1 = 1.$
2.  $((1, 2)(3, 4)t_1 t_2 t_1 = 1)^{(1,2)(3,4)} \Rightarrow (2, 1)(4, 3)t_2 t_1 t_2 = 1.$
3.  $((1, 2)(3, 4)t_1 t_2 t_1 = 1)^{(1,3)(2,4)} \Rightarrow (3, 4)(1, 2)t_3 t_4 t_3 = 1.$
4.  $((1, 2)(3, 4)t_1 t_2 t_1 = 1)^{(1,4)(2,3)} \Rightarrow (4, 3)(2, 1)t_4 t_3 t_4 = 1.$

$$(III) [(xy)t]^{13} = 1$$

$$\Rightarrow (xy)^{13} t^{(xy)^{12}} t^{(xy)^{11}} t^{(xy)^{10}} t^{(xy)^9} t^{(xy)^8} t^{(xy)^7} t^{(xy)^6} t^{(xy)^5} t^{(xy)^4} t^{(xy)^3} t^{(xy)^2} t^{(xy)^1} t^{(xy)^0} = 1$$

$$\Rightarrow (1, 4)(3, 2)t_1 t_4 t_1 t_4 t_1 t_4 t_1 t_4 t_1 t_4 t_1 t_4 t_1 t_4 t_1 = 1 \Rightarrow M t_1 t_4 t_1 t_4 t_1 t_4 t_1 t_4 t_1 t_4 t_1 t_4 t_1 t_4 t_1 = 1.$$

Moreover, if we conjugate the previous relation by all elements in  $2^2$ , we obtain

1.  $((1, 4)(3, 2)t_1 t_4 t_1 t_4 t_1 t_4 t_1 t_4 t_1 t_4 t_1 t_4 t_1 t_4 t_1 = 1)^e$   
 $\Rightarrow (1, 4)(3, 2)t_1 t_4 t_1 t_4 t_1 t_4 t_1 t_4 t_1 t_4 t_1 t_4 t_1 t_4 t_1 = 1.$
2.  $((1, 4)(3, 2)t_1 t_4 t_1 t_4 t_1 t_4 t_1 t_4 t_1 t_4 t_1 t_4 t_1 t_4 t_1 = 1)^{(1,2)(3,4)}$   
 $\Rightarrow (2, 3)(4, 1)t_2 t_3 t_2 t_3 t_2 t_3 t_2 t_3 t_2 t_3 t_2 t_3 t_2 t_3 t_2 = 1.$

3.  $((1, 4)(3, 2)t_1t_4t_1t_4t_1t_4t_1t_4t_1t_4t_1 = 1)^{(1,3)(2,4)}$   
 $\Rightarrow (3, 2)(1, 4)t_3t_2t_3t_2t_3t_2t_3t_2t_3t_2t_3 = 1.$
4.  $((1, 4)(3, 2)t_1t_4t_1t_4t_1t_4t_1t_4t_1t_4t_1 = 1)^{(1,4)(2,3)}$   
 $\Rightarrow (4, 1)(2, 3)t_4t_1t_4t_1t_4t_1t_4t_1t_4t_1t_4 = 1.$

### Double Coset $[\ast]$ :

We start with the double coset  $MeN$ , where  $e$  is the word of length zero denoted by  $[\ast]$ . It also can be represented as

$$MeN = \{Men : n \in N\} = \{Me\} = \{M\}$$

So, the double coset  $MeN$  consists of the single coset  $M$ . Thus,  $\frac{|N|}{|N|} = \frac{4}{4} = 1$ .

Note, since  $M$  is transitive on  $\{1, 2, 3, 4\}$ , we take a representative coset  $M$  from  $[\ast]$  and a representative from  $\{1, 2, 3, 4\}$  and determine the double coset to which  $Mt_i$  belongs, where  $i \in \{1, 2, 3, 4\}$ . We consider  $i = 1$ , so  $Mt_1$  is the representative coset, and hence we will have a new double coset  $Mt_1N$  which can denoted by  $[1]$ . There will be four possibles  $t_i$ s in  $[\ast]$  that will advance to the next double cosets  $[1]$ .

### Word of Length One $[1]$ :

We consider the double coset  $MwN$ , where  $w$  is a word of length one.  $Mt_1N = \{Mt_1^n | n \in N\} = [1]$ . We need to find the point stabilizer of 1. So,  $Mt_1N = [1] = \{Mt_1^n | n \in N\} = \{Mt_1N, Mt_2N, Mt_3N, Mt_4N\}$ . Since, the point stabilizer of 1 in the subgroup  $N$  is the permutations in  $N$  that fixes 1 and permute the rest of the element in the set  $\{1, 2, 3, 4\}$ . **Note:**  $N^{(1)} = \{n \in N | t_1^n = t_1\} \geq \langle e \rangle$ .

Since  $|N^{(1)}| = 1$  then the number of single cosets in  $[1]$  is  $\frac{|N|}{|N^{(1)}|} = \frac{4}{1} = 4$ .

Now, the orbits of  $N^{(1)}$  on  $\{1, 2, 3, 4\}$  are  $\{1\}$ ,  $\{2\}$ ,  $\{3\}$ , and  $\{4\}$ . We choose a representative from each orbit, and determine the double coset that contain  $Nt_1t_i$ , where  $i \in \{1, 2, 3, 4\}$ .

- $Mt_1 \cdot t_1 = Mt_1^2 = M \in [\ast]$ . This double coset will go back to  $[\ast]$ . Since there is one element in this orbit, there is one  $t_i$  that takes  $[1]$  to  $[\ast]$ .
- $Mt_1 \cdot t_2 = Mt_1t_2 = Mt_1 \in [1]$ . This double coset will collapse. Since there is one element in this orbit, there is one  $t_i$  that takes  $[1]$  to  $[1]$ .

- $Mt_1 \cdot t_3 = Mt_1t_3 \in [13]$ . This is a new double coset, which will extend the Cayley graph from [1] to [13]. Since there is one element in this orbit, there is one  $t_i$  that takes [1] to [13].
- $Mt_1 \cdot t_4 = Mt_1t_4 \in [14]$ . This is a new double coset, which extends our graph from [1] to [14]. Since there is one element in this orbit, there is one  $t_i$  that takes [1] to [14].

**Word of Length Two [13], and [14]:**

(i) We are at a new double coset [13],  $Mt_1t_3N = \{M(t_1t_3)^n | n \in N\}$ . Now, to determine all the single cosets of this double cosets, we need to determine the point stabilizer  $N^{13}$ , this means finding the set of elements that fix 1 and 3 in  $N$  and permutes the rest of the elements in the set  $\{1, 2, 3, 4\}$ . **Note:**  $N^{(13)} = \{n \in N | (t_1t_3)^n = t_1t_3\} \geq \langle e \rangle$ .

Since  $|N^{(13)}| = 1$  then the number of single cosets in [13] is  $\frac{|N|}{|N^{(13)}|} = \frac{4}{1} = 4$ .

Now, the orbits of  $N^{13}$  on  $\{1, 2, 3, 4\}$  are  $\{1\}$ ,  $\{2\}$ ,  $\{3\}$ , and  $\{4\}$ . We choose a representative from each orbit, and determine the double coset to which  $Nt_1t_i$  belongs for  $i = \{1, 2, 3, 4\}$ .

- $Mt_1t_3 \cdot t_1 = Mt_1t_3t_1 \in [131]$ . This is a new double coset, which extends our graph from [13] to [131]. Since there is one element in this orbit, there is one  $t_i$  that takes [13] to [131].
- $Mt_1t_3 \cdot t_2 = Mt_1t_3t_2 \in [132]$ . This is a new double coset, which extends our graph from [13] to [132]. Since there is one element in this orbit, there is one  $t_i$  that takes [13] to [132].
- $Mt_1t_3 \cdot t_3 = Mt_1t_3^2 \in [1]$ . This double coset will go back to [1]. Since there is one element in this orbit, there is one  $t_i$  that takes [13] to [1].
- $Mt_1t_3 \cdot t_4 = Mt_1t_3t_4 = Mt_2t_3 = Mt_1t_4 \in [14]$ . This double coset will send to [14]. Since there is one element in this orbit, there is one  $t_i$  that takes [13] to [14].

(ii) We are at a new double coset [14],  $Mt_1t_4N = \{M(t_1t_4)^n | n \in N\}$ . Now, to determine all the single cosets of this double cosets, we need to determine the point stabilizer  $N^{14}$ , this means finding the set of elements that fix 1 and 4 in  $N$  and permute the rest of the elements in the set  $\{1, 2, 3, 4\}$ . **Note:**  $N^{(14)} = \{n \in N | (t_1t_4)^n = t_1t_4\} \geq \langle e \rangle$ .

Since  $|N^{(14)}| = 1$  then the number of single cosets in [14] is  $\frac{|N|}{|N^{(14)}|} = \frac{4}{1} = 4$ .

Now, the orbits of  $N^{(14)}$  on  $\{1, 2, 3, 4\}$  are  $\{1\}$ ,  $\{2\}$ ,  $\{3\}$ , and  $\{4\}$ . We choose a representative from each orbit, and determine the double coset to which  $Nt_1t_4t_i$  belongs for  $i = \{1, 2, 3, 4\}$ .

- $Mt_1t_4 \cdot t_1 = Mt_1t_4t_1 \in [141]$ . This is a new double coset, which extends our graph from [14] to [141]. Since there is one element in this orbit, there is one  $t_i$  that takes [14] to [141].
- $Mt_1t_4 \cdot t_2 = Mt_1t_4t_2 \in [142]$ . This is a new double coset, which extends our graph from [14] to [142]. Since there is one element in this orbit, there is one  $t_i$  that takes [14] to [142].
- $Mt_1t_4 \cdot t_3 = Mt_1t_4t_3 = Mt_2t_4 = Mt_1t_3 \in [13]$ . This double coset will go to [13]. Since there is one element in this orbit, there is one  $t_i$  that takes [14] to [13].
- $Mt_1t_4 \cdot t_4 = Mt_1t_4^2 \in [1]$ . This double coset will go back to [1]. Since there is one element in this orbit, there is one  $t_i$  that takes [14] to [1].

**Word of Length Three** [131], [132], [141] and [142]:

(i) We are at a new double coset [131],  $Mt_1t_3t_1N = \{M(t_1t_3t_1)^n | n \in N\}$ . Now, to determine all the single cosets of this double cosets, we need to determine the point stabilizer  $N^{131}$ , this means finding the set of elements that fix 1, 3, and 1 in  $N$  and permute the rest of the elements in the set  $\{1, 2, 3, 4\}$ . **Note:**  $N^{(131)} = \{n \in N | (t_1t_3t_1)^n = t_1t_3t_1\} \geq \langle e \rangle$ . Since  $|N^{(131)}| = 1$  then the number of single cosets in [131] is  $\frac{|N|}{|N^{(131)}|} = \frac{4}{1} = 4$ . Now, the orbits of  $N^{(131)}$  on  $\{1, 2, 3, 4\}$  are  $\{1\}$ ,  $\{2\}$ ,  $\{3\}$ , and  $\{4\}$ . We choose a representative from each orbit, and determine the double coset to which  $Nt_1t_3t_1t_i$  belongs for  $i = \{1, 2, 3, 4\}$ .

- $Mt_1t_3t_1 \cdot t_1 = Mt_1t_3t_1^2 \in [13]$ . This double coset will go back to [13]. Since there is one element in this orbit, there is one  $t_i$  that takes [131] to [13].
- $Mt_1t_3t_1 \cdot t_2 = Mt_1t_3t_1t_2 = Mt_2t_4t_1 \in [132]$ . This double coset will go to [132]. Since there is one element in this orbit, there is one  $t_i$  that takes [131] to [132].
- $Mt_1t_3t_1 \cdot t_3 = Mt_1t_3t_1t_3 = Mt_1t_3t_1 \in [131]$ . This double coset will collapse. Since there is one element in this orbit, there is one  $t_i$  that takes [131] to [131].



- $Mt_1t_3t_1 \cdot t_4 \in [1314]$ . So that, this is a new double coset, which extends our graph from  $[131]$  to  $[1314]$ . Since there is one element in this orbit, there is one  $t_i$  that takes  $[131]$  to  $[1314]$ .

(ii) We are at a new double coset  $[132]$ ,  $Mt_1t_3t_2N = \{M(t_1t_3t_2)^n | n \in N\}$ . Now, to determine all the single cosets of this double cosets, we need to determine the point stabilizer  $N^{132}$ , this means finding the set of elements that fix 1, 3, and 2 in  $N$  and permute the rest of the elements in the set  $\{1, 2, 3, 4\}$ . **Note:**  $N^{(132)} = \{n \in N | (t_1t_3t_2)^n = t_1t_3t_2\} \geq \langle e \rangle$ . Since  $|N^{(132)}| = 1$  then the number of single cosets in  $[132]$  is  $\frac{|N|}{|N^{(132)}|} = \frac{4}{1} = 4$ . Now, the orbits of  $N^{(132)}$  on  $\{1, 2, 3, 4\}$  are  $\{1\}$ ,  $\{2\}$ ,  $\{3\}$ , and  $\{4\}$ . We choose a representative from each orbit, and determine the double coset to which  $Nt_1t_3t_2t_i$  belongs for  $i = \{1, 2, 3, 4\}$ .

- $Mt_1t_3t_2 \cdot t_1 = Mt_1t_3t_2t_1 = Mt_2t_4t_2 \in [131]$ . This double coset will go to  $[131]$ . Since there is one element in this orbit, there is one  $t_i$  that takes  $[132]$  to  $[131]$ .
- $Mt_1t_3t_2 \cdot t_2 = Mt_1t_3 \in [13]$ . This double coset will go back to  $[13]$ . Since there is one element in this orbit, there is one  $t_i$  that takes  $[132]$  to  $[13]$ .
- $Mt_1t_3t_2 \cdot t_3 \in [1323]$ . This is a new double coset, which extends our graph from  $[132]$  to  $[1323]$ . Since there is one element in this orbit, there is one  $t_i$  that takes  $[132]$  to  $[1323]$ .
- $Mt_1t_3t_2 \cdot t_4 \in [1324]$ . This is a new double coset, which extends our graph from  $[132]$  to  $[1324]$ . Since there is one element in this orbit, there is one  $t_i$  that takes  $[132]$  to  $[1324]$ .

(iii) We are at a new double coset  $[141]$ ,  $Mt_1t_4t_1N = \{M(t_1t_4t_1)^n | n \in N\}$ . Now, to determine all the single cosets of this double cosets, we need to determine the point stabilizer  $N^{141}$ , this means finding the set of elements that fix 1, 4, and 1 in  $N$  and permute the rest of the elements in the set  $\{1, 2, 3, 4\}$ . **Note:**  $N^{(141)} = \{n \in N | (t_1t_4t_1)^n = t_1t_4t_1\} \geq \langle e \rangle$ . Since  $|N^{(141)}| = 1$  then the number of single cosets in  $[141]$  is  $\frac{|N|}{|N^{(141)}|} = \frac{4}{1} = 4$ . Now, the orbits of  $N^{(141)}$  on  $\{1, 2, 3, 4\}$  are  $\{1\}$ ,  $\{2\}$ ,  $\{3\}$ , and  $\{4\}$ . We choose a representative from each orbit, and determine the double coset to which  $Nt_1t_4t_1t_i$  belongs for  $i = \{1, 2, 3, 4\}$ .

- $Mt_1t_4t_1 \cdot t_1 = Mt_1t_4t_1^2 \in [14]$ . This double coset will go back to [14]. Since there is one element in this orbit, there one  $t_i$  that takes [141] to [14].
- $Mt_1t_4t_1 \cdot t_2 = Mt_1t_4t_1t_2 = Mt_2t_4t_1 \in [142]$ . This double coset will go to [142]. Since there is one element in this orbit, there is one  $t_i$  that takes [141] to [142].
- $Mt_1t_4t_1 \cdot t_3 = Mt_1t_4t_1t_3 \in [1413]$ . So, this is a new double coset, which extends our graph from [141] to [1413]. Since there is one element in this orbit, there is one  $t_i$  that takes [141] to [1413].
- $Mt_1t_4t_1 \cdot t_4 \in [1414]$ . So, this is a new double coset, which extends our graph from [141] to [1414]. Since there is one element in this orbit, there is one  $t_i$  that takes [141] to [1414].

(iv) We are at a new double coset [142],  $Mt_1t_4t_2N = \{M(t_1t_4t_2)^n | n \in N\}$ . Now, to determine all the single cosets of this double cosets, we need to determine the point stabilizer  $N^{142}$ , this means finding the set of elements that fix 1, 4, and 2 in  $N$  and permute the rest of the elements in the set  $\{1, 2, 3, 4\}$ . **Note:**  $N^{(142)} = \{n \in N | (t_1t_4t_2)^n = t_1t_4t_2\} \geq \langle e \rangle$ . Since  $|N^{(142)}| = 1$  then the number of single cosets in [142] is  $\frac{|N|}{|N^{(142)}|} = \frac{4}{1} = 4$ . Now, the orbits of  $N^{(142)}$  on  $\{1, 2, 3, 4\}$  are  $\{1\}$ ,  $\{2\}$ ,  $\{3\}$ , and  $\{4\}$ . We choose a representative from each orbit, and determine the double coset to which  $Nt_1t_4t_2t_i$  belongs for  $i = \{1, 2, 3, 4\}$ .

- $Mt_1t_4t_2 \cdot t_1 = Mt_1t_4t_2t_1 = Mt_2t_3t_2 \in [141]$ . This double coset will go to [141]. Since there is one element in this orbit, there is one  $t_i$  that takes [142] to [141].
- $Mt_1t_4t_2 \cdot t_2 = Mt_1t_4 \in [14]$ . This double coset will go back to [14]. Since there is one element in this orbit, there is one  $t_i$  that takes [142] to [14].
- $Mt_1t_4t_2 \cdot t_3 \in [1423]$ . This is a new double coset, which extends our graph from [142] to [1423]. Since there is one element in this orbit, there is one  $t_i$  that takes [142] to [1423].
- $Mt_1t_4t_2 \cdot t_4 \in [1424]$ . This is a new double coset, which extends our graph from [142] to [1424]. Since there is one element in this orbit, there is one  $t_i$  that takes [142] to [1424].

**Word of Length four** [1314], [1323], [1324], [1413], [1414], [1423] **and** [1424]:

(i) We are at a new double coset [1314],  $Mt_1t_3t_1t_4N = \{M(t_1t_3t_1t_4)^n | n \in N\}$ . Now, to determine all the single cosets of this double cosets, we need to determine the point stabilizer  $N^{1314}$ , this means finding the set of elements that fix 1, 3, 1, and 4 in  $N$  and permute the rest of the elements in the set  $\{1, 2, 3, 4\}$ . **Note:**  $N^{(1314)} = \{n \in N | (t_1t_3t_1t_4)^n = t_1t_3t_1t_4\} \Rightarrow (t_1t_3t_1t_4)^{(1,2)(3,4)} = t_2t_4t_2t_3 = t_2t_4t_2(1,2)(3,4)t_3t_4 = (1,2)(3,4)t_1t_3t_1t_3t_4 = (1,2)(3,4)t_1t_3t_1t_3t_4 = (1,2)(3,4)(1,3)(2,4)t_1t_3t_1t_4 = (1,4)(2,3)t_1t_3t_1t_4 \geq \langle(1,2)(3,4)\rangle$ .

Since  $|N^{(1314)}| = 2$  then the number of single cosets in [1314] is  $\frac{|N|}{|N^{(1314)}|} = \frac{4}{2} = 2$ .

Now, the orbits of  $N^{(1314)}$  on  $\{1, 2, 3, 4\}$  are  $\{1, 2\}$  and  $\{3, 4\}$ . We choose a representative from each orbit, and determine the double coset to which  $Nt_1t_3t_1t_4t_i$  belongs for  $i = \{1, 4\}$ .

- $Mt_1t_3t_1t_4 \cdot t_1 \in [1314]$ . This is double coset will collapse. Since there are two elements in this orbit, there are 2  $t_i$ s that take [1314] to [1314].
- $Mt_1t_3t_1t_4 \cdot t_4 \in [131]$ . This double coset will go back to [131]. Since there are two elements in this orbit, there are 2  $t_i$ s that take [1314] to [131].

(ii) We are at a new double coset [1323],  $Mt_1t_3t_2t_3N = \{M(t_1t_3t_2t_3)^n | n \in N\}$ . Now, to determine all the single cosets of this double cosets, we need to determine the point stabilizer  $N^{1323}$ , this means finding the set of elements that fix 1, 3, 2, and 3 in  $N$  and permute the rest of the elements in the set  $\{1, 2, 3, 4\}$ .

**Note:**  $N^{(1323)} = \{n \in N | (t_1t_3t_2t_3)^n = t_1t_3t_2t_3\}$

$$\begin{aligned} \Rightarrow (t_1t_3t_2t_3)^{(1,3)(2,4)} &= t_3t_1t_4t_1 = (1,3)(2,4)t_3t_1t_3t_1t_3t_4t_1 \\ &= (1,3)(2,4)t_3t_1t_3t_1(1,2)(3,4)t_3t_1 = (1,4)(2,3)t_4t_2t_4t_2t_3t_1 = (1,2)(3,4)t_4t_2t_4t_3t_1 \\ &= t_3t_1t_4t_1 = t_1t_3t_2t_3 \geq \langle(1,3)(2,4)\rangle. \end{aligned}$$

Since  $|N^{(1323)}| = 2$  then the number of single cosets in [1323] is  $\frac{|N|}{|N^{(1323)}|} = \frac{4}{2} = 2$ .

Now, the orbits of  $N^{(1323)}$  on  $\{1, 2, 3, 4\}$  are  $\{1, 3\}$  and  $\{2, 4\}$ . We choose a representative from each orbit, and determine the double coset to which  $Nt_1t_3t_2t_3t_i$  belongs for  $i = \{3, 4\}$ .

- $Mt_1t_3t_2t_3 \cdot t_3 \in [132]$ . This double coset will go back to [132]. Since there are two elements in this orbit, there are 2  $t_i$ s that take [1323] to [132].
- $Mt_1t_3t_2t_3 \cdot t_4 = Mt_1t_3t_2t_3t_4 = Mt_2t_4t_1t_3 \in [1324]$ . This double coset will go to

[1324]. Since there are two elements in this orbit, there are 2  $t_i$ s that take [1323] to [1324].

(iii) We are at a new double coset [1324],  $Mt_1t_3t_2t_4N = \{M(t_1t_3t_2t_4)^n | n \in N\}$ . Now, to determine all the single cosets of this double cosets, we need to determine the point stabilizer  $N^{1324}$ , this means finding the set of elements that fix 1, 3, 2, and 4 in  $N$  and permute the rest of the elements in the set  $\{1, 2, 3, 4\}$ .

**Note:**  $N^{(1324)} = \{n \in N | (t_1t_3t_2t_4)^n = t_1t_3t_2t_4\} \geq \langle e \rangle$ .

Since  $|N^{(1324)}| = 1$  then the number of single cosets in [1324] is  $\frac{|N|}{|N^{(1324)}|} = \frac{4}{1} = 4$ .

Now, the orbits of  $N^{(1324)}$  on  $\{1, 2, 3, 4\}$  are  $\{1\}$ ,  $\{2\}$ ,  $\{3\}$ , and  $\{4\}$ . We choose a representative from each orbit, and determine the double coset to which  $Nt_1t_3t_2t_4t_i$  belongs for  $i = \{1, 2, 3, 4\}$ .

- $Mt_1t_3t_2t_4 \cdot t_1 \in [13241]$ . This is a new double coset, which extends our graph from [1324] to [13241]. Since there is one element in this orbit, there is one  $t_i$  that takes [1324] to [13241].
- $Mt_1t_3t_2t_4 \cdot t_2 \in [13242]$ . This is a new double coset, which extends our graph from [1324] to [13242]. Since there is one element in this orbit, there is one  $t_i$  that takes [1324] to [13242].
- $Mt_1t_3t_2t_4 \cdot t_3 = Mt_1t_3t_2t_4t_3 = Mt_2t_4t_1t_4 \in [1323]$ . This double coset will go to [1323]. Since there is one element in this orbit, there is one  $t_i$  that takes [1324] to [1323].
- $Mt_1t_3t_2t_4 \cdot t_4 \in [132]$ . This double coset will go back to [132]. Since there is one element in this orbit, there is one  $t_i$  that takes [1324] to [132].

(iv) We are at a new double coset [1413],  $Mt_1t_4t_1t_3N = \{M(t_1t_4t_1t_3)^n | n \in N\}$ . Now, to determine all the single cosets of this double cosets, we need to determine the point stabilizer  $N^{1413}$ , this means finding the set of elements that fix 1, 4, 1, and 3 in  $N$  and permute the rest of the elements in the set  $\{1, 2, 3, 4\}$ .

**Note:**  $N^{(1413)} = \{n \in N | (t_1t_4t_1t_3)^n = t_1t_4t_1t_3\} \geq \langle e \rangle$ .

Since  $|N^{(1413)}| = 1$  then the number of single cosets in [1413] is  $\frac{|N|}{|N^{(1413)}|} = \frac{4}{1} = 4$ .

Now, the orbits of  $N^{(1413)}$  on  $\{1, 2, 3, 4\}$  are  $\{1\}$ ,  $\{2\}$ ,  $\{3\}$ , and  $\{4\}$ . We choose a representative from each orbit, and determine the double coset to which  $Nt_1t_4t_1t_3t_i$  belongs for  $i = \{1, 2, 3, 4\}$ .

- $Mt_1t_4t_1t_3 \cdot t_1 \in [13242]$ . This double coset will go to  $[13242]$ . Since there is one element in this orbit, there is one  $t_i$  that takes  $[1413]$  to  $[13242]$ .
- $Mt_1t_4t_1t_3 \cdot t_2 \in [14132]$ . This is a new double coset, which extends our graph from  $[1413]$  to  $[14132]$ . Since there is one element in this orbit, there is one  $t_i$  that takes  $[1413]$  to  $[14132]$ .
- $Mt_1t_4t_1t_3 \cdot t_3 = Mt_1t_4t_1 \in [141]$ . This double coset will go back to  $[141]$ . Since there is one element in this orbit, there is one  $t_i$  that takes  $[1413]$  to  $[141]$ .
- $Mt_1t_4t_1t_3 \cdot t_4 = Mt_1t_4t_1t_3t_4 = Mt_2t_3t_2t_3 \in [1414]$ . This double coset will go to  $[1414]$ . Since there is one element in this orbit, there is one  $t_i$  that takes  $[1413]$  to  $[1414]$ .

(v) We are at a new double coset  $[1414]$ ,  $Mt_1t_4t_1t_4N = \{M(t_1t_4t_1t_4)^n | n \in N\}$ . Now, to determine all the single cosets of this double cosets, we need to determine the point stabilizer  $N^{1414}$ , this means finding the set of elements that fix 1, 4, 1, and 4 in  $N$  and permute the rest of the elements in the set  $\{1, 2, 3, 4\}$ .

**Note:**  $N^{(1414)} = \{n \in N | (t_1t_4t_1t_4)^n = t_1t_4t_1t_4\} \geq \langle e \rangle$ .

Since  $|N^{(1414)}| = 1$  then the number of single cosets in  $[1414]$  is  $\frac{|N|}{|N^{(1414)}|} = \frac{4}{1} = 4$ .

Now, the orbits of  $N^{(1414)}$  on  $\{1, 2, 3, 4\}$  are  $\{1\}$ ,  $\{2\}$ ,  $\{3\}$ , and  $\{4\}$ . We choose a representative from each orbit, and determine the double coset to which  $Nt_1t_4t_1t_4t_i$  belongs for  $i = \{1, 2, 3, 4\}$ .

- $Mt_1t_4t_1t_4 \cdot t_1 \in [14141]$ . This is a new double coset, which extends our graph from  $[1414]$  to  $[14141]$ . Since there is one element in this orbit, there is one  $t_i$  that takes  $[1414]$  to  $[14141]$ .
- $Mt_1t_4t_1t_4 \cdot t_2 \in [14142]$ . This is a new double coset, which extends our graph from  $[1414]$  to  $[14142]$ . Since there is one element in this orbit, there is one  $t_i$  that takes  $[1414]$  to  $[14142]$ .
- $Mt_1t_4t_1t_4 \cdot t_3 = Mt_1t_4t_1t_4t_3 = Mt_2t_3t_2t_4 \in [1413]$ . This double coset will go back to  $[1413]$ . Since there is one element in this orbit, there is one  $t_i$  that takes  $[1414]$  to  $[1413]$ .
- $Mt_1t_4t_1t_4 \cdot t_4 = Mt_1t_4t_1 \in [141]$ . This double coset will go back to  $[141]$ . Since there is one element in this orbit, there is one  $t_i$  that takes  $[1414]$  to  $[141]$ .

(vi) We are at a new double coset  $[1423]$ ,  $Mt_1t_4t_2t_3N = \{M(t_1t_4t_2t_3)^n | n \in N\}$ . Now, to determine all the single cosets of this double cosets, we need to determine the point stabilizer  $N^{1423}$ , this means finding the set of elements that fix 1, 4, 2, and 3 in  $N$  and permute the rest of the elements in the set  $\{1, 2, 3, 4\}$ .

**Note:**  $N^{(1423)} = \{n \in N | (t_1t_4t_2t_3)^n = t_1t_4t_2t_3\} \geq \langle e \rangle$ .

Since  $|N^{(1423)}| = 1$  then the number of single cosets in  $[1423]$  is  $\frac{|N|}{|N^{(1423)}|} = \frac{4}{1} = 4$ .

Now, the orbits of  $N^{(1423)}$  on  $\{1, 2, 3, 4\}$  are  $\{1\}$ ,  $\{2\}$ ,  $\{3\}$ , and  $\{4\}$ . We choose a representative from each orbit, and determine the double coset to which  $Nt_1t_4t_2t_3t_i$  belongs for  $i = \{1, 2, 3, 4\}$ .

- $Mt_1t_4t_2t_3 \cdot t_1 \in [14231]$ . This is a new double coset, which extends our graph from  $[1423]$  to  $[14231]$ . Since there is one element in this orbit, there is one  $t_i$  that takes  $[1423]$  to  $[14231]$ .
- $Mt_1t_4t_2t_3 \cdot t_2 \in [14232]$ . This is a new double coset, which extends our graph from  $[1423]$  to  $[14232]$ . Since there is one element in this orbit, there is one  $t_i$  that takes  $[1423]$  to  $[14232]$ .
- $Mt_1t_4t_2t_3 \cdot t_3 = Mt_1t_4t_2 \in [142]$ . This double coset will go back to  $[142]$ . Since there is one element in this orbit, there is one  $t_i$  that takes  $[1423]$  to  $[142]$ .
- $Mt_1t_4t_2t_3 \cdot t_4 = Mt_1t_4t_2t_3t_4 = Mt_2t_3t_1t_3 \in [1424]$ . This double coset will go back to  $[1424]$ . Since there is one element in this orbit, there is one  $t_i$  that takes  $[1423]$  to  $[1424]$ .

(vii) We are at a new double coset  $[1424]$ ,  $Mt_1t_4t_2t_4N = \{M(t_1t_4t_2t_4)^n | n \in N\}$ . Now, to determine all the single cosets of this double cosets, we need to determine the point stabilizer  $N^{1424}$ , this means finding the set of elements that fix 1, 4, 2, and 4 in  $N$  and permute the rest of the elements in the set  $\{1, 2, 3, 4\}$ .

**Note:**  $N^{(1424)} = \{n \in N | (t_1t_4t_2t_4)^n = t_1t_4t_2t_4\}$

$$\Rightarrow (t_1t_4t_2t_4)^{(1,3)(2,4)} = t_3t_2t_4t_2 = (1, 3)(2, 4)t_1t_2t_4t_2t_4 = (1, 4)(2, 3)t_1t_4t_2t_4$$

$\geq \langle (1, 3)(2, 4) \rangle$ . Since  $|N^{(1424)}| = 2$  then the number of single cosets in  $[1424]$  is  $\frac{|N|}{|N^{(1424)}|} = \frac{4}{2} = 2$ .

Now, the orbits of  $N^{(1424)}$  on  $\{1, 2, 3, 4\}$  are  $\{1, 3\}$  and  $\{2, 4\}$ . We choose a representative from each orbit, and determine the double coset to which  $Nt_1t_4t_2t_4t_i$  belongs for  $i = \{3, 4\}$ .

- $Mt_1t_4t_2t_4 \cdot t_3 = Mt_1t_4t_2t_4t_3 = Mt_2t_3t_1t_4 \in [1423]$ . This double coset will go back to  $[1423]$ . Since there are two elements in this orbit, there are 2  $t_i$ s that take  $[1424]$  to  $[1423]$ .
- $Mt_1t_4t_2t_4 \cdot t_4 = Mt_1t_4t_2 \in [142]$ . This double coset will go back to  $[142]$ . Since there are two elements in this orbit, there are 2  $t_i$ s that take  $[1424]$  to  $[142]$ .

**Word of Length five**  $[13241]$ ,  $[13242]$ ,  $[14132]$ ,  $[14141]$ ,  $[14142]$ ,  $[14231]$ , and  $[14232]$ :

(i) We are at a new double coset  $[13241]$ ,  $Mt_1t_3t_2t_4t_1N = \{M(t_1t_3t_2t_4t_1)^n | n \in N\}$ . Now, to determine all the single cosets of this double cosets, we need to determine the point stabilizer  $N^{13241}$ , this means finding the set of elements that fix 1, 3, 2, 4, and 1 in  $N$  and permute the rest of the elements in the set  $\{1, 2, 3, 4\}$ . **Note:**  $N^{(13241)} = \{n \in N | (t_1t_3t_2t_4t_1)^n = t_1t_3t_2t_4t_1\} \geq \langle e \rangle$ .

Since  $|N^{(13241)}| = 1$  then the number of single cosets in  $[13241]$  is  $\frac{|N|}{|N^{(13241)}|} = \frac{4}{1} = 4$ .

Now, the orbits of  $N^{(13241)}$  on  $\{1, 2, 3, 4\}$  are  $\{1\}$ ,  $\{2\}$ ,  $\{3\}$ , and  $\{4\}$ . We choose a representative from each orbit, and determine the double coset to which  $Nt_1t_3t_2t_4t_1t_i$  belongs for  $i = \{1, 2, 3, 4\}$ .

- $Mt_1t_3t_2t_4t_1 \cdot t_1 \in [1324]$ . This double coset will go back to  $[1324]$ . Since there is one element in this orbit, there is one  $t_i$  that takes  $[13241]$  to  $[1324]$ .
- $Mt_1t_3t_2t_4t_1 \cdot t_2 = Mt_1t_3t_2t_4t_1t_2 = Mt_2t_4t_1t_3t_1 \in [13242]$ . This double coset will go to  $[13242]$ . Since there is one element in this orbit, there is one  $t_i$  that takes  $[13241]$  to  $[13242]$ .
- $Mt_1t_3t_2t_4t_1 \cdot t_3 \in [132413]$ . This is a new double coset, which extends our graph from  $[13241]$  to  $[132413]$ . Since there is one element in this orbit, there is one  $t_i$  that takes  $[13241]$  to  $[132413]$ .
- $Mt_1t_3t_2t_4t_1 \cdot t_4 \in [132414]$ . This is a new double coset, which extends our graph from  $[13241]$  to  $[132414]$ . Since there is one element in this orbit, there is one  $t_i$  that takes  $[13241]$  to  $[132414]$ .

(ii) We are at a new double coset  $[13242]$ ,  $Mt_1t_3t_2t_4t_2N = \{M(t_1t_3t_2t_4t_2)^n | n \in N\}$ . Now, to determine all the single cosets of this double cosets, we need to determine the point stabilizer  $N^{13242}$ , this means finding the set of elements that fix 1, 3, 2, 4, and

2 in  $N$  and permute the rest of the elements in the set  $\{1, 2, 3, 4\}$ . **Note:**  $N^{(13242)} = \{n \in N \mid (t_1 t_3 t_2 t_4 t_2)^n = t_1 t_3 t_2 t_4 t_2\} \geq \langle e \rangle$ .

Since  $|N^{(13242)}| = 1$  then the number of single cosets in  $[13242]$  is  $\frac{|N|}{|N^{(13242)}|} = \frac{4}{1} = 4$ .

Now, the orbits of  $N^{(13242)}$  on  $\{1, 2, 3, 4\}$  are  $\{1\}$ ,  $\{2\}$ ,  $\{3\}$ , and  $\{4\}$ . We choose a representative from each orbit, and determine the double coset to which  $Nt_1 t_3 t_2 t_4 t_2 t_i$  belongs for  $i = \{1, 2, 3, 4\}$ .

- $Mt_1 t_3 t_2 t_4 t_2 \cdot t_1 = Mt_1 t_3 t_2 t_4 t_2 t_1 = Mt_2 t_4 t_1 t_3 t_2 \in [13241]$ . This double coset will go back to  $[13241]$ . Since there is one element in this orbit, there is one  $t_i$  that takes  $[13242]$  to  $[13241]$ .
- $Mt_1 t_3 t_2 t_4 t_2 \cdot t_2 = Mt_1 t_3 t_2 t_4 \in [1324]$ . This double coset will go back to  $[1324]$ . Since there is one element in this orbit, there is one  $t_i$  that takes  $[13242]$  to  $[1324]$ .
- $Mt_1 t_3 t_2 t_4 t_2 \cdot t_3 = Mt_1 t_3 t_2 t_4 t_2 t_3 = Mt_3 t_1 t_2 t_4 t_2 t_4 t_3 = Mt_4 t_1 t_4 t_2 t_4 t_3 = Mt_3 t_2 t_3 t_1 t_4 \in [14132]$ . This double coset will go back to  $[14132]$ . Since there is one element in this orbit, there is one  $t_i$  that takes  $[13242]$  to  $[14132]$ .
- $Mt_1 t_3 t_2 t_4 t_2 \cdot t_4 = Mt_1 t_3 t_2 t_4 t_2 t_4 = Mt_3 t_1 t_2 t_4 t_2 = Mt_4 t_1 t_4 t_2 \in [1413]$ . This double coset will go to  $[1413]$ . Since there is one element in this orbit, there is one  $t_i$  that takes  $[13242]$  to  $[1413]$ .

(iii) We are at a new double coset  $[14132]$ ,  $Mt_1 t_4 t_1 t_3 t_2 N = \{M(t_1 t_4 t_1 t_3 t_2)^n \mid n \in N\}$ . Now, to determine all the single cosets of this double cosets, we need to determine the point stabilizer  $N^{14132}$ , this means finding the set of elements that fix 1, 4, 1, 3, and 2 in  $N$  and permute the rest of the elements in the set  $\{1, 2, 3, 4\}$ . **Note:**

$$\begin{aligned}
N^{(14132)} &= \{n \in N \mid (t_1 t_4 t_1 t_3 t_2)^n = t_1 t_4 t_1 t_3 t_2\} \\
&\Rightarrow (t_1 t_4 t_1 t_3 t_2)^{(1,4)(2,3)} = t_4 t_1 t_4 t_2 t_3 = (1, 3)(2, 4)t_2 t_3 t_4 t_2 t_4 t_2 t_4 t_3 \\
&= (1, 3)(2, 4)t_2 t_3 t_4 t_2 t_4 t_2 t_4 t_3 = (1, 4)(2, 3)t_1 t_3 t_2 t_4 t_2 t_4 t_3 = (1, 3)(2, 4)t_2 t_4 t_1 t_3 t_1 t_4 \\
&= t_4 t_2 t_1 t_3 t_1 t_3 t_4 = (1, 2)(3, 4)t_3 t_2 t_3 t_1 t_3 t_4 \\
&= t_4 t_1 t_4 t_2 t_3 = t_1 t_4 t_1 t_3 t_2 \geq \langle (1, 4)(2, 3) \rangle.
\end{aligned}$$

Since  $|N^{(14132)}| = 2$  then the number of single cosets in  $[14132]$  is  $\frac{|N|}{|N^{(14132)}|} = \frac{4}{2} = 2$ .

Now, the orbits of  $N^{(14132)}$  on  $\{1, 2, 3, 4\}$  are  $\{1, 4\}$  and  $\{2, 3\}$ . We choose a representative from each orbit, and determine the double coset to which  $Nt_1 t_4 t_1 t_3 t_2 t_i$  belongs for  $i = \{1, 2\}$ .



- $Mt_1t_4t_1t_3t_2 \cdot t_1 = Mt_1t_4t_1t_3t_2t_1 = Mt_2t_3t_2t_4t_2 = Mt_4t_1t_2t_4t_2t_4 = Mt_3t_1t_4t_2t_4 \in [13242]$ . This double coset will go back to  $[13242]$ . Since there are two elements in this orbit, there are 2  $t_i$ s that take  $[14132]$  to  $[13242]$ .
- $Mt_1t_4t_1t_3t_2 \cdot t_2 \in [1413]$ . This double coset will go back to  $[1413]$ . Since there are two elements in this orbit, there are 2  $t_i$ s that take  $[14132]$  to  $[1413]$ .

(iv) We are at a new double coset  $[14141]$ ,  $Mt_1t_4t_1t_4t_1N$

$= \{M(t_1t_4t_1t_4t_1)^n | n \in N\}$ . Now, to determine all the single cosets of this double cosets, we need to determine the point stabilizer of  $N^{14141}$ , this means finding the set of elements that fix 1, 4, 1, 4, and 1 in  $N$  and permute the rest of the elements in the set  $\{1, 2, 3, 4\}$ .

**Note:**  $N^{(14141)} = \{n \in N | (t_1t_4t_1t_4t_1)^n = t_1t_4t_1t_4t_1\} \geq \langle e \rangle$ .

Since  $|N^{(14141)}| = 1$  then the number of single cosets in  $[14141]$  is  $\frac{|N|}{|N^{(14141)}|} = \frac{4}{1} = 4$ .

Now, the orbits of  $N^{(14141)}$  on  $\{1, 2, 3, 4\}$  are  $\{1\}$ ,  $\{2\}$ ,  $\{3\}$ , and  $\{4\}$ . We choose a representative from each orbit, and determine the double coset to which  $Nt_1t_4t_1t_4t_1t_i$  belongs for  $i = \{1, 2, 3, 4\}$ .

- $Mt_1t_4t_1t_4t_1 \cdot t_1 \in [1414]$ . This double coset will go back to  $[1414]$ . Since there is one element in this orbit, there is one  $t_i$  that takes  $[14141]$  to  $[1414]$ .
- $Mt_1t_4t_1t_4t_1 \cdot t_2 = Mt_1t_4t_1t_4t_1t_2 = Mt_2t_3t_2t_3t_1 \in [14142]$ . This double coset will back to  $[14142]$ . Since there is one element in this orbit, there is one  $t_i$  that takes  $[14141]$  to  $[14142]$ .
- $Mt_1t_4t_1t_4t_1 \cdot t_3 \in [132414]$ . This double coset will go to  $[132414]$ . Since there is one element in this orbit, there is one  $t_i$  that takes  $[14141]$  to  $[132414]$ .
- $Mt_1t_4t_1t_4t_1 \cdot t_4 \in [141414]$ . This is a new double coset, which extends our graph from  $[14141]$  to  $[141414]$ . Since there is one element in this orbit, there is one  $t_i$  that takes  $[14141]$  to  $[141414]$ .

(v) We are at a new double coset  $[14142]$ ,  $Mt_1t_4t_1t_4t_2N =$

$\{M(t_1t_4t_1t_4t_2)^n | n \in N\}$ . Now, to determine all the single cosets of this double cosets, we need to determine the point stabilizer  $N^{14142}$ , this means finding the set of elements that fix 1, 4, 1, 4, and 2 in  $N$  and permute the rest of the elements in the set  $\{1, 2, 3, 4\}$ .

**Note:**  $N^{(14142)} = \{n \in N | (t_1t_4t_1t_4t_2)^n = t_1t_4t_1t_4t_2\} \geq \langle e \rangle$ .

Since  $|N^{(14142)}| = 1$  then the number of single cosets in  $[14142]$  is  $\frac{|N|}{|N^{(14142)}|} = \frac{4}{1} = 4$ .

Now, the orbits of  $N^{(14142)}$  on  $\{1, 2, 3, 4\}$  are  $\{1\}$ ,  $\{2\}$ ,  $\{3\}$ , and  $\{4\}$ . We choose a representative from each orbit, and determine the double coset to which  $Nt_1t_4t_1t_4t_2t_i$  belongs for  $i = \{1, 2, 3, 4\}$ .

- $Mt_1t_4t_1t_4t_2 \cdot t_1 = Mt_1t_4t_1t_4t_2t_1$   
 $= Mt_2t_3t_2t_3t_2 \in [14141]$ . This double coset will go back to  $[14141]$ . Since there is one element in this orbit, there is one  $t_i$  that takes  $[14142]$  to  $[14141]$ .
- $Mt_1t_4t_1t_4t_2 \cdot t_2 \in [1414]$ . This double coset will go back to  $[1414]$ . Since there is one element in this orbit, there is one  $t_i$  that takes  $[14142]$  to  $[1414]$ .
- $Mt_1t_4t_1t_4t_2 \cdot t_3 \in [14142]$ . This double coset will collapse. Since there is one element in this orbit, there is one  $t_i$  that takes  $[14142]$  to  $[14142]$ .
- $Mt_1t_4t_1t_4t_2 \cdot t_4 \in [141424]$ . This is a new double coset, which extends our graph from  $[14142]$  to  $[141424]$ . Since there is one element in this orbit, there is one  $t_i$  that takes  $[14142]$  to  $[141424]$ .

(vi) We are at a new double coset  $[14231]$ ,  $Mt_1t_4t_2t_3t_1N$

$= \{M(t_1t_4t_2t_3t_1)^n | n \in N\}$ . Now, to determine all the single cosets of this double cosets, we need to determine the point stabilizer  $N^{14231}$ , this means finding the set of elements that fix 1, 4, 2, 3, and 1 in  $N$  and permute the rest of the elements in the set  $\{1, 2, 3, 4\}$ .

**Note:**  $N^{(14231)} = \{n \in N | (t_1t_4t_2t_3t_1)^n = t_1t_4t_2t_3t_1\} \geq \langle e \rangle$ .

Since  $|N^{(14231)}| = 1$  then the number of single cosets in  $[14231]$  is  $\frac{|N|}{|N^{(14231)}|} = \frac{4}{1} = 4$ .

Now, the orbits of  $N^{(14231)}$  on  $\{1, 2, 3, 4\}$  are  $\{1\}$ ,  $\{2\}$ ,  $\{3\}$ , and  $\{4\}$ . We choose a representative from each orbit, and determine the double coset to which  $Nt_1t_4t_2t_3t_1t_i$  belongs for  $i = \{1, 2, 3, 4\}$ .

- $Mt_1t_4t_2t_3t_1 \cdot t_1 \in [1423]$ . This double coset will go back to  $[1423]$ . Since there is one element in this orbit, there is one  $t_i$  that takes  $[14231]$  to  $[1423]$ .
- $Mt_1t_4t_2t_3t_1 \cdot t_2 = Mt_1t_4t_2t_3t_1t_2 = Mt_2t_3t_1t_4t_1 \in [14232]$ . This double coset will go back to  $[14232]$ . Since there is one element in this orbit, there is one  $t_i$  that takes  $[14231]$  to  $[14232]$ .
- $Mt_1t_4t_2t_3t_1 \cdot t_3 \in [141424]$ . This double coset will go to  $[141424]$ . Since there is one element in this orbit, there is one  $t_i$  that takes  $[14231]$  to  $[141424]$ .

- $Mt_1t_4t_2t_3t_1 \cdot t_4 \in [14231]$ . This double coset will collapse. Since there is one element in this orbit, there is one  $t_i$  that takes  $[14231]$  to  $[14231]$ .

(vii) We are at a new double coset  $[14232]$ ,  $Mt_1t_4t_2t_3t_2N = \{M(t_1t_4t_2t_3t_2)^n | n \in N\}$ . Now, to determine all the single cosets of this double cosets, we need to determine the point stabilizer  $N^{14232}$ , this means finding the set of elements that fix 1, 4, 2, 3, and 2 in  $N$  and permute the rest of the elements in the set  $\{1, 2, 3, 4\}$ . **Note:**

$$N^{(14232)} = \{n \in N | (t_1t_4t_2t_3t_2)^n = t_1t_4t_2t_3t_2\}$$

$$\Rightarrow (t_1t_4t_2t_3t_2)^{(1,4)(2,3)} = t_4t_1t_3t_2t_3 = t_1t_4t_1t_3t_2 \geq \langle (1, 4)(2, 3) \rangle.$$

Since  $|N^{(14232)}| = 2$  then the number of single cosets in  $[14232]$  is  $\frac{|N|}{|N^{(14232)}|} = \frac{4}{2} = 2$ .

Now, the orbits of  $N^{(14232)}$  on  $\{1, 2, 3, 4\}$  are  $\{1, 4\}$  and  $\{2, 3\}$ . We choose a representative from each orbit, and determine the double coset to which  $Nt_1t_4t_2t_3t_2t_i$  belongs for  $i = \{1, 2\}$ .

- $Mt_1t_4t_2t_3t_2 \cdot t_1 = Mt_1t_4t_2t_3t_2t_1 = Mt_2t_3t_1t_4t_2 \in [14231]$ . This double coset will back to  $[14231]$ . Since there are two elements in this orbit, there are 2  $t_i$ s that take  $[14232]$  to  $[14231]$ .
- $Mt_1t_4t_2t_3t_2 \cdot t_2 \in [1423]$ . This double coset will back to  $[1423]$ . Since there are two elements in this orbit, there are 2  $t_i$ s that take  $[14232]$  to  $[1423]$ .

**Word of Length six**  $[132413]$ ,  $[132414]$ ,  $[141414]$ , **and**  $[141424]$ :

(i) We are at a new double coset  $[132413]$ ,  $Mt_1t_3t_2t_4t_1t_3N = \{M(t_1t_3t_2t_4t_1t_3)^n | n \in N\}$ . Now, to determine all the single cosets of this double cosets, we need to determine the point stabilizer  $N^{132413}$ , this means finding the set of elements that fix 1, 3, 2, 4, 1, and 3 in  $N$  and permute the rest of the elements in the set  $\{1, 2, 3, 4\}$ . **Note:**  $N^{(132413)} = \{n \in N | (t_1t_3t_2t_4t_1t_3)^n = t_1t_3t_2t_4t_1t_3\} \geq \langle e \rangle$ .

Since  $|N^{(132413)}| = 1$  then the number of single cosets in  $[132413]$  is  $\frac{|N|}{|N^{(132413)}|} = \frac{4}{1} = 4$ .

Now, the orbits of  $N^{(132413)}$  on  $\{1, 2, 3, 4\}$  are  $\{1\}$ ,  $\{2\}$ ,  $\{3\}$ , and  $\{4\}$ . We choose a representative from each orbit, and determine the double coset to which  $Nt_1t_3t_2t_4t_1t_3t_i$  belongs for  $i = \{1, 2, 3, 4\}$ .

- $Mt_1t_3t_2t_4t_1t_3 \cdot t_1 \in [132413]$ . This double coset will collapse to  $[132413]$ . Since there is one element in this orbit, there is one  $t_i$  that takes  $[132413]$  to  $[132413]$ .

- $Mt_1t_3t_2t_4t_1t_3 \cdot t_2 \in [132412]$ . This is a new double coset, which extends our graph from  $[132413]$  to  $[132412]$ . Since there is one element in this orbit, there is one  $t_i$  that takes  $[132413]$  to  $[132412]$ .
- $Mt_1t_3t_2t_4t_1t_3 \cdot t_3 \in [132413]$ . This double coset will go back to  $[13241]$ . Since there is one element in this orbit, there is one  $t_i$  that takes  $[132413]$  to  $[13241]$ .
- $Mt_1t_3t_2t_4t_1t_3 \cdot t_4 = Mt_1t_3t_2t_4t_1t_3t_4 = Mt_2t_4t_1t_3t_2t_3 \in [132414]$ . This double coset will go to  $[132414]$ . Since there is one element in this orbit, there is one  $t_i$  that takes  $[132413]$  to  $[132414]$ .

(ii) We are at a new double coset  $[132414]$ ,  $Mt_1t_3t_2t_4t_1t_4N = \{M(t_1t_3t_2t_4t_1t_4)^n | n \in N\}$ . Now, to determine all the single cosets of this double cosets, we need to determine the point stabilizer  $N^{132414}$ , this means finding the set of elements that fix 1, 3, 2, 4, 1, and 4 in  $N$  and permute the rest of the elements in the set  $\{1, 2, 3, 4\}$ . **Note:**  $N^{(132414)} = \{n \in N | (t_1t_3t_2t_4t_1t_4)^n = t_1t_3t_2t_4t_1t_4\} \geq \langle e \rangle$ .

Since  $|N^{(132414)}| = 1$  then the number of single cosets in  $[132414]$  is  $\frac{|N|}{|N^{(132414)}|} = \frac{4}{1} = 4$ .

Now, the orbits of  $N^{(132414)}$  on  $\{1, 2, 3, 4\}$  are  $\{1\}$ ,  $\{2\}$ ,  $\{3\}$ , and  $\{4\}$ . We choose a representative from each orbit, and determine the double coset to which  $Nt_1t_3t_2t_4t_1t_4t_i$  belongs for  $i = \{1, 2, 3, 4\}$ .

- $Mt_1t_3t_2t_4t_1t_4 \cdot t_1 \in [141414]$ . This double coset will go to  $[141414]$ . Since there is one element in this orbit, there is one  $t_i$  that takes  $[132414]$  to  $[141414]$ .
- $Mt_1t_3t_2t_4t_1t_4 \cdot t_2 \in [14141]$ . This is a new double coset, which extends our graph from  $[132414]$  to  $[14141]$ . Since there is one element in this orbit, there is one  $t_i$  that takes  $[132414]$  to  $[14141]$ .
- $Mt_1t_3t_2t_4t_1t_4 \cdot t_3 = Mt_1t_3t_2t_4t_1t_4t_3 = Mt_2t_4t_1t_3t_2t_4 \in [132413]$ . This double coset will go back to  $[132413]$ . Since there is one element in this orbit, there is one  $t_i$  that takes  $[132414]$  to  $[132413]$ .
- $Mt_1t_3t_2t_4t_1t_4 \cdot t_4 \in [13241]$ . This double coset will back to  $[13241]$ . Since there is one element in this orbit, there is one  $t_i$ s that extend  $[132414]$  to  $[13241]$ .

(iii) We are at a new double coset  $[141414]$ ,  $Mt_1t_4t_1t_4t_1t_4N$   
 $= \{M(t_1t_4t_1t_4t_1t_4)^n | n \in N\}$ . Now, to determine all the single cosets of this double cosets,  
we need to determine the point stabilizer  $N^{141414}$ , this means finding the set of elements  
that fix 1, 4, 1, 4, 1, and 4 in  $N$  and permute the rest of the elements in the set  $\{1, 2, 3, 4\}$ .

**Note:**  $N^{(141414)} = \{n \in N | (t_1t_4t_1t_4t_1t_4)^n = t_1t_4t_1t_4t_1t_4\} \geq \langle e \rangle$ .

Since  $|N^{(141414)}| = 1$  then the number of single cosets in  $[141414]$  is  $\frac{|N|}{|N^{(141414)}|} = \frac{4}{1} = 4$ .

Now, the orbits of  $N^{(141414)}$  on  $\{1, 2, 3, 4\}$  are  $\{1\}$ ,  $\{2\}$ ,  $\{3\}$ , and  $\{4\}$ . We choose a  
representative from and determine the double coset to which  $Nt_1t_4t_1t_4t_1t_4t_i$  belongs for  
 $i = \{1, 2, 3, 4\}$ .

- $Mt_1t_4t_1t_4t_1t_4 \cdot t_1 = Mt_1t_4t_1t_4t_1t_4t_1 = Mt_1t_4t_1t_4t_1t_4 \in [141414]$ . This double coset  
will collapse to  $[141414]$ . Since there is one element in this orbit, there is one  $t_i$  that  
takes  $[141414]$  to  $[141414]$ .
- $Mt_1t_4t_1t_4t_1t_4 \cdot t_2 \in [1414142]$ . This is a new double coset will go to  $[1414142]$ , which  
extends our graph from  $[141414]$  to  $[1414142]$ . Since there is one element in this  
orbit, there is one  $t_i$  that takes  $[141414]$  to  $[1414142]$ .
- $Mt_1t_4t_1t_4t_1t_4 \cdot t_3 \in [132414]$ . This double coset will go to  $[132414]$ . Since there is  
one element in this orbit, there is one  $t_i$  that takes  $[141414]$  to  $[132414]$ .
- $Mt_1t_4t_1t_4t_1t_4 \cdot t_4 \in [14141]$ . This double coset will go back to  $[14141]$ . Since there  
is one element in this orbit, there is one  $t_i$  that takes  $[141414]$  to  $[14141]$ .

(iv) We are at a new double coset  $[141424]$ ,  $Mt_1t_4t_1t_4t_2t_4N$   
 $= \{M(t_1t_4t_1t_4t_2t_4)^n | n \in N\}$ . Now, to determine all the single cosets of this double cosets,  
we need to determine the point stabilizer  $N^{141424}$ , this means finding the set of elements  
that fix 1, 4, 1, 4, 2, and 4 in  $N$  and permute the rest of the elements in the set  $\{1, 2, 3, 4\}$ .

**Note:**  $N^{(141424)} = \{n \in N | (t_1t_4t_1t_4t_2t_4)^n = t_1t_4t_1t_4t_2t_4\}$

$\Rightarrow (t_1t_4t_1t_4t_2t_4)^{(1,2)(3,4)} = t_2t_3t_2t_3t_1t_3 = t_1t_4t_1t_4t_2t_4 \geq \langle (1,2)(3,4) \rangle$ .

Since  $|N^{(141424)}| = 2$  then the number of single cosets in  $[141424]$  is  $\frac{|N|}{|N^{(141424)}|} = \frac{4}{2} = 2$ .

Now, the orbits of  $N^{(141424)}$  on  $\{1, 2, 3, 4\}$  are  $\{1, 2\}$  and  $\{3, 4\}$ . We choose a representative  
from each orbit, and determine the double coset to which  $Nt_1t_4t_1t_4t_2t_4t_i$  belongs for  
 $i = \{2, 4\}$ .

- $Mt_1t_4t_1t_4t_2t_4 \cdot t_2 = Mt_1t_4t_1t_4t_2t_4t_2 = Mt_3t_2t_3t_4t_2t_4 = Mt_4t_1t_3t_2t_4 \in [14231]$ . This

double coset will go back to [14231]. Since there are two elements in this orbit, there are 2  $t_i$ s that take [141424] to [14231].

- $Mt_1t_4t_1t_4t_2t_4 \cdot t_4 \in [14142]$ . This double coset will go back to [1423]. Since there are two elements in this orbit, there are 2  $t_i$ s that take [141424] to [14142].

**Word of Length seven [1324132] and [1414142]:**

(i) We are at a new double coset [1324132],

$Mt_1t_3t_2t_4t_1t_3t_2N = \{M(t_1t_3t_2t_4t_1t_3t_2)^n | n \in N\}$ . Now, to determine all the single cosets of this double cosets, we need to determine the point stabilizer  $N^{1324132}$ , this means finding the set of elements that fix 1, 4, 1, 4, 1, 4, and 2 in  $N$  and permute the rest of the elements in the set  $\{1, 2, 3, 4\}$ .

**Note:**  $N^{(1324132)} = \{n \in N | (t_1t_3t_2t_4t_1t_3t_2)^n = t_1t_3t_2t_4t_1t_3t_2\} \geq \langle (1, 2)(3, 4), (1, 3)(2, 4), (1, 4)(2, 3) \rangle$ . Since  $|N^{(1324132)}| = 4$  then the number of single cosets in [1324132] is  $\frac{|N|}{|N^{(1324132)}|} = \frac{4}{4} = 1$ .

Now, the orbits of  $N^{(1324132)}$  on  $\{1, 2, 3, 4\}$  are  $\{1, 2, 3, 4\}$ . If we choose a representative from that orbit we will go back to [132413].

(ii) We are at a new double coset [1414142],

$Mt_1t_4t_1t_4t_1t_4t_2N = \{M(t_1t_4t_1t_4t_1t_4t_2)^n | n \in N\}$ . Now, to determine all the single cosets of this double cosets, we need to determine the point stabilizer  $N^{1414142}$ , this means finding the set of elements that fix 1, 4, 1, 4, 1, 4, and 2 in  $N$  and permute the rest of the elements in the set  $\{1, 2, 3, 4\}$ .

**Note:**  $N^{(1414142)} = \{n \in N | (t_1t_4t_1t_4t_1t_4t_2)^n = t_1t_4t_1t_4t_1t_4t_2\} \geq \langle (1, 2)(3, 4), (1, 3)(2, 4), (1, 4)(2, 3) \rangle$ .

Since  $|N^{(1414142)}| = 4$  then the number of single cosets in [1414142] is  $\frac{|N|}{|N^{(1414142)}|} = \frac{4}{4} = 1$ .

Now, the orbits of  $N^{(1414142)}$  on  $\{1, 2, 3, 4\}$  are  $\{1, 2, 3, 4\}$ . If we choose a representative from that orbit we will go back to [141414].

**Conclusion:**

The double coset enumeration gives that

$$\begin{aligned} |G| \leq & (|M| + |Mt_1N| + |Mt_1t_3N| + |Mt_1t_4N| + |Mt_1t_3t_1N| + |Mt_1t_3t_2N| \\ & + |Mt_1t_4t_1N| + |Mt_1t_4t_2N| + |Mt_1t_3t_1t_4N| + |Mt_1t_3t_2t_3N| + |Mt_1t_3t_2t_4N| \\ & + |Mt_1t_4t_1t_3N| + |Mt_1t_4t_1t_4N| + |Mt_1t_4t_2t_3N| + |Mt_1t_4t_2t_4N| \end{aligned}$$

$$\begin{aligned}
& + |Mt_1t_3t_2t_4t_1N| + |Mt_1t_3t_2t_4t_2N| + |Mt_1t_4t_1t_3t_2N| \\
& + |Mt_1t_4t_1t_4t_1N| + |Mt_1t_4t_1t_4t_2N| + |Mt_1t_4t_2t_3t_1N| + |Mt_1t_4t_2t_3t_2N| \\
& + |Mt_1t_3t_2t_4t_1t_3N| + |Mt_1t_3t_2t_4t_1t_4N| + |Mt_1t_4t_1t_4t_1t_4N| + |Mt_1t_4t_1t_4t_2t_4N| \\
& + |Mt_1t_3t_2t_4t_1t_3t_2N| + |Mt_1t_4t_1t_4t_1t_4t_2N|) \times |M| \\
& = (1 + 4 + 4 + 4 + 4 + 4 + 4 + 4 + 2 + 2 + 4 + 4 + 4 + 4 + 2 + 4 + 4 + 2 \\
& + 4 + 4 + 4 + 2 + 4 + 4 + 4 + 2 + 1 + 1) \times 12 \\
& = (91 \times 12) = 1092. \text{ A Cayley diagram of } G \text{ over } L_2(13) \text{ is given below.}
\end{aligned}$$

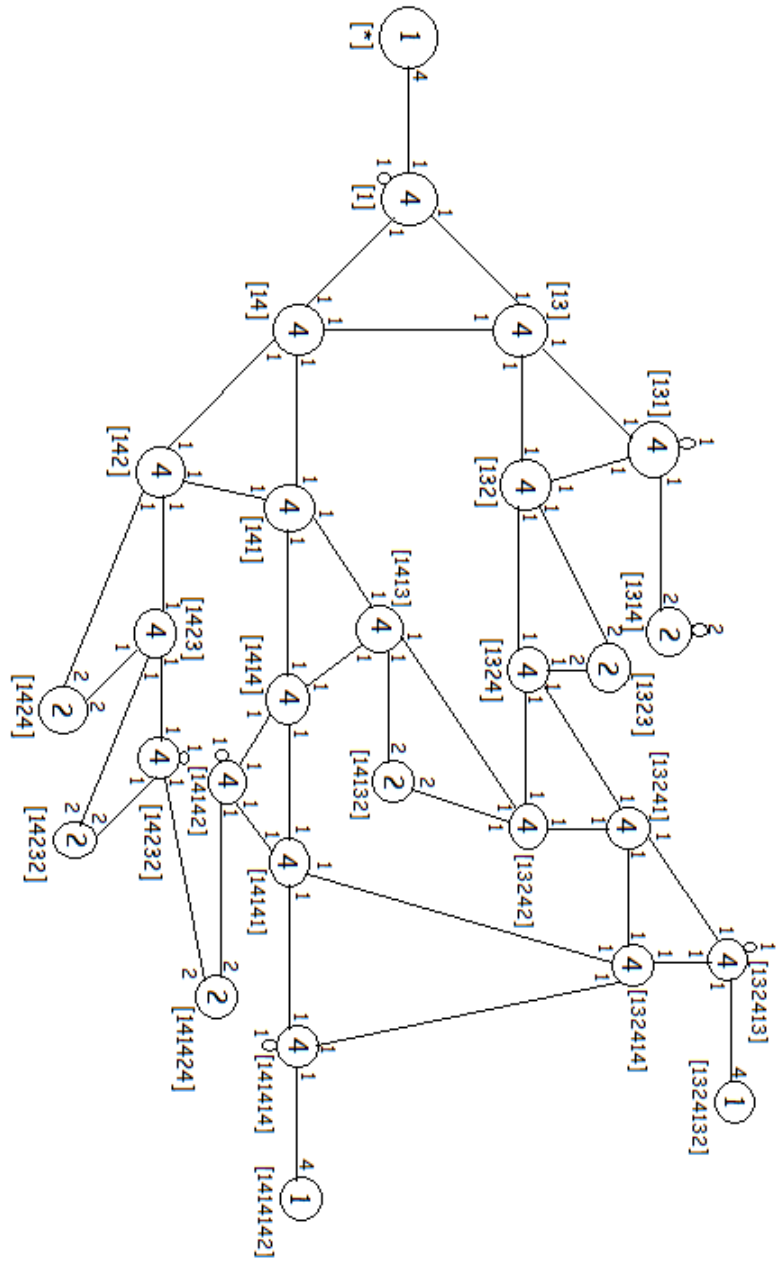

Figure 7.1: Cayley Diagram for  $L_2(13)$  Over  $M$  and  $N$



**Example 7.6.** We prove the following group is simple by using its Cayley diagram.

$$G = \frac{2^{*4} : S_3 : 2}{[(xyx)t]^7, [xt]^3, [(xy)t]^{13}} \cong L_2(13)$$

**Solution:** In order to prove  $G$  is simple, we need to show;

**Step 1:** ( $G$  acts faithfully and primitively)

(i) Suppose we have the  $G$ -set call it  $X$ , then to show  $G$  is primitive we will show that  $G$  is transitive and has no nontrivial blocks of  $X$  under the action  $G$ .

By using the Cayley diagram of  $G$ , we have

$$X = \{M, Mt_1, Mt_2, Mt_3, Mt_4, \dots, Mt_1t_4t_1t_4t_1t_4t_2\}, \Rightarrow |X| = 91.$$

We know  $X$  is transitive  $G$ -set by using the diagram (since any group  $G$  represented by a Cayley diagram is transitive). Next, we note that if  $B$  is a block of  $X$  under the action of  $G$  then  $|B|$  has to divide  $|X|$ ,

So, possible orders of  $B$  are positive divisors of 91. Thus  $|B| = 1, 7, 13, 91$ .

We will discard the orders 1 and 91 because these are trivial blocks. Now, a nontrivial block must be of size 7, or 13. From the Cayley diagram we see that a nontrivial block of size 7 is impossible. We rule out the possibility of a nontrivial block of size 13, here is an example,

Suppose,  $|B| = 13$ , and  $B = \{Mt_1t_4t_1t_4t_1t_4t_2N, Mt_1t_4t_1t_4t_1t_4N, Mt_1t_4t_1t_4t_1N, Mt_1t_3t_2t_4t_1t_4N\}$ , then

$$B = \{Mt_1t_4t_1t_4t_1t_4t_2, Mt_1t_4t_1t_4t_1t_4, Mt_2t_3t_2t_3t_2t_3, Mt_4t_1t_4t_1t_4t_1, Mt_3t_2t_3t_2t_3t_2, Mt_1t_4t_1t_4t_1, Mt_2t_3t_2t_3t_2, Mt_4t_1t_4t_1t_4, Mt_3t_2t_3t_2t_3, Mt_1t_3t_2t_4t_1t_4, Mt_2t_4t_1t_3t_2t_3, Mt_3t_1t_4t_2t_3t_2, Mt_4t_2t_3t_1t_4t_1\}.$$

1.  $Bt_1 = \{Mt_2t_3t_2t_3t_2t_3t_2, Mt_1t_4t_1t_4t_1t_4t_1, Mt_2t_3t_2t_3t_2t_3t_1, Mt_4t_1t_4t_1t_4, Mt_4t_1t_4t_1t_4t_2, Mt_1t_4t_1t_4, Mt_1t_4t_1t_4t_2, Mt_4t_1t_4t_1t_4t_1, Mt_3t_2t_3t_2t_3t_1, Mt_1t_3t_2t_4t_1t_4t_1, Mt_2t_4t_1t_3t_2t_3t_1, Mt_4t_2t_3t_1t_4t_2, Mt_4t_2t_3t_1t_4\}$ .
2.  $Bt_2 = \{Mt_1t_4t_1t_4t_1t_4, Mt_1t_4t_1t_4t_1t_4t_2, Mt_2t_3t_2t_3t_2t_3t_2, Mt_3t_2t_3t_2t_3t_1, Mt_3t_2t_3t_2t_3, Mt_2t_3t_2t_3t_1, Mt_2t_3t_2t_3, Mt_4t_1t_4t_1t_4t_2, Mt_3t_2t_3t_2t_3t_2, Mt_1t_3t_2t_4t_1t_4t_2, Mt_2t_4t_1t_3t_2t_3t_2, Mt_3t_1t_4t_2t_3, Mt_3t_1t_4t_2t_3t_1\}$ .
3.  $Bt_3 = \{Mt_1t_4t_1t_4t_1t_4t_2t_3, Mt_2t_3t_2t_3t_2t_4, Mt_2t_3t_2t_3t_2, Mt_4t_1t_4t_1t_4t_1t_3, Mt_3t_2t_3t_2t_3t_2t_3, Mt_1t_4t_1t_4t_1t_3, Mt_2t_3t_2t_3t_2t_3, Mt_3t_2t_3t_2t_4, Mt_3t_2t_3t_2, Mt_2t_4t_1t_3t_2t_4, Mt_2t_4t_1t_3t_2, Mt_3t_1t_4t_2t_3t_2t_3, Mt_4t_2t_3t_1t_4t_1t_3\}$ .

$$4. Bt_4 = \{Mt_1t_4t_1t_4t_1t_4t_2t_4, Mt_1t_4t_1t_4t_1, Mt_1t_4t_1t_4t_1t_3, Mt_4t_1t_4t_1t_4t_1t_4, \\ Mt_3t_2t_3t_2t_3t_2t_4, Mt_1t_4t_1t_4t_1t_4, Mt_2t_3t_2t_3t_2t_4, Mt_4t_1t_4t_1, Mt_4t_1t_4t_1t_3, \\ Mt_1t_3t_2t_4t_1, Mt_1t_3t_2t_4t_1t_3, Mt_3t_1t_4t_2t_3t_2t_4, Mt_4t_2t_3t_1t_4t_1t_4\}.$$

We can see clearly that  $\{Bt_1, Bt_2, Bt_3, Bt_4\} \cap B \neq \phi$  and  $\{Bt_1, Bt_2, Bt_3, Bt_4\} \neq B$ , so  $B$  has no possibilities for a block of any of the sizes.

Since  $G$  is transitive, and  $X$  has no a nontrivial block, then  $G$  acts primitively. (ii) To show  $G$  act faithful on  $X$ , we know that  $G$  acts on  $X$  implies there exist homomorphism  $f : G \rightarrow S_X$ , where  $|X| = 91$ .

By First Isomorphic Theorem,  $G/\ker f \cong f(G)$ . So, if  $\ker f = 1$  then  $G \cong f(G)$ . Only elements of  $M$  fix  $M$  that implies  $G_1$  is the point stabilizer of 1 in  $G$ ,  $G_1 = M$ .

$$\Rightarrow |G| = 91 \times |G_1| = 91 \times |M| = 91 \times 12 = 1092.$$

$$\Rightarrow |G| = 1092.$$

From Cayley Diagram,  $|G| = 1092$ .  $G$  will not be faithful on  $X$  if  $\ker f > 1$  and  $|G| > 1092$ . Thus,  $G$  acts faithfully on  $|X|$  since  $\ker f = 1$ . Thus,  $G$  acts faithfully and primitively on  $X$ .

**Step 2:  $G$  is perfect ( $G = G'$ )**

Note:  $G = \langle x, y, t \rangle = \langle t_1, t_2, t_3, t_4 \rangle$  and  $2^2 = \langle x, y \rangle = \langle (1, 2)(3, 4), (1, 3)(2, 4) \rangle$ ,  
 $xy = (1, 4)(2, 3)$

Let us take the relation  $t_1t_4t_1t_4t_1t_4t_3 = t_1t_3t_2t_4t_1t_4t_2t_3t_1t_4t_2t_3t_2$ .

Conjugate the both sides by  $t_1$  as  $(t_1t_4t_1t_4t_1t_4t_3)^{t_1} = (t_1t_3t_2t_4t_1t_4t_2t_3t_1t_4t_2t_3t_2)^{t_1}$

$$\Rightarrow (t_1^{-1})(t_1t_4t_1t_4t_1t_4t_3)(t_1) = (t_1^{-1})(t_1t_3t_2t_4t_1t_4t_2t_3t_1t_4t_2t_3t_2)(t_1).$$

$$\Rightarrow t_1t_1t_4t_1t_4t_1t_4t_3t_1 = t_1t_1t_3t_2t_4t_1t_4t_2t_3t_1t_4t_2t_3t_2t_1.$$

$$\Rightarrow t_4t_1t_4t_1t_4t_3t_1 = t_3t_2t_4t_1t_4t_2t_3t_1t_4t_2t_3t_2t_1.$$

$$\Rightarrow \underline{t_4t_1t_4t_1t_4t_3t_1} = t_3t_2t_4t_1t_4t_2t_3t_1t_4t_2t_3t_2t_1.$$

$$\Rightarrow [t_4, t_1]t_4t_3t_1 = t_3t_2t_4t_1t_4t_2t_3t_1t_4t_2t_3t_2t_1.$$

$$\Rightarrow [t_4, t_1] = t_3t_2t_4t_1t_4t_2t_3t_1t_4t_2t_3t_2t_1t_1t_3t_4.$$

$$\Rightarrow [t_4, t_1] = t_3t_2t_4t_1t_4t_2t_3t_1t_4t_2t_3t_2t_1t_1t_3t_4.$$

$$\Rightarrow [t_4, t_1] = t_3t_2t_4t_1t_4t_2t_3t_1t_4t_2t_3t_2t_3t_4.$$

$$\Rightarrow [t_4, t_1] = t_3t_2t_4t_1t_4t_2t_3t_1t_4t_2t_3t_2(1, 2)(3, 4)t_3.$$

$$\Rightarrow [t_4, t_1] = (1, 2)(3, 4)t_4t_1t_3t_2t_3t_1t_4t_2t_3t_1t_4t_1t_3.$$

$$\Rightarrow [t_4, t_1] = (1, 2)(3, 4)t_4t_1t_3t_2t_3t_1t_4t_2t_3t_1t_4t_1t_3.$$

$$\begin{aligned}
&\Rightarrow [t_4, t_1] = (1, 2)(3, 4)t_4t_1t_3t_2t_3t_1t_4t_2t_3t_1t_4(1, 3)(2, 4)t_1t_3t_1t_3t_1. \\
&\Rightarrow [t_4, t_1] = (1, 4)(2, 3)t_2t_3t_1t_4t_1t_3t_2t_4t_1t_3t_2t_1t_3t_1t_3t_1. \\
&\Rightarrow [t_4, t_1] = (1, 4)(2, 3)t_2t_3t_1t_4t_1t_3t_2t_4t_1t_3t_2t_1t_3t_1t_3t_1. \\
&\Rightarrow [t_4, t_1]t_1t_3t_1t_3 = (1, 4)(2, 3)t_2t_3t_1t_4t_1t_3t_2t_4t_1t_3t_2t_1. \\
&\Rightarrow [t_4, t_1][t_1, t_3] = (1, 4)(2, 3)t_2t_3t_1t_4t_1t_3t_2t_4t_1t_3(1, 2)(3, 4)t_2. \\
&\Rightarrow [t_4, t_1][t_1, t_3] = (1, 3)(2, 4)t_1t_4t_2t_3t_2t_4t_1t_3t_2t_4t_2. \\
&\Rightarrow [t_4, t_1][t_1, t_3] = (1, 3)(2, 4)t_1t_4t_2t_3t_2t_4t_1t_3t_2t_4t_2. \\
&\Rightarrow [t_4, t_1][t_1, t_3] = (1, 3)(2, 4)t_1t_4t_2t_3t_2t_4t_1t_3(1, 3)(2, 4)t_2t_4t_2t_4. \\
&\Rightarrow [t_4, t_1][t_1, t_3] = t_3t_2t_4t_1t_4t_2t_3t_1t_2t_4t_2t_4. \\
&\Rightarrow [t_4, t_1][t_1, t_3] = t_3t_2t_4t_1t_4t_2t_3t_1t_2t_4t_2t_4. \\
&\Rightarrow [t_4, t_1][t_1, t_3]t_4t_2t_4t_2 = t_3t_2t_4t_1t_4t_2t_3t_1. \\
&\Rightarrow [t_4, t_1][t_1, t_3][t_4, t_2] = t_3t_2t_4(1, 2)(3, 4)t_2t_3t_2t_1t_3t_1. \\
&\Rightarrow [t_4, t_1][t_1, t_3][t_4, t_2] = (1, 2)(3, 4)t_4t_1t_3t_2t_3t_2t_1t_3t_1. \\
&\Rightarrow [t_4, t_1][t_1, t_3][t_4, t_2] = (1, 2)(3, 4)t_4t_1t_3t_2t_3t_2t_1t_3t_1. \\
&\Rightarrow [t_4, t_1][t_1, t_3][t_4, t_2] = (1, 2)(3, 4)t_4t_1t_3t_2t_3t_2(1, 3)(2, 4)t_1t_3t_1t_3. \\
&\Rightarrow [t_4, t_1][t_1, t_3][t_4, t_2] = (1, 4)(2, 3)t_2t_3t_1t_4t_1t_4t_1t_3t_1t_3. \\
&\Rightarrow [t_4, t_1][t_1, t_3][t_4, t_2] = (1, 4)(2, 3)t_2t_3t_1t_4t_1t_3t_1t_3. \\
&\Rightarrow [t_4, t_1][t_1, t_3][t_4, t_2]t_3t_1t_3t_1 = (1, 4)(2, 3)t_2t_3t_1t_4t_1t_4. \\
&\Rightarrow [t_4, t_1][t_1, t_3][t_4, t_2][t_3, t_1]t_4t_1t_4t_1 = (1, 4)(2, 3)t_2t_3. \\
&\Rightarrow [t_4, t_1][t_1, t_3][t_4, t_2][t_3, t_1][t_4, t_1] = t_2t_3t_2t_3t_2t_3t_2t_3t_2t_3t_2. \\
&\Rightarrow [t_4, t_1][t_1, t_3][t_4, t_2][t_3, t_1][t_4, t_1] = t_2t_3t_2t_3t_2t_3t_2t_3t_2t_3t_2. \\
&\Rightarrow [t_4, t_1][t_1, t_3][t_4, t_2][t_3, t_1][t_4, t_1]t_2t_3t_2t_3t_2t_3t_2t_3 = t_2t_3t_2. \\
&\Rightarrow [t_4, t_1][t_1, t_3][t_4, t_2][t_3, t_1][t_4, t_1][t_2, t_3][t_2, t_3] = t_3t_3t_2t_3t_2. \\
&\Rightarrow [t_4, t_1][t_1, t_3][t_4, t_2][t_3, t_1][t_4, t_1][t_2, t_3][t_2, t_3] = t_3t_3t_2t_3t_2. \\
&\Rightarrow [t_4, t_1][t_1, t_3][t_4, t_2][t_3, t_1][t_4, t_1][t_2, t_3][t_2, t_3]t_2t_3t_2t_3 = t_3. \\
&\Rightarrow [t_4, t_1][t_1, t_3][t_4, t_2][t_3, t_1][t_4, t_1][t_2, t_3][t_2, t_3] = t_3. \\
&\Rightarrow [t_4, t_1][t_1, t_3][t_4, t_2][t_3, t_1][t_4, t_1][t_2, t_3][t_2, t_3] \in G'.
\end{aligned}$$

We see the left side is belong to  $G'$ , so the right side is belong to  $G'$ .

$\Rightarrow t_3 \in G'$ , then we conjugate  $t_3$  by  $x$ ,  $y$ , and  $xy$  to get  $t_4$ ,  $t_1$ , and  $t_2$  respectively. So,  $G' \geq \langle t_1, t_2, t_3, t_4 \rangle$ , and we know that  $G = \langle t_1, t_2, t_3, t_4 \rangle$ . So,  $G' \geq \langle t_1, t_2, t_3, t_4 \rangle = G$ , and  $G' \subseteq G$   
 $\Rightarrow G' = G$ . Thus,  $G$  is perfect.

**Step 3: Show there exists a normal abelian subgroup  $K \leq G$  such that  $K \triangleleft G_x$  and the conjugates of  $K$  generate  $G$ .**

We now that  $G_1 = N = 2^2$ , and  $N$  is a normal abelian subgroup of  $G$  has center 1. So,  $K = N = (1, 2)(3, 4), (1, 3)(2, 4)$ .

Let take  $(1, 4)(2, 3) \in K$ , and let use the relation  $t_1 t_4 t_1 t_3 t_1 = (1, 4)(2, 3) t_4 t_2 t_3 t_1 t_3$ .

$$\Rightarrow t_1 t_4 t_1 t_3 t_1 t_3 t_1 t_3 t_2 t_4 = (1, 4)(2, 3).$$

Since  $t_1 t_4 t_1 t_3 t_1 t_3 t_1 t_3 t_2 t_4 \in K$  and  $t_4 \in G$

$$\text{We have } (t_1 t_4 t_1 t_3 t_1 t_3 t_1 t_3 t_2 t_4)^{t_4} \in K^G$$

$$\Rightarrow (t_4)^{-1} (t_1 t_4 t_1 t_3 t_1 t_3 t_1 t_3 t_2 t_4) (t_4) \in K^G$$

$$\Rightarrow t_4 t_1 t_4 t_1 t_3 t_1 t_3 t_1 t_3 t_2 t_4 t_4 \in K^G$$

$$\Rightarrow t_4 t_1 t_4 t_1 t_3 t_1 t_3 t_1 t_3 t_2 \in K^G$$

$$\Rightarrow t_4 t_1 t_4 t_1 t_3 t_1 t_3 t_1 t_3 t_2 \in K^G$$

$$\Rightarrow t_4 t_1 t_4 (1, 3)(2, 4) t_1 t_2 \in K^G$$

$$\Rightarrow (1, 3)(2, 4) t_2 t_3 t_2 t_1 t_2 \in K^G$$

$$\Rightarrow (1, 3)(2, 4) t_2 t_3 t_2 t_1 t_2 \in K^G$$

$$\Rightarrow (1, 4)(2, 3) t_1 t_4 \in K^G$$

$$\Rightarrow (1, 4)(2, 3) t_1 t_4 \in K^G$$

$$\Rightarrow t_1 t_4 t_1 t_4 t_1 t_4 t_1 t_4 t_1 t_4 t_1 \in K^G$$

$$\Rightarrow (t_1 t_4 t_1 t_4 t_1 t_4 t_1 t_4 t_1)^{(t_1 t_4 t_1 t_4 t_1)} \in K^G$$

$$\Rightarrow (t_1 t_4 t_1 t_4 t_1)^{-1} (t_1 t_4 t_1 t_4 t_1 t_4 t_1 t_4 t_1) (t_1 t_4 t_1 t_4 t_1) \in K^G$$

$$\Rightarrow t_1 t_4 t_1 t_4 t_1 t_1 t_4 t_1 t_4 t_1 t_4 t_1 t_4 t_1 t_4 t_1 t_1 t_4 t_1 t_4 t_1 \in K^G$$

$$\Rightarrow t_4 \in K^G$$

$$\Rightarrow K^G \supseteq \{t_4, t_4^x, t_4^y, t_4^{xy}\}$$

$$\Rightarrow K^G \supseteq \{t_4, t_3, t_2, t_1\} = \langle t_4, t_3, t_2, t_1 \rangle = G$$

$$\Rightarrow G = K^G.$$

From the steps (1), (2), and (3) and by Iwasawa's Lemma  $G$  is simple group.

### 7.3 Construction of $S_6$

We take the progenitor  $2^{*5} : S_5$ , where  $2^{*5}$  is the free product of 5 copies of the cyclic groups of order 2, and  $S_5$  is the group of automorphisms of  $2^{*5}$  which permutes the five symmetric generators by conjugation and factor it by the relation  $(012) = t_0 t_1 t_2 t_0$ . The double coset enumeration partitions the image of the group  $G$  as a union double cosets  $NgN$  where  $g \in 2^{*5} : S_5$ . Thus, we can find the set of elements  $g_1, g_2, \dots$  of  $G$  such that  $G = Ng_1N \cup Ng_2N \cup \dots$ , and for each  $i$ , we have  $g_i = p_i w_i$ , where  $p_i \in N$ , and  $w_i$  is a word in the  $t_i$ 's. Hence, the double coset decomposition is given by

$$G = Nw_1N \cup Nw_2N \cup Nw_3N \cup \dots,$$

where  $w_1 = e$  (the identity). We perform a double coset enumeration of the group  $\frac{2^{*5} : S_5}{[(012) = tt^x t^{x^2} t]}$  over  $S_5$ . We will show

$$G = \frac{2^{*5} : S_5}{[(012) = tt^x t^{x^2} t]} \cong S_6 \times 2.$$

A symmetric presentation of the progenitor  $2^{*5} : S_5$  is given by:

$$2^{*5} : S_5 \cong$$

$$\langle x, y, t \mid x^5, y^2, (x^{-1}y)^4, (xyx^{-2}yx)^2, t^2, (t, y), \\ (t, yx^2yx^2yx^{-1}), (t, x^{-2}yx^2), (t, yx^2yx^2yx) \rangle;$$

$G$  factored by  $[(012) = tt^x t^{x^2} t]$ .  $N \cong S_5 = \langle x, y \rangle$ , where  $x \sim (0, 1, 2, 3, 4)$  and  $y \sim (1, 2)$  and  $t = t_5 = t_0$ .

**Using computer-based program - MAGMA :**

1. The order of the group,  $|G|$  is equal to 120.
2. There are 4 double coset in this double coset enumeration of  $G$  over  $S_5$ .

#### Relations

We see that

$$(012) = t_0 t_1 t_2 t_0 \Rightarrow (012)t_0 t_2 = t_0 t_1 \Rightarrow Nt_0 t_2 = Nt_0 t_1.$$

Moreover, if we conjugate the previous relation by all elements in  $S_5$ . Therefore, the different cosets are:

$$(1) ((012)t_0 t_2 = t_0 t_1)^e \Rightarrow (012)t_0 t_2 = t_0 t_1$$

- (2)  $((012)t_0t_2 = t_0t_1)^{(0,1,2,3,4)} \Rightarrow (123)t_1t_3 = t_1t_2$   
(3)  $((012)t_0t_2 = t_0t_1)^{(0,1)} \Rightarrow (102)t_1t_2 = t_1t_0$   
(4)  $((012)t_0t_2 = t_0t_1)^{(1,0)(2,4,3)} \Rightarrow (104)t_1t_4 = t_1t_0$   
(5)  $((012)t_0t_2 = t_0t_1)^{(1,2)(3,0)} \Rightarrow (321)t_3t_1 = t_3t_2$   
:  
:  
(120)  $((012)t_0t_2 = t_0t_1)^{(2,0)(3,4)} \Rightarrow (210)t_2t_0 = t_2t_1$

$\Rightarrow 01 \approx 02 \approx 03 \approx 04, 10 \approx 12 \approx 13 \approx 14, 20 \approx 21 \approx 23 \approx 24, 30 \approx 31 \approx 32 \approx 34,$  and  
 $40 \approx 41 \approx 42 \approx 43.$

### Double Coset Enumeration of $G$ over $S_5$ : Double Coset $[*]$ :

We start with the double coset  $NeN$ , where  $e$  is word of length zero, denoted by  $[*]$ . We have

$$NeN = \{Nen : n \in N\} = \{Ne\} = \{N\}$$

So, the double coset  $NeN$  consists of the single coset  $N$ . Thus,  $\frac{|N|}{|N|} = \frac{120}{120} = 1$ .

Note, since  $N$  is transitive on  $\{0, 1, 2, 3, 4\}$ , we take a representative coset  $N$  from  $[*]$  and a representative from  $\{0, 1, 2, 3, 4\}$  and determine the double coset to which  $Nt_i$  belongs, where  $i \in \{0, 1, 2, 3, 4\}$ . We consider  $i = 0$ , so  $Nt_0$  is a representative coset, and hence we will have a new double coset  $Nt_0N$  which can denoted by  $[0]$ . There will be three possible  $t_i$ s in  $[*]$  that will advance to the next double coset  $[0]$ .

### Word of Length One $[0]$ :

we consider the double coset  $NwN$ , where  $w$  is a word of length one.  $Nt_0N = \{Nt_0^n | n \in N\}$ , or  $[0]$ . We need to find the point stabilizer of 0. So,  $Nt_0N = [0] = \{Nt_0^n | n \in N\} = \{Nt_0N, Nt_1N, Nt_2N, Nt_3N, Nt_4N\}$ . Since, the point stabilizer of 0 in the subgroup  $N$  is the permutations in  $N$  that fixes 0 and permute the rest of the elements in the set  $\{1, 2, 3, 4\}$ . **Note:**  $N^{(0)} = \{n \in N | (t_0)^n = t_0\} \geq \langle (1, 2), (2, 3), (1, 4, 3, 2), (3, 4) \rangle$ .

Since  $|N^{(0)}| = 24$  then the number of single cosets in  $[0]$  is  $\frac{|N|}{|N^{(0)}|} = \frac{120}{24} = 5$ .

Now, the orbits of  $N^{(0)}$  on  $\{0, 1, 2, 3, 4\}$  are  $\{0\}$  and  $\{1, 2, 3, 4\}$ . We choose a representative from each orbit,  $\{0\}$  and  $\{1, 2, 3, 4\}$ . If we choose  $t_0$  from the orbit  $\{0\}$  and choose  $t_1$  from the orbit  $\{1, 2, 3, 4\}$ , then we notice the following

- $Nt_0 \cdot t_0 = Nt_0^2 = N \in [*]$ . This will go back to  $[*]$ . This is denoted by number 1 in Cayley diagram (to the left of the circle containing 3).
- $Nt_0 \cdot t_1 = Nt_0t_1 \in [01]$ . This is a new double coset, which will extend the Cayley graph from  $[0]$  to  $[01]$ . Since there are 4 elements in this orbit, then there will be 4  $t_i$ s that take  $[0]$  to  $[01]$ .

$$Nt_0N = \{N(t_0)^n | n \in N\} = \{Nt_0, Nt_1, Nt_2, Nt_3, Nt_4\}.$$

### Word of Length Two $[01]$ :

We are at a new double coset  $[01]$ ,  $Nt_0t_1N = \{N(t_0t_1)^n | n \in N\}$ . Now, to determine all the single cosets of this double cosets, we need to determine the point stabilizer  $N^{01}$ , this means finding the set of elements that fix 0 and 1 in  $N$  and permute the rest of the elements in the set  $\{2, 3, 4\}$ . Now, using our relation  $(0, 1, 2)t_0t_2 = t_0t_1$ .

$$\Rightarrow N^{(01)} \geq \langle (1, 3, 4), (1, 2, 4), (1, 3)(2, 4), (1, 4)(2, 3), (1, 2)(3, 4), (1, 3, 2),$$

$$(1, 2, 3), (1, 4, 2), (2, 4), (1, 2, 4, 3), (1, 2, 3, 4), (1, 4), (1, 3, 2, 4), (3, 4),$$

$$(1, 4, 3), (1, 4, 2, 3), (1, 2), (1, 3), (1, 4, 3, 2), (1, 3, 4, 2) \rangle. \text{ Thus, } |N^{(01)}| = 24.$$

So, the number of single cosets in  $[01]$  is  $\frac{|N|}{|N^{(01)}|} = \frac{120}{24} = 5$ . In order to find these 5 single cosets, we need to determine the transversals (right coset representatives) of  $N^{(01)}$ . The 5 single distinct cosets of the double coset  $[01]$  are:  $\{Nt_0t_1, Nt_1t_2, Nt_2t_3, Nt_3t_2, Nt_4t_5\}$ . Now, we need to find the orbits of  $N^{(01)}$  to advance to the next double coset. The orbits of  $N^{(01)}$  on  $\{0, 1, 2, 3, 4\}$  are:  $\{0\}$ , and  $\{1, 2, 3, 4\}$ . Considering a representative from each orbit of  $N^{(01)}$ , we will choose the following representative from each orbit:  $t_0$  from  $\{0\}$  and  $t_1$  from  $\{1, 2, 3, 4\}$ . Multiply each representative with  $Nt_0t_1$  :

- $Nt_0t_1 \cdot t_0 = Nt_0t_1t_0 \in [010]$ . This is a new double coset, which extends our graph from  $[01]$  to  $[010]$ . Since there is 1 element in this orbit, there is one  $t_i$  that take  $[01]$  to  $[010]$ .
- $Nt_0t_1 \cdot t_1 \in [0]$ . This will go back to  $[0]$ . Since there is 4 element in this orbit, there are 4  $t'_i$ s that take  $[01]$  to  $[0]$ .

### Word of Length Three $[010]$ :

Again we need to find the point stabilizer of 0 , 1, and 0. This is denoted by  $N^{010}$ . Therefore, we need to find the permutations in  $N$  that fixes 0, 1 and 0. The coset

stabilizer of the coset  $t_0t_1t_0$ ,  $N^{(010)} \geq N^{010}$ . Using the relation  $(012)t_0t_2 = t_0t_1$ , we multiply both sides by  $t_0$  to get  $(0, 1, 2)t_0t_2t_0 = t_0t_1t_0$ .

$\Rightarrow N^{(010)} \geq \langle (0, 1, 2, 3, 4), (1, 2) \rangle \cong S_6$ . Hence,  $|N^{(010)}| = N = 120$ ,

so  $\frac{|N|}{|N^{(010)}|} = \frac{120}{120} = 1$ . Therefore, there are 1 distinct coset representative. There is single distinct coset of the double coset  $[010]$  are:  $\{Nt_0t_1t_0\}$ . The transversal of  $N^{(010)}$  in  $N$  is:  $Nt_0t_1t_0$ , and the orbit of  $N^{(010)}$  in  $\{0, 1, 2, 3, 4\}$  is  $\{0, 1, 2, 3, 4\}$ .

**Conclusion:**

The double coset enumeration gives that

$$G = N \cup Nt_0 \cup Nt_1 \cup Nt_2 \cup Nt_3 \cup Nt_4 \cup Nt_0t_1 \cup Nt_1t_0 \cup Nt_2t_0 \cup Nt_3t_0 \cup Nt_4t_0 \cup Nt_0t_1t_0.$$

$$|G| \leq (|N| + \frac{|N|}{|N^{(0)}|} + \frac{|N|}{|N^{(01)}|} + \frac{|N|}{|N^{(010)}|}) \times |N|$$

$$= (1 + 5 + 5 + 1) \times 120$$

$$= (12 \times 120) = 1440. \text{ A Cayley diagram of } S_6 \times 2 \text{ over } S_5 \text{ is given below.}$$

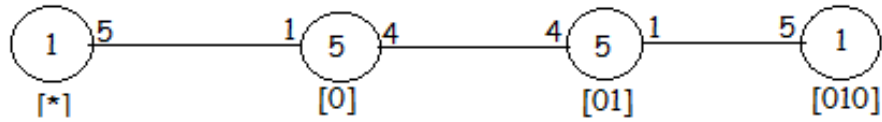

Figure 7.2: Cayley Diagram for  $S_6 \times 2$  Over  $S_5$



To find the permutation representation of  $x$ ,  $y$ , and  $t_0$  we label all the right cosets and conjugate them by  $x$  and  $y$  and multiply them by  $t_0$  as the following table,

Table 7.1: Permutation Representation of  $x$ ,  $y$ , and  $t_0$

Cosets	$x \sim (0, 1, 2, 3, 4)$	$y \sim (1, 2)$	$t_0$
1. $N$	1. $N$	1. $N$	2. $Nt_0$
2. $Nt_0$	3. $Nt_1$	2. $Nt_0$	1. $N$
3. $Nt_1$	4. $Nt_2$	4. $Nt_2$	8. $Nt_1t_0$
4. $Nt_2$	5. $Nt_3$	3. $Nt_1$	9. $Nt_2t_0$
5. $Nt_3$	6. $Nt_4$	5. $Nt_3$	10. $Nt_3t_0$
6. $Nt_4$	2. $Nt_0$	6. $Nt_4$	11. $Nt_4t_0$
7. $Nt_0t_1$	8. $Nt_1t_0$	7. $Nt_0t_1$	12. $Nt_0t_1t_0$
8. $Nt_1t_0$	9. $Nt_2t_0$	9. $Nt_2t_0$	3. $Nt_1$
9. $Nt_2t_0$	10. $Nt_3t_0$	8. $Nt_1t_0$	4. $Nt_2$
10. $Nt_3t_0$	11. $Nt_4t_0$	10. $Nt_3t_0$	5. $Nt_3$
11. $Nt_4t_0$	7. $Nt_0t_1$	11. $Nt_4t_0$	6. $Nt_4$
12. $Nt_0t_1t_0$	12. $Nt_0t_1t_0$	12. $Nt_0t_1t_0$	7. $Nt_0t_1$

$$\varphi(x) = (2, 3, 4, 5, 6)(7, 8, 9, 10, 11).$$

$$\varphi(y) = (3, 4)(8, 9).$$

$$\varphi(t) = (1, 2)(3, 8)(4, 9)(5, 10)(6, 11)(7, 12).$$

Then, we note that  $G = \frac{2^{*5} : S_5}{[(012) = tt^xtx^2t]}$  acts on the twelve cosets above and the actions of  $t$ ,  $x$ , and  $y$  on the twelve cosets is well-defined. Thus, we have a homomorphism  $\phi : G \rightarrow S_{12}$ . Then  $\phi(G) = \langle \varphi(x), \varphi(y), \varphi(t) \rangle$ ; That is a homomorphic image of  $2^{*5} : S_5$  if the following proved,

(1)  $\phi(N) \cong S_5$ .

We have  $\phi(N) = \langle \varphi(x), \varphi(y) \rangle = \langle (2, 3, 4, 5, 6)(7, 8, 9, 10, 11), (3, 4)(8, 9) \rangle \cong S_5$  since  $S_5 = \{x, y|x^5, y^2, (x * y)^4, \dots\}$ .

$\Rightarrow |(2, 3, 4, 5, 6)(7, 8, 9, 10, 11) * (3, 4)(8, 9)| = |(2, 4, 5, 6)(7, 9, 10, 11)| = 4$  which is the first case proved.

(2)  $\varphi(t)$  has 5 conjugates acts under conjugation by  $\phi(N)$ .

To find  $\varphi(t)^{\phi(N)}$  we will conjugate  $\varphi(t)$  by  $x$ ,  $x^2$ ,  $x^3$ ,  $x^4$ , and  $x^5$  respectively.

- $\varphi(t)^x = ((1, 2)(3, 8)(4, 9)(5, 10)(6, 11), (7, 12))^{(2,3,4,5,6)(7,8,9,10,11)} = (1, 3)(2, 7)(4, 9)(5, 10)(6, 11)(8, 12) = t_1$ .
- $\varphi(t)^{x^2} = ((1, 2)(3, 8)(4, 9)(5, 10)(6, 11), (7, 12))^{(2,4,6,3,5)(7,9,11,8,10)} =$

$$(1, 4)(2, 7)(3, 8)(5, 10)(6, 11)(9, 12) = t_2.$$

$$\bullet \varphi(t)^{x^3} = ((1, 2)(3, 8)(4, 9)(5, 10)(6, 11), (7, 12))^{(2,5,3,6,4)(7,10,8,11,9)} = (1, 5)(2, 7)(3, 8)(4, 9)(6, 11)(10, 12) = t_3.$$

$$\bullet \varphi(t)^{x^4} = ((1, 2)(3, 8)(4, 9)(5, 10)(6, 11), (7, 12))^{(2,6,5,4,3)(7,11,10,9,8)} = (1, 6)(2, 7)(3, 8)(4, 9)(5, 10)(11, 12) = t_4.$$

$$\bullet \varphi(t)^{x^5} = ((1, 2)(3, 8)(4, 9)(5, 10)(6, 11), (7, 12))^e = ((1, 2)(3, 8)(4, 9)(5, 10)(6, 11), (7, 12)) = t_0.$$

So,  $\varphi(t)^{\phi(N)} = \{t_0, t_1, t_2, t_3, t_4\}$ .

(3)  $\phi(N)$  acts as  $S_5$  on the 5 conjugates of the  $\varphi(t)$  by conjugates.

- The 5  $t'_s$ s conjugate by  $x = (0, 1, 2, 3, 4)$  as the following,

$$- t_0^x = t_1.$$

$$- t_1^x = t_2.$$

$$- t_2^x = t_3.$$

$$- t_3^x = t_4.$$

$$- t_4^x = t_0.$$

$$\Rightarrow \varphi(x) = (t_0, t_1, t_2, t_3, t_4).$$

- The 5  $t'_s$ s conjugate by  $y = (1, 2)$  as the following,

$$- t_0^y = t_0.$$

$$- t_1^y = t_2.$$

$$- t_2^y = t_1.$$

$$- t_3^y = t_3.$$

$$- t_4^y = t_4.$$

$$\Rightarrow \varphi(y) = (t_1, t_2).$$

(4) Now, to check if  $\varphi(y*x*y*x^{-1}) = \varphi(t_0t_1t_2t_0)$  we work in each side separately then compare them.

$$L.H.S. = \varphi(y * x * y * x^{-1})$$

$$\begin{aligned}
&= (3, 4)(8, 9) * (2, 3, 4, 5, 6)(7, 8, 9, 10, 11) * (3, 4)(8, 9) * \\
&((2, 3, 4, 5, 6)(7, 8, 9, 10, 11))^{-1} \\
&= (3, 4)(8, 9) * (2, 3, 4, 5, 6)(7, 8, 9, 10, 11) * (3, 4)(8, 9) * \\
&(2, 6, 5, 4, 3)(7, 11, 10, 9, 8) \\
&= (2, 3, 4)(7, 8, 9).
\end{aligned}$$

$$R.H.S. = \varphi(t_0 t_1 t_2 t_0)$$

$$\begin{aligned}
&= (1, 2)(3, 8)(4, 9)(5, 10)(6, 11)(7, 12) * (1, 3)(2, 7)(4, 9)(5, 10)(6, 11)(8, 12) \\
&* (1, 4)(2, 7)(3, 8)(5, 10)(6, 11)(9, 12) * (1, 2)(3, 8)(4, 9)(5, 10)(6, 11)(7, 12) \\
&= (2, 3, 4)(7, 8, 9)
\end{aligned}$$

So, the L.H.S. = R.H.S. that imply  $\phi : G \xrightarrow{Homom.} S_{12}$

, so that  $\phi(G) = \langle \varphi(x), \varphi(y), \varphi(t) \rangle$ .

We know  $G/\ker\phi \cong \phi(G) \Rightarrow |G| = |\ker\phi| \cdot |\phi(G)|$ . By using the Cayley diagram,  $|G| \leq 1440 \rightarrow (1)$ .

By using MAGMA  $|\phi(G)| = |\langle \varphi(x), \varphi(y), \varphi(t) \rangle| = 1440$ .

$$\Rightarrow |G| = |\ker\phi|1440.$$

$$\Rightarrow |G| \geq 1440 \rightarrow (2).$$

from (1) and (2) we have  $|G| = 1440$ .

$$G = \frac{2^{*5} : S_5}{(012) = t_0 t_1 t_2 t_0} \cong S_6 \times Z(G)$$

We showed if  $\varphi((012)) = \varphi(t_0 t_1 t_2 t_0)$  then  $\langle \varphi(x), \varphi(y), \varphi(t_0) \rangle$  is homomorphic image of  $G$ .

By (1), (2), (3), and (4) we have that  $\langle \varphi(x), \varphi(y), \varphi(t_0) \rangle$  is a homomorphic image of  $2^{*5} : S_5$ .

Suppose we have the  $G$ -set call it  $X$  and we have the subset  $B$  of  $X$ , then to show  $G$  is primitive we will show that  $G$  is transitive and has no nontrivial blocks of  $X$  under the action  $G$ .

By using the Cayley diagram of  $G$ , we have  $X = \{N, Nt_0, Nt_1, Nt_2, Nt_3, Nt_4, Nt_0t_1, Nt_1t_0, Nt_2t_0, Nt_3t_0, Nt_4t_0, Nt_0t_1t_0\}$ ,  $\Rightarrow |X| = 12$ .

We know  $X$  is transitive  $G$ -set by using the diagram (since any group  $G$  represented by a Cayley diagram is transitive). Next, we note that if  $B$  is a block of  $X$  under the action of  $G$  then  $|B|$  has to divide  $|X|$ .

So possible orders of  $B$  are positive divisors of 12. Thus,  $|B| = 1, 2, 3, 4, 6, 12$ .

We will discard the orders 1 and 12 because those are blocks. Now, a nontrivial block must be of size 2, 3, 4, or 6. Let  $B$  be a nontrivial block and  $N \in B$ .  $X$  has a system of blocks of impermutivity of size 2. That imply the center element is  $(1, 12)(2, 7)(3, 8)(4, 9)(5, 10)(6, 11)$ , to prove the center;

Suppose  $nt_0t_1t_0$  is the center's element, where  $n \in N$ , then factor by the center  
 $nt_0t_1t_0 = 1 \Rightarrow n^{-1} = t_0t_1t_0$ .

Find the action of  $n$  on  $Nt_0, Nt_1, Nt_2, Nt_3$  and  $Nt_4$ .

$$\begin{aligned}
(1) \quad & Nt_0^{t_0t_1t_0} = N(t_0t_1t_0)^{-1}t_0(t_0t_1t_0) = Nt_0t_1t_0t_0t_0t_1t_0 = Nt_0t_1t_0t_1t_0 \\
& = Nt_0t_1\underline{t_0t_1t_0} = Nt_0t_1t_1t_0t_1 = Nt_1. \\
(2) \quad & Nt_1^{t_0t_1t_0} = N(t_0t_1t_0)^{-1}t_1(t_0t_1t_0) = Nt_0t_1t_0t_1\underline{t_0t_1t_0} = Nt_0t_1t_0t_1t_1t_0t_1 = Nt_0. \\
(3) \quad & Nt_2^{t_0t_1t_0} = N(t_0t_1t_0)^{-1}t_2(t_0t_1t_0) = N\underline{t_0t_1t_0}t_2t_0t_1t_0 = Nt_0t_2t_0t_2\underline{t_0t_1t_0} \\
& = Nt_0t_2t_0t_2(012)t_0t_2t_0 = Nt_1t_0t_1t_0t_0t_2t_0 = Nt_1t_0t_1t_2t_0 = Nt_1\underline{t_0t_1t_2t_0} \\
& = Nt_1(012) = Nt_2. \\
(4) \quad & Nt_3^{t_0t_1t_0} = N(t_0t_1t_0)^{-1}t_3(t_0t_1t_0) = Nt_0t_1\underline{t_0t_3t_0}t_1t_0 \\
& = Nt_0t_1(031)t_0t_1t_0t_1t_0 = Nt_3t_0t_0t_1t_0t_1t_0 = Nt_3t_1t_0t_1t_0 = Nt_3t_1\underline{t_0t_1t_0} \\
& = Nt_3t_1(012)t_0t_2t_0 = Nt_3t_2t_0\underline{t_2t_0} = Nt_3t_2t_0(210)t_2t_1 = Nt_3t_1t_2t_2t_1 = Nt_3. \\
(5) \quad & Nt_4^{t_0t_1t_0} = N(t_0t_1t_0)^{-1}t_4(t_0t_1t_0) = Nt_0t_1t_0\underline{t_4t_0}t_1t_0 \\
& = Nt_0t_1(024)t_0t_2t_0t_1t_0 = Nt_2t_1t_0\underline{t_2t_0}t_1t_0 = Nt_2t_1(012)t_0t_1t_0t_1t_0 \\
& = N\underline{t_0t_2t_0}t_1t_0t_1t_0 = Nt_0t_1t_0t_1t_0t_1t_0 = Nt_0\underline{t_1t_0}t_1t_0t_1t_0 \\
& = Nt_0(140)t_1t_4t_1t_0t_1t_0 = Nt_1t_1t_4t_1t_0t_1t_0 = Nt_4\underline{t_1t_0}t_1t_0 = Nt_4(140)t_1t_4t_1t_0 \\
& = Nt_0t_1t_4t_1t_0 = Nt_0t_1t_4\underline{t_1t_0} = Nt_0t_1t_4(140)t_1t_4 = Nt_1t_4t_0t_1t_4 \\
& = Nt_1t_4t_0(142)t_1t_2 = Nt_4t_2t_0t_1t_2 = Nt_4t_2\underline{t_0t_1t_2} = Nt_4t_2(012)t_0 \\
& = Nt_4t_0t_0 = Nt_4.
\end{aligned}$$

$$\Rightarrow t_0t_1t_0 = (0, 1)$$

$$\Rightarrow n^{-1} = (0, 1) \Rightarrow (n^{-1})^{-1} = (0, 1)^{-1} \Rightarrow n = (0, 1) \Rightarrow n = x * y * x^{-1}.$$

So, the center call it  $Z(G)$  is generated by  $\langle x * y * x^{-1}t_0t_1t_0 \rangle$ .

$$\Rightarrow \frac{2^{*5} : S_5}{((012) = t_0t_1t_2t_0), (x * y * x^{-1}t_0t_1t_0)} \cong S_6 \times 2.$$

Thus, the new diagram of this group will decrease to be as the following;

We do not need the old relation since we can replace it by the new relation.

We will start with the relation  $(x * y * x^{-1})t_0t_1t_0 = 1$  to find the relation  $(012)t_0t_2t_1t_0 = 1$ ;

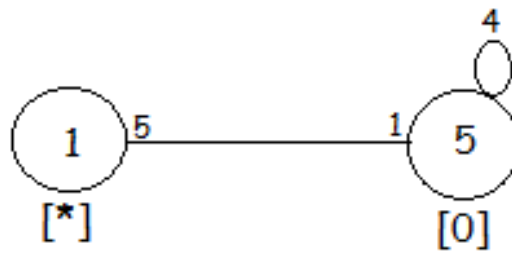
Figure 7.3: Cayley Diagram for  $S_6$  Over  $S_5$ 

$$\begin{aligned}
 &(x * y * x^{-1})t_0t_1t_0 = 1 \\
 \Rightarrow &(01)t_0 = t_0t_1 \\
 \Rightarrow &(01)t_0t_2 = t_0t_1t_2 \\
 \Rightarrow &(01)t_0t_2t_0 = t_0t_1t_2t_0 \\
 \Rightarrow &(01)\underline{t_0t_2t_0} = t_0t_1t_2t_0 \\
 \Rightarrow &(01)(021)t_0t_1t_0 = t_0t_1t_2t_0 \\
 \Rightarrow &(12)\underline{t_0t_1t_0} = t_0t_1t_2t_0 \\
 \Rightarrow &(12)(01) = t_0t_1t_2t_0 \\
 \Rightarrow &(012) = t_0t_1t_2t_0.
 \end{aligned}$$

Finally;

$$G = \frac{2^{*5} : S_5}{(01) = t_0t_1t_0} \cong S_6$$

## 7.4 How To Write The Elements of The Group:

We know each group define by elements and there are two ways to write the elements of  $G$  in Symmetric or Permutation forms since  $G$  as the following form;

$$G = \frac{2^{*n} : S_n}{((012) = t_0 t_1 t_2 t_0)}$$

### 1. Symmetric To Permutation:

Every element of  $G$  is of the form  $nw$  where  $n$  is a permutation of  $S_n$  on  $n$  letters and  $w$  is a word of length at most 3.

**Example 7.7.** From the last group we work in  $G = \frac{2^{*5} : S_5}{((012) = t_0 t_1 t_2 t_0)}$ . In this example  $n$  is the permutation of  $S_5$  on 5 letters and  $w$  is a word of length at most 3. We write the elements of  $G$  in the Symmetric form,

e	(0, 1, 2, 3, 4)	(1, 2)	...	(1,2)(3,0)
$t_0$	(0, 1, 2, 3, 4) $t_0$	(1, 2) $t_0$	...	(1, 2)(3, 0) $t_0$
$t_1$	(0, 1, 2, 3, 4) $t_1$	(1, 2) $t_1$	...	(1, 2)(3, 0) $t_1$
:	:	:	...	:
:	:	:	...	:
$t_0 t_1 t_0$	(0, 1, 2, 3, 4) $t_0 t_1 t_0$	(1, 2) $t_0 t_1 t_0$	...	(1, 2)(3, 0) $t_0 t_1 t_0$

Convert we take  $(0, 1, 2, 3, 4)t_0 t_1$  from the Symmetric form and we want to find the Permutation form.

$$\Rightarrow (0, 1, 2, 3, 4)t_0 t_1 = (1, 7)(2, 12)(3, 4, 5, 6)(8, 9, 10, 11)$$

(0, 1, 2, 3, 4)	$t_0$	$t_1$
$x$	$t_0$	$t_1$
↓	↓	↓
$\varphi(x)$	$\varphi(t_0)$	$\varphi(t_1)$
$\varphi(x)$	$\varphi(t_0)$	$(\varphi(t_0))^{\varphi(x)}$
(2,3,4,5,6)(7,8,9,10,11)	(1,2)(3,8)(4,9)(5,10)(6,11)(7,12)	(1,3)(2,7)(4,9)(5,10)(6,11)(8,12)

### 2. Permutation To Symmetric:

Let  $P$  be a permutation on  $m$  letters. In this way we will write it as  $nw$  form since

$n$  is the permutation of  $S_n$  on  $n$  letters and  $w$  is a word of length at most 3. We write the elements of  $G$  as the following Permutation way.

$$\begin{aligned}
 NP &= 1^P = Nw \\
 \Rightarrow NP &= Nw, P \in NP \Rightarrow P \in Nw \\
 \Rightarrow P &= nw \text{ for some } n \in N \\
 \Rightarrow n &= Pw^{-1}
 \end{aligned}$$

**Example 7.8.** From the last group and the last example, we write the following Permutation in the Symmetric form,

Convert we take  $P = (1, 7)(2, 12)(3, 4, 5, 6)(8, 9, 10, 11)$ ;

$$NP = 1^P = 7 = Nt_0t_1$$

$$\Rightarrow n = Pt_1t_0 = (1, 7)(2, 12)(3, 4, 5, 6)(8, 9, 10, 11) \cdot$$

$$(1, 3)(2, 7)(4, 9)(5, 10)(6, 11)(8, 12) \cdot (1, 2)(3, 8)(4, 9)(5, 10)(6, 11)(7, 12)$$

$$\Rightarrow n = (2, 3, 4, 5, 6)(7, 8, 9, 10, 11)$$

We write  $n$  in it action on  $\{Nt_0, Nt_1, Nt_2, Nt_3, Nt_4\}$ , as the following;

$$\Rightarrow (Nt_0)^{(2,3,4,5,6)(7,8,9,10,11)} = 2^{(2,3,4,5,6)(7,8,9,10,11)} = 3 = Nt_1,$$

$$\Rightarrow (Nt_1)^{(2,3,4,5,6)(7,8,9,10,11)} = 3^{(2,3,4,5,6)(7,8,9,10,11)} = 4 = Nt_2,$$

$$\Rightarrow (Nt_2)^{(2,3,4,5,6)(7,8,9,10,11)} = 4^{(2,3,4,5,6)(7,8,9,10,11)} = 5 = Nt_3,$$

$$\Rightarrow (Nt_3)^{(2,3,4,5,6)(7,8,9,10,11)} = 5^{(2,3,4,5,6)(7,8,9,10,11)} = 6 = Nt_4,$$

$$\Rightarrow (Nt_4)^{(2,3,4,5,6)(7,8,9,10,11)} = 6^{(2,3,4,5,6)(7,8,9,10,11)} = 2 = Nt_0.$$

$$\Rightarrow n = (0, 1, 2, 3, 4)$$

$$\Rightarrow P = (0, 1, 2, 3, 4)t_0t_1$$

## Chapter 8

# Construction of $M_{22}$

### 8.1 Double Coset Enumeration of $M_{22} \times 2$ Over $S_6$

We take the progenitor  $2^{*30} : S_6$ , where  $2^{*30}$  is the free product of 30 copies of the cyclic groups of order 2, and  $S_6$  is the group of automorphisms of  $2^{*30}$  which permutes the thirty symmetric generators by conjugation and factor it by the two relations  $(x)t_4t_{23}t_{13}t_{15}t_{14} = 1$ , and  $(x)^4t_{16}t_9t_{16}t_9 = 1$ .

We write  $N = S_6 = \langle x, y \rangle$ .

The double coset enumeration partitions the image of the group  $G$  as a union double cosets  $NgN$  where  $g \in 2^{*30} : S_6$ . Thus, we can find the set of elements  $g_1, g_2, \dots$  of  $G$  such that  $G = Ng_1N \cup Ng_2N \cup \dots$ , and for each  $i$ , we have  $g_i = p_iw_i$ , where  $p_i \in N$ , and  $w_i$  is a word in the  $t_i$ s. Hence, the double coset decomposition is given by

$$G = Nw_1N \cup Nw_2N \cup Nw_3N \cup \dots,$$

where  $w_1 = e$  (the identity). We perform a double coset enumeration of the group  $\frac{2^{*30} : S_6}{[(x^{-3})ty^3]^5, [(x^{-3})ty^7]^4}$  over  $S_6$ . We will show

$$G = \frac{2^{*30} : (S_6)}{[(x^{-3})ty^3]^5, [(x^{-3})ty^7]^4} \cong M_{22} \times 2.$$

A symmetric presentation of the progenitor  $2^{*30} : (S_6)$  is given by:

$$2^{*30} : (S_6) \cong$$

$$\begin{aligned} & \text{G}\langle x, y, t \rangle := \text{Group}\langle x, y, t \mid x^8, y^8, (x*y^{-2}*x)^2, (x^{-1}*y^{-1})^4, (x*y^{-1})^4, \\ & (y^{-1}*x^{-1}*y*x^3*y*x^{-1}*y^{-1}*x), (y*x*y*x^3*y*x*y^2), t^2, (t, x^4), \\ & (t, x*y*x^{-1}*y^{-2}*x), (t, x*y*x*y*x^{-1}*y^{-1}) \rangle; \end{aligned}$$



$G$  is factored by  $((x^{-3}) * t^{(y^3)})^5 = 1 \Rightarrow ((x^{-3}) * t_{14})^5 = 1 \Rightarrow$   
 $(x^{-3})^5 t_{14}^{x^{-12}} t_{14}^{x^{-9}} t_{14}^{x^{-6}} t_{14}^{x^{-3}} t_{14}^0 = 1,$   
 and  $((x^{-3}) * t^{(y^7)})^4 = 1 \Rightarrow ((x^{-3}) * t_9)^4 = 1 \Rightarrow ((x^{-3})^4 t_9^{x^{-9}} t_9^{x^{-6}} t_9^{x^{-3}} t_9^0)^4 = 1$   
 which simplify to

$$(x)t_4 t_{23} t_{13} t_{15} t_{14} = 1, \text{ and } (x)^4 t_{16} t_9 t_{16} t_9 = 1.$$

$N \cong S_6 = \langle x, y \rangle$ , where

$$x \sim (1, 2, 4, 8)(3, 6, 11, 18, 26, 20, 29, 22)(5, 10, 17, 12, 19, 28, 30, 25)$$

$$(7, 13, 21, 27, 15, 24, 23, 14)(9, 16) ,$$

$$\text{and } y \sim (1, 3, 7, 14, 23, 29, 4, 9)(2, 5, 10, 6, 12, 20, 28, 30)(8, 15, 25, 21)$$

$$(11, 16, 26, 19, 13, 22, 24, 17)(18, 27).$$

Let  $t = t_1$ . The order of  $N$  is 720.

**Using computer-based program - MAGMA extensively through this DCE:**

1. The order of the group,  $|G|$  is equal to 887040 .
2. There are 10 double cosets in this double coset enumeration of  $M_{22} \times 2$  over  $S_6$ .

### Relations

We see that

$$(I) [(x^{-3})t^{y^3}]^5 = 1 \Rightarrow (x)t_{27}t_{23}t_{13}t_{15}t_{14} = 1.$$

Moreover, if we conjugate the previous relation by all elements in  $S_6$ , different relations we obtain

- $((x)t_{27}t_{23}t_{13}t_{15}t_{14} = 1)^e \Rightarrow xt_{27}t_{23}t_{13}t_{15}t_{14} = 1.$
- $((x)t_{27}t_{23}t_{13}t_{15}t_{14} = 1)^x \Rightarrow xt_{15}t_{14}t_{21}t_{24}t_7 = 1.$
- $((x)t_{27}t_{23}t_{13}t_{15}t_{14} = 1)^y \Rightarrow (x^y)t_{18}t_{29}t_{22}t_{25}t_{23} = 1.$
- $((x)t_{27}t_{23}t_{13}t_{15}t_{14} = 1)^z \Rightarrow (x^z)t_{16}t_9t_{16}t_9 = 1.$

We obtain

- $((x)^4 t_{16} t_9 t_{16} t_9 = 1)^e \Rightarrow (x)^4 t_{16} t_9 t_{16} t_9 = 1.$
- $((x)^4 t_{16} t_9 t_{16} t_9 = 1)^x \Rightarrow (x)^4 t_9 t_{16} t_9 t_{16} = 1.$
- $((x)^4 t_{16} t_9 t_{16} t_9 = 1)^y \Rightarrow (x^y)^4 t_{16} t_9 t_{16} t_9 = 1.$
- $((x)^4 t_{16} t_9 t_{16} t_9 = 1)^z \Rightarrow (x^z)^4 t_{16} t_9 t_{16} t_9 = 1.$

- $((x)^4 t_{16} t_9 t_{16} t_9 = 1)^y \Rightarrow ((y^{-1} x y)^4) t_{26} t_1 t_{26} t_1 = 1.$

### Double Coset [\*]:

We start with the double coset  $NeN$ , where  $e$  is the word of length zero, denoted by [\*]. We have

$$NeN = \{Nen : n \in N\} = \{Ne\} = \{N\}$$

So, the double coset  $NeN$  consists of the single coset  $N$ . Thus,  $\frac{|N|}{|N|} = \frac{720}{720} = 1$ . Note, since  $N$  is transitive on  $\{1, 2, \dots, 30\}$ , we take a representative coset  $N$  from [\*] and a representative from  $\{1, 2, \dots, 30\}$  and determine the double coset to which  $Nt_i$  belongs, where  $i \in \{1, 2, \dots, 30\}$ . We consider  $i = 1$ , so  $Nt_1$  is the representative coset, and hence we will have a new double coset  $Nt_1N$  which can denoted by [1]. There will be 30 possi- bles  $t_i$ s in [\*] that will advance to the next double cosets [1].

### Word of Length One [1]:

We consider the double coset  $NwN$ , where  $w$  is a word of length one.

$Nt_1N = \{Nt_1^n | n \in N\} = [1]$ . We need to find the point stabilizer of 1. So,  $Nt_1N = [1] = \{Nt_1^n | n \in N\} = \{Nt_1N, Nt_2N, \dots, Nt_{30}N\}$ . Since, the point stabilizer of 1 in the subgroup  $N$  is the permutations in  $N$  that fixes 1 and permutes the rest of the elements in the set  $\{1, 2, \dots, 30\}$ . The coset stabilizer of the coset  $Nt_1$  is  $N^{(1)} = \{n \in N | t_1^n = t_1\}$

$$= < (3, 26)(5, 19)(6, 20)(7, 15)(10, 28)(11, 29)(12, 25)(13, 24) \\ (14, 27)(17, 30)(18, 22)(21, 23), \\ (2, 12)(4, 15)(5, 16)(6, 22)(8, 28)(9, 26)(11, 24)(13, 14) \\ (17, 18)(20, 30)(21, 23)(27, 29), \\ (2, 27)(4, 5)(6, 21)(8, 24)(9, 26)(10, 25)(11, 28)(12, 29) \\ (15, 16)(17, 30)(18, 20)(22, 23) >$$

Since  $|N^{(1)}| = 24$ , the number of single cosets in [1] is  $\frac{|N|}{|N^{(1)}|} = \frac{720}{24} = 30$ .

Now, the orbits of  $N^{(1)}$  on  $\{1, 2, \dots, 30\}$  are  $\{1\}$ ,  $\{2, 12, 27, 25, 29, 14, 10, 11, 13, 28, 24, 8\}$ ,  $\{3, 26, 9\}$ ,  $\{4, 15, 5, 7, 16, 9\}$  and  $\{6, 20, 22, 21, 30, 18, 23, 17\}$ . We choose a representative from each orbit, determine the double costs that contain  $Nt_1t_i$ ,  $i = 1, 2, 3, 4$  and 6.

- $Nt_1 \cdot t_1 = Nt_1^2 = N \in [*]$ . This will go back to  $[*]$ . Since there is one element in this orbit, there is one  $t_i$  that takes  $[1]$  to  $[*]$ .
- $Nt_1 \cdot t_2 = Nt_1t_2 \in [12]$ . This is a new double coset, which will extend the Cayley graph from  $[1]$  to  $[12]$ . Since there are 12 elements in this orbit, there are 12  $t'_i$ s that take  $[1]$  to  $[12]$ .
- $Nt_1 \cdot t_3 = Nt_1t_3 \in [13]$ . This is a new double coset, which extends our graph from  $[1]$  to  $[13]$ . Since there are 3 elements in this orbit, there are 3  $t'_i$ s that take  $[1]$  to  $[13]$ .
- $Nt_1 \cdot t_4 = Nt_1t_4 \in [14]$ . This is a new double coset, which extends our graph from  $[1]$  to  $[14]$ . Since there are 6 elements in this orbit, there are 6  $t'_i$ s that take  $[1]$  to  $[14]$ .
- $Nt_1 \cdot t_6 = Nt_1t_6$ . This give the relation  $t_1t_6 = t_{18}t_{16}$ . This double coset will go to  $[1, 4]$ . Since there are 8 elements in this orbit, there are 8  $t'_i$ s that take  $[1]$  to  $[1, 4]$ .

### Word of Length Two $[1, 2]$ , $[13]$ , and $[14]$

(i) We are at a new double coset  $[12]$ ,  $Nt_1t_2N = \{N(t_1t_2)^n | n \in N\}$ . Now, to determine all the single cosets of this double cosets, we need to determine the point stabilizer of  $N^{12}$ , this means finding the set of elements that fix 1 and 2 in  $N$  and permute the rest elements of the elements in the set  $\{1, 2, \dots, 30\}$ . The coset stabilizer of the coset  $Nt_1t_2$  is  $N^{(12)} = \{n \in N | (t_1t_2)^n = t_1t_2\}$

$$= \langle (3, 26)(5, 19)(6, 20)(7, 15)(10, 28)(11, 29)(12, 25) \\ (13, 24)(14, 27)(17, 30)(18, 22)(21, 23) \rangle.$$

Since  $|N^{(12)}| = 2$ , the number of single cosets in  $[12]$  is  $\frac{|N|}{|N^{(12)}|} = \frac{720}{2} = 360$ .

Now, the orbits of  $N^{(12)}$  on  $\{1, 2, \dots, 30\}$  are  $\{1\}$ ,  $\{2\}$ ,  $\{3, 26\}$ ,  $\{4\}$ ,  $\{5, 19\}$ ,  $\{6, 20\}$ ,  $\{7, 15\}$ ,  $\{8\}$ ,  $\{9\}$ ,  $\{10, 28\}$ ,  $\{11, 29\}$ ,  $\{12, 25\}$ ,  $\{13, 24\}$ ,  $\{14, 27\}$ ,  $\{16\}$ ,  $\{17, 30\}$ ,  $\{18, 22\}$ , and  $\{21, 23\}$ . We choose a representative from each orbit, find the double costs to which  $Nt_1t_2t_i$  belongs to each

$i \in \{1, 2, 3, 4, 5, 6, 7, 8, 9, 10, 11, 12, 13, 14, 16, 17, 18, 21\}$ .

- $Nt_1t_2 \cdot t_1 = Nt_1t_2t_1$ . This gives the relation  $t_1t_2t_1 = (yx^{-2}y)t_1t_2t_4$ . This double coset will go to  $[1, 2, 4]$ . Since there is one element in this orbit, there is one  $t_i$  that takes  $[1, 2]$  to  $[1, 2, 4]$ .

- $Nt_1t_2 \cdot t_2 = Nt_1t_2^2 \in [1]$ . This will go back to  $[1]$ . Since there is one element in this orbit, there is one  $t_i$  that takes  $[12]$  to  $[1]$ .
- $Nt_1t_2 \cdot t_3 = Nt_1t_2t_3 \in [123]$ . This is a new double coset, which extends our graph from  $[12]$  to  $[123]$ . Since there are 2 elements in this orbit, there are 2  $t'_i$ s that take  $[12]$  to  $[123]$ .
- $Nt_1t_2 \cdot t_4 = Nt_1t_2t_4 \in [124]$ . This is a new double coset, which extends our graph from  $[12]$  to  $[124]$ . Since there is one element in this orbit, there is one  $t_i$  that takes  $[12]$  to  $[124]$ .
- $Nt_1t_2 \cdot t_5 = Nt_1t_2t_5$ . This gives the relation  $t_1t_2t_5 = (xy^{-1}x^{-2}y^{-1})t_{20}t_9$ . This double coset will collapse. Since there are 2 elements in this orbit, there are 2  $t'_i$ s that take  $[1, 2]$  to  $[1, 2]$ .
- $Nt_1t_2 \cdot t_6 = Nt_1t_2t_6$ . This gives the relation  $t_1t_2t_6 = (y^{-1}x^{-1}y^2)^2t_4t_{26}t_{29}$ . This double coset will go to  $[1, 2, 3]$ . Since there are 2 elements in this orbit, there are 2  $t'_i$ s that take  $[1, 2]$  to  $[1, 2, 3]$ .
- $Nt_1t_2 \cdot t_7 = Nt_1t_2t_7$ . This gives the relation  $t_1t_2t_7 = (yxyx^{-1}y^{-2}x)t_6t_9$ . This double coset will collapse. Since there are 2 elements in this orbit, there are 2  $t'_i$ s that take  $[1, 2]$  to  $[1, 2]$ .
- $Nt_1t_2 \cdot t_8 = Nt_1t_2t_8 \in [128]$ . This is a new double coset, which extends our graph from  $[12]$  to  $[128]$ . Since there is one element in this orbit, there is one  $t_i$  that takes  $[12]$  to  $[128]$ .
- $Nt_1t_2 \cdot t_9 = Nt_1t_2t_9$ . This gives the relation  $t_1t_2t_9 = t_1t_{29}t_3$ . This double coset will go to  $[1, 2, 3]$ . Since there is one element in this orbit, there is one  $t_i$  that takes  $[1, 2]$  to  $[1, 2, 3]$ .
- $Nt_1t_2 \cdot t_{10} = Nt_1t_2t_{10}$ . This gives the relation  $t_1t_2t_{10} = t_1t_{28}t_9$ . This double coset will go to  $[1, 2, 3]$ . Since there are 2 elements in this orbit, there are 2  $t'_i$ s that take  $[1, 2]$  to  $[1, 2, 3]$ .
- $Nt_1t_2 \cdot t_{11} = Nt_1t_2t_{11}$ . This gives the relation  $t_1t_2t_{11} = t_1t_{13}t_{14}$ . This double coset will go to  $[1, 2, 8]$ . Since there are 2 elements in this orbit, there are 2  $t'_i$ s that take  $[1, 2]$  to  $[1, 2, 8]$ .

- $Nt_1t_2 \cdot t_{12} = Nt_1t_2t_{12}$ . This gives the relation  $t_1t_2t_{12} = t_1t_{14}t_9$ . This double coset will send to  $[1, 2, 3]$ . Since there are 2 elements in this orbit, there are 2  $t'_i$ s that take  $[1, 2]$  to  $[1, 2, 3]$ .
- $Nt_1t_2 \cdot t_{13} = Nt_1t_2t_{13}$ . This gives the relation  $Nt_1t_2t_{13} = t_1t_{27}t_3$ . This double coset will go to  $[1, 2, 3]$ . Since there are 2 elements in this orbit, there are 2  $t'_i$ s that take  $[1, 2]$  to  $[1, 2, 3]$ .
- $Nt_1t_2 \cdot t_{14} = Nt_1t_2t_{14}$ . This gives the relation  $t_1t_2t_{14} = t_1t_{12}t_9$ . This double coset will go to  $[1, 2, 3]$ . Since there are 2 elements in this orbit, there are 2  $t'_i$ s that take  $[1, 2]$  to  $[1, 2, 3]$ .
- $Nt_1t_2 \cdot t_{16} = Nt_1t_2t_{16}$ . This gives the relation  $t_1t_2t_{16} = (yx^{-2}y)t_1t_{29}t_{26}$ . This double coset will go to  $[1, 2, 3]$ . Since there is one element in this orbit, there is one  $t_i$  that takes  $[1, 2]$  to  $[1, 2, 3]$ .
- $Nt_1t_2 \cdot t_{17} = Nt_1t_2t_{17} \in [1, 2, 17]$ . This is a new double coset, which extends our graph from  $[12]$  to  $[1, 2, 17]$ . Since there are two elements in this orbit, there are 2  $t_i$  that take  $[12]$  to  $[1, 2, 17]$ .
- $Nt_1t_2 \cdot t_{18} = Nt_1t_2t_{18}$ . This gives the relation  $t_1t_2t_{18} = (yxy^{-2})^2t_4t_2t_1$ . This double coset will go to  $[1, 2, 4]$ . Since there are two elements in this orbit, there are 2  $t'_i$ s that take  $[1, 2]$  to  $[1, 2, 4]$ .
- $Nt_1t_2 \cdot t_{21} = Nt_1t_2t_{21}$ . This gives the relation  $t_1t_2t_{21} = (yx^{-2}y)t_1t_2t_{17}$ . This double coset will go to  $[1, 2, 17]$ . Since there are 2 elements in this orbit, there are 2  $t'_i$ s that take  $[1, 2]$  to  $[1, 2, 17]$ .

(ii) We are at a new double coset  $[1, 3]$ ,  $Nt_1t_3N = \{N(t_1t_3)^n | n \in N\}$ . Now, to determine all the single cosets of this double cosets, we need to determine the point stabilizer  $N^{13}$ , this means finding the set of elements that fix 1 and 3 in  $N$  and permute the rest elements of the set  $\{1, 2, \dots, 30\}$ .

The coset stabilizer of the coset  $Nt_1t_3$  is  $N^{(13)} = \{n \in N | (t_1t_3)^n = t_1t_3\}$

$$\begin{aligned}
&= \langle (2, 12)(4, 15)(5, 16)(6, 22)(8, 28)(9, 26)(11, 24)(13, 14) \\
&\quad (17, 18)(20, 30)(21, 23)(27, 29), \\
&\quad (2, 27)(4, 5)(6, 21)(8, 24)(9, 26)(10, 25)(11, 28)(12, 29) \\
&\quad (15, 16)(17, 30)(18, 20)(22, 23), \rangle
\end{aligned}$$

(2, 11)(4, 16)(6, 30)(7, 19)(8, 29)(10, 13)(12, 28)(14, 25)  
 (17, 22)(18, 23)(20, 21)(24, 27),  
 (1, 3)(2, 20, 24, 23, 29, 17, 28, 6)(4, 25, 5, 13, 16, 10,  
 15, 14)(7, 9, 19, 26)(8, 30, 27, 22, 11, 18, 12, 21)>.

Since  $|N^{(13)}| = 16$ , the number of single cosets in [13] is  $\frac{|N|}{|N^{(13)}|} = \frac{720}{16} = 45$ .

Now, the orbits of  $N^{(13)}$  on  $\{1, 2, \dots, 30\}$  are  $\{1, 3\}$ ,  $\{2, 12, 27, 11, 20, 21, 22, 17, 18, 6, 23, 30, 29, 28, 24, 8\}$ ,  $\{4, 15, 5, 16, 25, 14, 13, 10\}$ , and  $\{7, 19, 9, 26\}$ . We choose a representative from each orbit, find the double cosets to which  $Nt_1t_3t_i$  belongs to each  $i \in \{2, 3, 4, 7\}$ .

- $Nt_1t_3 \cdot t_3 = Nt_1t_3^2 \in [1]$ . This will go back to [1]. Since there are two elements in this orbit, there are 2  $t'_i$ s that take [1, 3] to [1].
- $Nt_1t_3 \cdot t_2 = Nt_1t_3t_2$ . This gives the relation  $Nt_1t_3t_2 = t_1t_2t_3$ . This double coset will go to [1, 2, 3]. Since there are 16 elements in this orbit, then there will be 16  $t'_i$ s that take [1, 3] to [1, 2, 3].
- $Nt_1t_3 \cdot t_4 = Nt_1t_3t_4$ . This gives the relation  $t_1t_3t_4 = (y^2x^2yx)t_3t_5t_7$ . This double coset will go to [1, 2, 3]. Since there are 8 elements in this orbit, there are 8  $t'_i$ s that take [1, 3] to [1, 2, 3].
- $Nt_1t_3 \cdot t_7 = Nt_1t_3t_7$ . This gives the relation  $t_1t_3t_7 = (xyxyx^{-1}y^{-1})t_{19}t_{26}t_9$ . This double coset will go to [1, 2, 8]. Since there are 4 elements in this orbit, there are 4  $t'_i$ s that take [1, 3] to [1, 2, 8].

(iii) We are at a new double coset [1, 4],  $Nt_1t_4N = \{N(t_1t_4)^n | n \in N\}$ . Now, to determine all the single cosets of this double cosets, we need to determine the point stabilizer  $N^{14}$ , this means finding the set of elements that fix 1 and 4 in  $N$  and permute the rest of the elements in the set  $\{1, 2, \dots, 30\}$ .

The coset stabilizer of the coset  $Nt_1t_4$  is  $N^{(14)} = \{n \in N | (t_1t_4)^n = t_1t_4\}$

= < (2, 8)(3, 26)(5, 7)(6, 22)(10, 27)(12, 13)(14, 28)(15, 19)  
 (17, 23)(18, 20)(21, 30)(24, 25),  
 (2, 8)(5, 15)(6, 18)(7, 19)(10, 14)(11, 29)(12, 24)(13, 25)  
 (17, 21)(20, 22)(23, 30)(27, 28),  
 (1, 4)(2, 8)(3, 11, 26, 29)(5, 17, 19, 30)(6, 18, 20, 22)  
 (7, 21, 15, 23)(10, 12, 28, 25)(13, 27, 24, 14),  
 (1, 4)(2, 8)(3, 29, 26, 11)(5, 30, 19, 17)(6, 22, 20, 18)

(7, 23, 15, 21)(10, 25, 28, 12)(13, 14, 24, 27),  
 (1, 4)(3, 11)(5, 23)(6, 20)(7, 30)(10, 13)(12, 14)(15, 17)  
 (19, 21)(24, 28)(25, 27)(26, 29),  
 (1, 4)(3, 29)(5, 21)(7, 17)(10, 24)(11, 26)(12, 27)(13, 28)  
 (14, 25)(15, 30)(18, 22)(19, 23),  
 (1, 18)(3, 27)(4, 22)(5, 17)(7, 21)(8, 9)(10, 24)(11, 14)  
 (12, 29)(15, 19)(23, 30)(25, 26)>.

Since  $|N^{(14)}| = 24$ , the number of single cosets in  $[14]$  is  $\frac{|N|}{|N^{(14)}|} = \frac{720}{24} = 30$ .

Now, the orbits of  $N^{(14)}$  on  $\{1, 2, \dots, 30\}$  are  $\{1, 4, 18, 20, 6, 22\}$ ,  $\{2, 8, 9\}$ ,  $\{3, 26, 11, 29, 27, 25, 10, 24, 13, 28, 14, 12\}$ ,  $\{5, 7, 15, 17, 30, 23, 21, 19\}$ , and  $\{16\}$ . We choose a representative from each orbit, find the double costs to which  $Nt_1t_4t_i$  belongs to each  $i \in \{2, 3, 4, 5, 16\}$ .

- $Nt_1t_4 \cdot t_4 = Nt_1t_4^2 \in [1]$ . This will go back to  $[1]$ . Since there are 6 elements in this orbit, there are 6  $t'_i$ s that take  $[14]$  to  $[1]$ .
- $Nt_1t_4 \cdot t_2 = Nt_1t_4t_2$ . This gives the relation  $t_1t_4t_2 = t_{16}t_{28}t_{13}$ . This double coset will go to  $[1, 2, 8]$ . Since there are 3 elements in this orbit, there are 3  $t'_i$ s that take  $[1, 4]$  to  $[1, 2, 8]$ .
- $Nt_1t_4 \cdot t_3 = Nt_1t_4t_3$ . This gives the relation  $t_1t_4t_3 = t_{16}t_{29}t_8$ . This double coset will go to  $[1, 2, 3]$ . Since there are 12 elements in this orbit, there are 12  $t'_i$ s that take  $[1, 4]$  to  $[1, 2, 3]$ .
- $Nt_1t_4 \cdot t_5 = Nt_1t_4t_5$ . This gives the relation  $t_1t_4t_5 = t_7$ . This double coset will go back to  $[1]$ . Since there are 8 elements in this orbit, there are 8  $t'_i$ s that take  $[1, 4]$  to  $[1]$ .
- $Nt_1t_4 \cdot t_{16} = Nt_1t_4t_{16} \in [1, 4, 16]$ . This is a new double coset, which extends our graph from  $[14]$  to  $[1, 4, 16]$ . Since there is one element in this orbit, there is one  $t_i$  that takes  $[14]$  to  $[1, 4, 16]$ .

**Word of Length Three**  $[123]$ ,  $[124]$ ,  $[128]$ ,  $[1, 2, 17]$  **and**  $[1, 4, 16]$ :

(i) We are at a new double coset  $[1, 2, 3]$ ,  $Nt_1t_2t_3N = \{N(t_1t_2t_3)^n | n \in N\}$ . Now, to determine all the single cosets of this double cosets, we need to determine the point stabilizer  $N^{123}$ , this means finding the set of elements that fix 1, 2, and 3 in  $N$  and

permute the rest of the elements in the set  $\{1, 2, \dots, 30\}$ . The coset stabilizer of the coset  $Nt_1t_2t_3$  is  $N^{(123)} = \{n \in N \mid (t_1t_2t_3)^n = t_1t_2t_3\}$

$$= \langle (2, 8)(3, 26)(5, 7)(6, 22)(10, 27)(12, 13)(14, 28)(15, 19) \\ (17, 23)(18, 20)(21, 30)(24, 25) \rangle.$$

Since  $|N^{(123)}| = 2$ , the number of single cosets in  $[123]$  is  $\frac{|N|}{|N^{(123)}|} = \frac{720}{2} = 360$ .

Now, the orbits of  $N^{123}$  on  $\{1, 2, \dots, 30\}$  are  $\{1\}$ ,  $\{2, 8\}$ ,  $\{3, 26\}$ ,  $\{4\}$ ,  $\{5, 7\}$ ,  $\{6, 22\}$ ,  $\{9\}$ ,  $\{10, 27\}$ ,  $\{11\}$ ,  $\{12, 13\}$ ,  $\{14, 28\}$ ,  $\{15, 19\}$ ,  $\{16\}$ ,  $\{17, 23\}$ ,  $\{18, 20\}$ ,  $\{21, 30\}$ ,  $\{24, 25\}$ , and  $\{29\}$ . We choose a representative from each orbit, find the double cosets to which  $Nt_1t_2t_3t_i$  belongs to each

$i \in \{1, 2, 3, 4, 5, 6, 9, 10, 11, 12, 14, 15, 16, 17, 18, 21, 24, 29\}$ .

- $Nt_1t_2t_3 \cdot t_1 = Nt_1t_2t_1$ . This gives the relation  $Nt_1t_2t_3t_1 = (xy^2xy^2x)t_3t_4t_{27}$ . This double coset will go to  $[1, 2, 17]$ . Since there is one element in this orbit, there is one  $t_i$  that takes  $[1, 2, 3]$  to  $[1, 2, 17]$ .
- $Nt_1t_2t_3 \cdot t_2 = Nt_1t_2t_3t_2 = Nt_1t_3t_2t_2 = Nt_1t_3t_2^2 \in [1, 3]$ . This double coset will go back to  $[1, 3]$ . Since there are 2 elements in this orbit, there are 2  $t'_i$ 's that take  $[1, 2, 3]$  to  $[1, 3]$ .
- $Nt_1t_2t_3 \cdot t_3 = Nt_1t_2 \in [12]$ . This double coset will go back to  $[1, 2]$ . Since there are 2 elements in this orbit, there are 2  $t'_i$ 's that take  $[1, 2, 3]$  to  $[1, 2]$ .
- $Nt_1t_2t_3 \cdot t_4 = Nt_1t_2t_3t_4$ . This gives the relation  $t_1t_2t_3t_4 = (yxy^{-1})t_1t_{11}$ . This double coset will go back to  $[1, 2]$ . Since there is one element in this orbit, there is one  $t_i$  that takes  $[1, 2, 3]$  to  $[1, 2]$ .
- $Nt_1t_2t_3 \cdot t_5 = Nt_1t_2t_3t_5$ . This gives the relation  $Nt_1t_2t_3t_5 = (x^{-2}y^{-1}x^{-2})t_{30}t_{13}t_{10}$ . This double coset will collapse. Since there are 2 elements in this orbit, there are 2  $t'_i$ 's that take  $[1, 2, 3]$  to  $[1, 2, 3]$ .
- $Nt_1t_2t_3 \cdot t_6 = Nt_1t_2t_3t_6$ . This gives the relation  $t_1t_2t_3t_6 = (y^4xyx^{-1})t_9t_{21}t_{29}$ . This double coset will go to  $[1, 2, 4]$ . Since there are 2 elements in this orbit, there are 2  $t'_i$ 's that take  $[1, 2, 3]$  to  $[1, 2, 4]$ .
- $Nt_1t_2t_3 \cdot t_9 = Nt_1t_2t_3t_9$ . This gives the relation  $t_1t_2t_3t_9 = t_1t_{29}$ . This double coset will go back to  $[1, 2]$ . Since there is one element in this orbit, there is one  $t_i$  that takes  $[1, 2, 3]$  to  $[1, 2]$ .



- $Nt_1t_2t_3 \cdot t_{10} = Nt_1t_2t_3t_{10}$ . This gives the relation  $t_1t_2t_3t_{10} = t_1t_{12}$ . This double coset will go back to  $[1, 2]$ . Since there are 2 elements in this orbit, there are 2  $t'_i$ s that take  $[1, 2, 3]$  to  $[1, 2]$ .
- $Nt_1t_2t_3 \cdot t_{11} = Nt_1t_2t_3t_{11}$ . This gives the relation  $t_1t_2t_3t_{11} = t_4t_{16}$ . This double coset will go back to  $[1, 4]$ . Since there is one element in this orbit, there is one  $t_i$  that takes  $[1, 2, 3]$  to  $[1, 4]$ .
- $Nt_1t_2t_3 \cdot t_{12} = Nt_1t_2t_3t_{12}$ . This gives the relation  $t_1t_2t_3t_{12} = t_1t_{10}$ . This double coset will go back to  $[1, 2]$ . Since there are 2 elements in this orbit, there are 2  $t'_i$ s that take  $[1, 2, 3]$  to  $[1, 2]$ .
- $Nt_1t_2t_3 \cdot t_{14} = Nt_1t_2t_3t_{14}$ . This gives the relation  $t_1t_2t_3t_{14} = t_1t_{28}$ . This double coset will go back to  $[1, 2]$ . Since there are 2 elements in this orbit, there are 2  $t'_i$ s that take  $[1, 2, 3]$  to  $[1, 2]$ .
- $Nt_1t_2t_3 \cdot t_{15} = Nt_1t_2t_3t_{15}$ . This gives the relation  $t_1t_2t_3t_{15} = (xyx^{-1}y^{-1}x^{-1}yx)t_{21}t_{10}t_{13}$ . This double coset will collapse. Since there are 2 elements in this orbit, there are 2  $t'_i$ s that take  $[1, 2, 3]$  to  $[1, 2, 3]$ .
- $Nt_1t_2t_3 \cdot t_{16} = Nt_1t_2t_3t_{16}$ . This gives the relation  $t_1t_2t_3t_{16} = (x^{-1}yx^2y)t_{26}t_4t_{10}$ . This double coset will go to  $[1, 2, 17]$ . Since there is one element in this orbit, there is one  $t_i$  that takes  $[1, 2, 3]$  to  $[1, 2, 17]$ .
- $Nt_1t_2t_3 \cdot t_{17} = Nt_1t_2t_3t_{17}$ . This gives the relation  $t_1t_2t_3t_{17} = (x^{-2}y^{-1}x^2)t_{21}t_9t_{20}$ . This double coset will go to  $[1, 2, 17]$ . Since there are two elements in this orbit, there are 2  $t'_i$ s that take  $[1, 2, 3]$  to  $[1, 2, 17]$ .
- $Nt_1t_2t_3 \cdot t_{18} = Nt_1t_2t_3t_{18}$ . This gives the relation  $t_1t_2t_3t_{18} = (x^{-2}y^{-1}x^2)t_{21}t_9t_{30}$ . This double coset will go to  $[1, 2, 4]$ . Since there are two elements in this orbit, there are 2  $t'_i$ s that take  $[1, 2, 3]$  to  $[1, 2, 4]$ .
- $Nt_1t_2t_3 \cdot t_{21} = Nt_1t_2t_3t_{21}$ . This gives the relation  $t_1t_2t_3t_{21} = (xyx^{-1})^4t_{16}t_{11}$ . This double coset will go back to  $[1, 2]$ . Since there are two elements in this orbit, there are 2  $t'_i$ s that take  $[1, 2, 3]$  to  $[1, 2]$ .

- $Nt_1t_2t_3 \cdot t_{24} = Nt_1t_2t_3t_{24}$ . This gives the relation  $t_1t_2t_3t_{24} = t_1t_{25}$ . This double coset will go back to  $[1, 2]$ . Since there are two elements in this orbit, there are 2  $t'_i$ s that take  $[1, 2, 3]$  to  $[1, 2]$ .
- $Nt_1t_2t_3 \cdot t_{29} = Nt_1t_2t_3t_{29}$ . This gives the relation  $t_1t_2t_3t_{29} = t_1t_9$ . This double coset will go back to  $[1, 3]$ . Since there is one element in this orbit, there is one  $t_i$  that takes  $[1, 2, 3]$  to  $[1, 3]$ .

(ii) We are at a new double coset  $[1, 2, 4]$ ,  $Nt_1t_2t_4N = \{N(t_1t_2t_4)^n | n \in N\}$ . Now, to determine all the single cosets of this double cosets, we need to determine the point stabilizer  $N^{124}$ , this means finding the set of elements that fix 1, 2, and 4 in  $N$  and permute the rest of the elements in the set  $\{1, 2, \dots, 30\}$ . The coset stabilizer of the coset  $Nt_1t_2t_4$  is  $N^{(124)} = \{n \in N | (t_1t_2t_4)^n = t_1t_2t_4\}$

$$= \langle (1, 2)(3, 6, 26, 20)(4, 8)(5, 24, 19, 13)(7, 28, 15, 10) \\ (9, 16)(11, 22, 29, 18)(12, 23, 25, 21)(14, 17, 27, 30) \rangle.$$

Since  $|N^{(124)}| = 4$  then the number of single cosets in  $[124]$  is  $\frac{|N|}{|N^{(124)}|} = \frac{720}{4} = 180$ .

Now, the orbits of  $N^{124}$  on  $\{1, 2, \dots, 30\}$  are  $\{1, 2\}$ ,  $\{4, 8\}$ ,  $\{9, 16\}$ ,  $\{3, 26, 6, 20\}$ ,  $\{5, 15, 24, 13\}$ ,  $\{7, 15, 28, 10\}$ ,  $\{11, 29, 22, 18\}$ ,  $\{12, 25, 23, 21\}$ ,

and  $\{14, 27, 17, 30\}$ . We choose a representative from each orbit, find the double costs to which  $Nt_1t_2t_4t_i$  belongs to each  $i \in \{1, 3, 4, 5, 7, 9, 11, 12, 14\}$ .

- $Nt_1t_2t_4 \cdot t_1 = Nt_1t_2t_4t_1$ . This gives the relation  $t_1t_2t_4t_1 = (yx^{-2}y)t_1t_2$ . This double coset will go back to  $[1, 2]$ . Since there are two elements in this orbit, there are 2  $t'_i$ s that take  $[1, 2, 4]$  to  $[1, 2]$ .
- $Nt_1t_2t_4 \cdot t_3 = Nt_1t_2t_4t_3$ . This gives the relation  $t_1t_2t_4t_3 = (y^{-1}x^{-2})t_{22}t_9t_{15}$ . This double coset will go to  $[1, 2, 17]$ . Since there are 4 elements in this orbit, there are 4  $t'_i$ s that take  $[1, 2, 4]$  to  $[1, 2, 17]$ .
- $Nt_1t_2t_4 \cdot t_4 = Nt_1t_2t_4^2 = Nt_1t_2 \in [1, 2]$ . This double coset will go back to  $[1, 2]$ . Since there are 2 elements in this orbit, there are 2  $t'_i$ s that take  $[1, 2, 4]$  to  $[1, 2]$ .
- $Nt_1t_2t_4 \cdot t_5 = Nt_1t_2t_4t_5$ . This gives the relation  $t_1t_2t_4t_5 = (xyx^{-2}xyx^{-1})t_{20}t_{13}t_{10}$ . This double coset will go to  $[1, 2, 3]$ . Since there are 4 elements in this orbit, there are 4  $t'_i$ s that take  $[1, 2, 4]$  to  $[1, 2, 3]$ .

- $t_1 t_2 t_4 \cdot t_7 = N t_1 t_2 t_4 t_7$ . This gives the relation  $t_1 t_2 t_4 t_7 = (y x y x^{-1} y^{-1}) t_{20} t_{13} t_{10}$ . This double coset will go to  $[1, 2, 3]$ . Since there are 4 elements in this orbit, there are 4  $t'_i$ s that take  $[1, 2, 4]$  to  $[1, 2, 3]$ .
- $N t_1 t_2 t_4 \cdot t_9 = N t_1 t_2 t_4 t_9$ . This gives the relation  $t_1 t_2 t_4 t_9 = (x^{-1} y^{-1} x^{-2} y^{-1}) t_{20} t_9 t_5$ . This double coset will go to  $[1, 2, 17]$ . Since there are 2 elements in this orbit, there are 2  $t'_i$ s that take  $[1, 2, 4]$  to  $[1, 2, 17]$ .
- $N t_1 t_2 t_4 \cdot t_{11} = N t_1 t_2 t_4 t_{11}$ . This gives the relation  $t_1 t_2 t_4 t_{11} = (x^2 y^{-1} x^{-2} y^{-1} x^{-2}) t_8 t_1$ . This double coset will go back to  $[1, 2]$ . Since there are 4 elements in this orbit, there are 4  $t'_i$ s that take  $[1, 2, 4]$  to  $[1, 2]$ .
- $N t_1 t_2 t_4 \cdot t_{12} = N t_1 t_2 t_4 t_{12}$ . This gives the relation  $t_1 t_2 t_4 t_{12} = (x^{-2} y^{-1}) t_{16} t_3 t_4$ . This double coset will collapse. Since there are 4 elements in this orbit, there are 4  $t'_i$ s that take  $[1, 2, 4]$  to  $[1, 2, 4]$ .
- $N t_1 t_2 t_4 \cdot t_{14} = N t_1 t_2 t_4 t_{14}$ . This gives the relation  $t_1 t_2 t_4 t_{14} = (y x^2) t_{16} t_{26} t_4$ . This double coset will collapse. Since there are 4 elements in this orbit, there are 4  $t'_i$ s that take  $[1, 2, 4]$  to  $[1, 2, 4]$ .

(iii) We are at a new double coset  $[1, 2, 8]$ ,  $N t_1 t_2 t_8 N = \{N(t_1 t_2 t_8)^n | n \in N\}$ .

Now, to determine all the single cosets of this double cosets, we need to determine the point stabilizer  $N^{128}$ , this means finding the set of elements that fix 1, 2, and 8 in  $N$  and permute the rest of the elements in the set  $\{1, 2, \dots, 30\}$ . The coset stabilizer of the coset  $N t_1 t_2 t_8$  is  $N^{(128)} = \{n \in N | (t_1 t_2 t_8)^n = t_1 t_2 t_8\}$

$$\begin{aligned}
&= \langle (3, 26)(5, 19)(6, 20)(7, 15)(10, 28)(11, 29)(12, 25)(13, 24) \\
&\quad (14, 27)(17, 30)(18, 22)(21, 23) \\
&\quad (1, 9)(2, 15, 29, 7, 8, 5, 11, 19)(3, 16, 26, 4)(6, 27, 17, 13, \\
&\quad 18, 28, 21, 25)(10, 20, 24, 23, 14, 22, 12, 30) \rangle.
\end{aligned}$$

Since  $|N^{(128)}| = 16$ , the number of single cosets in  $[128]$  is  $\frac{|N|}{|N^{(128)}|} = \frac{720}{16} = 45$ .

Now, the orbits of  $N^{(128)}$  on  $\{1, 2, \dots, 30\}$  are  $\{1, 9\}$ ,  $\{2, 5, 7, 8, 11, 15, 19, 29\}$ ,  $\{3, 4, 16, 26\}$ , and  $\{6, 20, 27, 24, 23, 17, 14, 13, 25, 10, 21, 30, 28, 12, 18, 22\}$ . We choose a representative from each orbit, find the double costs to which  $N t_1 t_2 t_8 t_i$  belongs to each  $i \in \{1, 3, 6, 8\}$ .

- $N t_1 t_2 t_8 \cdot t_1 = N t_1 t_2 t_8 t_1$ . This gives the relation  $t_1 t_2 t_8 t_1 = (y x x^{-2} y x^{-1}) t_2 t_8$ . This double coset will go back to  $[1, 4]$ . Since there are two elements in this orbit, there are 2  $t'_i$ s that take  $[1, 2, 8]$  to  $[1, 4]$ .

- $Nt_1t_2t_8 \cdot t_3 = Nt_1t_2t_8t_3$ . This gives the relation  $t_1t_2t_8t_3 = t_1t_{26}$ . This double coset will go back to  $[1, 3]$ . Since there are 4 elements in this orbit, there are 4  $t'_i$ s that take  $[1, 2, 8]$  to  $[1, 3]$ .
- $Nt_1t_2t_8 \cdot t_8 = Nt_1t_2t_8^2 = Nt_1t_2 \in [1, 2]$ . This double coset will go back to  $[1, 2]$ . Since there are 8 elements in this orbit, there are 8  $t'_i$ s that take  $[1, 2, 8]$  to  $[1, 2]$ .
- $Nt_1t_2t_8 \cdot t_6 = Nt_1t_2t_8t_6$ . This gives the relation  $t_1t_2t_4t_5 = (xyx^{-2}yx^{-1})t_9t_{22}$ . This double coset will go back to  $[1, 2]$ . Since there are 16 elements in this orbit, there are 16  $t'_i$ s that take  $[1, 2, 8]$  to  $[1, 2]$ .

(iv) We are at a new double coset  $[1, 2, 17]$ ,  $Nt_1t_2t_{17}N = \{N(t_1t_2t_{17})^n | n \in N\}$ .

Now, to determine all the single cosets of this double cosets, we need to determine the point stabilizer  $N^{1217}$ , this means finding the set of elements that fix 1, 2, and 17 in  $N$  and permute the rest of the elements in the set  $\{1, 2, \dots, 30\}$ . The coset stabilizer of the coset  $Nt_1t_2t_{17}$  is  $N^{(1217)} = \{n \in N | (t_1t_2t_{17})^n = t_1t_2t_{17}\}$

$$= \langle (1, 28, 4, 13)(2, 16)(3, 5, 29, 21)(6, 9)(7, 26, 17, 11) \\ (8, 20)(10, 22, 24, 18)(12, 23, 27, 19)(14, 15, 25, 30) \rangle.$$

Since  $|N^{(1217)}| = 4$  then the number of single cosets in  $[1, 2, 17]$  is  $\frac{|N|}{|N^{(1217)}|} = \frac{720}{4} = 180$ . Now, the orbits of  $N^{(1217)}$  on  $\{1, 2, \dots, 30\}$  are  $\{1, 28, 4, 13\}$ ,  $\{2, 16\}$ ,  $\{3, 5, 29, 21\}$ ,  $\{6, 9\}$ ,  $\{7, 11, 26, 17\}$ ,  $\{8, 20\}$ ,  $\{10, 24, 22, 18\}$ ,  $\{12, 27, 23, 19\}$ , and  $\{14, 25, 15, 30\}$ . We choose a representative from each orbit, find the double costs to which  $Nt_1t_2t_{17}t_i$  belongs to each  $i \in \{1, 2, 3, 6, 8, 10, 12, 14, 17\}$ .

- $Nt_1t_2t_{17} \cdot t_1 = Nt_1t_2t_{17}t_1$ . This gives the relation  $t_1t_2t_{17}t_1 = (x^3y^{-1}x)t_9t_{20}t_8$ . This double coset will go to  $[1, 2, 4]$ . Since there are 4 elements in this orbit, there are 4  $t'_i$ s that take  $[1, 2, 17]$  to  $[1, 2, 4]$ .
- $Nt_1t_2t_{17} \cdot t_2 = Nt_1t_2t_{17}t_2$ . This gives the relation  $t_1t_2t_{17}t_2 = (xy^{-1}x^4y)t_9t_6t_8$ . This double coset will go to  $[1, 2, 4]$ . Since there are 2 elements in this orbit, there are 2  $t'_i$ s that take  $[1, 2, 17]$  to  $[1, 2, 4]$ .
- $Nt_1t_2t_{17} \cdot t_3 = Nt_1t_2t_{17}t_3$ . This gives the relation  $t_1t_2t_{17}t_3 = (xyx^4)t_{28}t_{16}$ . This double coset will go back to  $[1, 2]$ . Since there are 4 elements in this orbit, there are 4  $t'_i$ s that take  $[1, 2, 17]$  to  $[1, 2]$ .

- $Nt_1t_2t_{17} \cdot t_6 = Nt_1t_2t_{17}t_6$ . This gives the relation  $t_1t_2t_{17}t_6 = (xy^{-1}x^{-2}y^{-1})t_6t_{10}t_{13}$ . This double coset will send to  $[1, 2, 3]$ . Since there are 2 elements in this orbit, there are 2  $t'_i$ s that take  $[1, 2, 17]$  to  $[1, 2, 3]$ .
- $t_1t_2t_{17} \cdot t_{17} = Nt_1t_2t_{17}^2 = Nt_1t_2 \in [1, 2]$ . This double coset will go back to  $[1, 2]$ . Since there are 4 elements in this orbit, there are 4  $t'_i$ s that take  $[1, 2, 17]$  to  $[1, 2]$ .
- $Nt_1t_2t_{17} \cdot t_8 = Nt_1t_2t_{17}t_8$ . This gives the relation  $t_1t_2t_{17}t_8 = (y^3xy)t_9t_{22}t_1$ . This double coset will send to  $[1, 2, 3]$ . Since there are 2 elements in this orbit, there are 2  $t'_i$ s that take  $[1, 2, 17]$  to  $[1, 2, 3]$ .
- $Nt_1t_2t_{17} \cdot t_{10} = Nt_1t_2t_{17}t_{10}$ . This gives the relation  $t_1t_2t_{17}t_{10} = (xyx^{-1}yx)t_8t_1t_{22}$ . This double coset will send to  $[1, 2, 3]$ . Since there are 4 elements in this orbit, there are 4  $t'_i$ s that take  $[1, 2, 17]$  to  $[1, 2, 3]$ .
- $Nt_1t_2t_{17} \cdot t_{12} = Nt_1t_2t_{17}t_{12}$ . This gives the relation  $t_1t_2t_{17}t_{12} = (y^2x^{-1}y^{-1}x)t_7t_2t_4$ . This double coset will collapse. Since there are 4 elements in this orbit, there are 4  $t'_i$ s that take  $[1, 2, 17]$  to  $[1, 2, 17]$ .
- $Nt_1t_2t_{17} \cdot t_{14} = Nt_1t_2t_{17}t_{14}$ . This gives the relation  $t_1t_2t_{17}t_{14} = (y^2x^{-1}y^{-1}x^{-1})t_{17}t_2t_1$ . This double coset will collapse. Since there are 4 elements in this orbit, there are 4  $t'_i$ s that take  $[1, 2, 17]$  to  $[1, 2, 17]$ .

(v) We are at a new double coset  $[1, 4, 16]$ ,  $Nt_1t_4t_{16}N = \{N(t_1t_4t_{16})^n | n \in N\}$ . Now, to determine all the single cosets of this double cosets, we need to determine the point stabilizer  $N^{1416}$ , this means finding the set of elements that fix 1, 4, and 16 in  $N$  and permute the rest of the elements in the set  $\{1, 2, \dots, 30\}$ . The coset stabilizer of the coset  $Nt_1t_4t_{16}$  is  $N^{(1416)} = \{n \in N | (t_1t_4t_{16})^n = t_1t_4t_{16}\}$

$$\begin{aligned}
&= \langle (1, 2, 4, 8)(3, 6, 11, 18, 26, 20, 29, 22)(5, 10, 17, 12, \\
&\quad 19, 28, 30, 25)(7, 13, 21, 27, 15, 24, 23, 14)(9, 16), \\
&(1, 3, 7, 14, 23, 29, 4, 9)(2, 5, 10, 6, 12, 20, 28, 30) \\
&\quad (8, 15, 25, 21)(11, 16, 26, 19, 13, 22, 24, 17)(18, 27) \rangle.
\end{aligned}$$

Since  $|N^{(1416)}| = 720$  then the number of single cosets in  $[1, 4, 16]$  is  $\frac{|N|}{|N^{(1416)}|} = \frac{720}{720} = 1$ . Now, the orbits of  $N^{(1416)}$  on  $\{1, 2, \dots, 30\}$  is  $\{1, 2, \dots, 30\}$ . We choose a representative from the orbit, and determine the double costs to which  $Nt_1t_4t_{16}t_{16}$  belongs.

- $Nt_1t_4t_{16} \cdot t_{16} = Nt_1t_4t_{16}^2 = Nt_1t_4 \in [1, 4]$ . This double coset will go back to  $[1, 4]$ .  
Since there are 30 elements in this orbit, there are 30  $t'_i$ s that take  $[1, 2, 16]$  to  $[1, 4]$ .

**Conclusion:**

The double coset enumeration gives that

$$\begin{aligned}
 |G| &\leq (|N| + |Nt_1N| + |Nt_1t_2N| + |Nt_1t_3N| + |Nt_1t_4N| + |Nt_1t_2t_3N| + |Nt_1t_2t_4N| + \\
 &|Nt_1t_2t_8N| + |Nt_1t_2t_{17}N| + |Nt_1t_4t_{16}N|) \times |N| \\
 &= (1 + 30 + 360 + 45 + 30 + 360 + 180 + 45 + 180 + 1) \times 720 \\
 &= (1232 \times 720) = 887040. \text{ A Cayley diagram of } G \text{ over } S_6 \text{ is given below.}
 \end{aligned}$$



## 8.2 Factor $M_{22} \times 2$ By It's Center

By using Magma we have the center of  $G$  is

$$x^2 * t * x^{-1} * y * t * y^{-1} * x^{-1} * t = 1 \Rightarrow t_4 t_{16} t_1 = 1.$$

$$\Rightarrow \frac{2^{*30} : S_6}{((x)t_4 t_{23} t_{13} t_{15} t_{14}), ((x)^4 t_{16} t_9 t_{16} t_9), (t_4 t_{16} t_1)} \cong M_{22}.$$

**Using computer-based program - MAGMA extensively through this DCE:**

1. The order of the group,  $|G|$  is equal to 443520 .
2. There are 5 double cosets in this double coset enumeration of  $M_{22}$  over  $S_6$ .

### Relations

We see that new relation

$$(III) (t_4 t_{16} t_1 = 1).$$

Moreover, if we conjugate the previous relation by all elements in  $S_6$ , therefore, the different cosets we obtain

- $(t_2 t_9 t_8 = 1).$
- $(t_9 t_{26} t_3 = 1).$
- $:$
- $:$
- $(t_{20} t_{30} t_{19} = 1).$

### Double Coset Enumeration of $M_{22}$ over $S_6$ :

#### Double Coset $[*]$ :

We start with the double coset  $NeN$ , where  $e$  is the word of length zero, denoted by  $[*]$ .

We have

$$NeN = \{Nen : n \in N\} = \{Ne\} = \{N\}$$

So, the double coset  $NeN$  consists of the single coset  $N$ . Thus,  $\frac{|N|}{|N|} = \frac{720}{720} = 1$ .

Note, since  $N$  is transitive on  $\{1, 2, \dots, 30\}$ , we take a representative coset  $N$  from  $[*]$  and a representative from  $\{1, 2, \dots, 30\}$  and determine the double coset to which  $Nt_i$  belongs, where  $i \in \{1, 2, \dots, 30\}$ . We consider  $i = 1$ , so  $Nt_1$  is the representative coset, and hence



we will have a new double coset  $Nt_1N$  which can be denoted by [1]. There will be 30 possibilities  $t_i$ s that take  $N$  to the next double cosets [1].

### Word of Length One [1]

We consider the double coset  $NwN$ , where  $w$  is a word of length one.

$Nt_1N = \{Nt_1^n | n \in N\} = [1]$ . So,  $Nt_1N = [1]$

$= \{Nt_1^n | n \in N\} = \{Nt_1N, Nt_2N, \dots, Nt_{30}N\}$ . The coset stabilizer of the coset  $Nt_1$  is

$N^{(1)} = \{n \in N | t_1^n = t_1\}$

$$\begin{aligned}
 &= \langle (3, 26)(5, 19)(6, 20)(7, 15)(10, 28)(11, 29)(12, 25)(13, 24) \\
 &\quad (14, 27)(17, 30)(18, 22)(21, 23), \\
 &\quad (2, 12)(4, 15)(5, 16)(6, 22)(8, 28)(9, 26)(11, 24)(13, 14) \\
 &\quad (17, 18)(20, 30)(21, 23)(27, 29), \\
 &\quad (2, 27)(4, 5)(6, 21)(8, 24)(9, 26)(10, 25)(11, 28)(12, 29) \\
 &\quad (15, 16)(17, 30)(18, 20)(22, 23) \rangle
 \end{aligned}$$

Since  $|N^{(1)}| = 24$ , the number of single cosets in [1] is  $\frac{|N|}{|N^{(1)}|} = \frac{720}{24} = 30$ .

Now, the orbits of  $N^{(1)}$  on  $\{1, 2, \dots, 30\}$  are  $\{1\}$ ,  $\{2, 12, 27, 25, 29, 14, 10, 11,$

$13, 28, 24, 8\}$ ,  $\{3, 26, 9\}$ ,  $\{4, 15, 5, 7, 16, 19\}$  and  $\{6, 20, 22, 21, 30, 18, 23, 17\}$ . We choose a

representative from each orbit, find the double cosets to which  $Nt_1t_i$  belongs to each  $i \in \{1, 2, 3, 4, 6\}$ .

- $Nt_1 \cdot t_1 = Nt_1^2 = N \in [*]$ . This will go back to  $[*]$ . Since there is one element in this orbit, there is one  $t_i$  that takes [1] to  $[*]$ .
- $Nt_1 \cdot t_2 = Nt_1t_2 \in [12]$ . This is a new double coset, which will extend the Cayley graph from [1] to [12]. Since there are 12 elements in this orbit, there are 12  $t'_i$ s that take [1] to [12].
- $Nt_1 \cdot t_3 = Nt_1t_3 \in [13]$ . This is a new double coset, which extends our graph from [1] to [13]. Since there are 3 elements in this orbit, there are 3  $t'_i$ s that take [1] to [13].
- $Nt_1 \cdot t_4 = Nt_1t_4 = Nt_{16} \in [1]$ . This double coset will collapse. Since there are 6 elements in this orbit, there are 6  $t'_i$ s that take [1] to [1].
- $Nt_1 \cdot t_6 = Nt_1t_6 = Nt_{22} \in [1]$ . This double coset will collapse. Since there are 8 elements in this orbit, there are 8  $t'_i$ s that take [1] to [1].

### Word of Length Two [12], and [13]

(i) We are at a new double coset [12],  $Nt_1t_2N = \{N(t_1t_2)^n | n \in N\}$ . The coset stabilizer of the coset  $Nt_1t_2$  is  $N^{(12)} = \{n \in N | (t_1t_2)^n = t_1t_2\}$

$$= \langle (3, 26)(5, 19)(6, 20)(7, 15)(10, 28)(11, 29)(12, 25)(13, 24) \\ (14, 27)(17, 30)(18, 22)(21, 23) \rangle.$$

Since  $|N^{(12)}| = 2$  then the number of single cosets in [12] is  $\frac{|N|}{|N^{(12)}|} = \frac{720}{2} = 360$ .

Now, the orbits of  $N^{(12)}$  on  $\{1, 2, \dots, 30\}$  are  $\{1\}, \{2\}, \{3, 26\}, \{4\}, \{5, 19\}, \{6, 20\}, \{7, 15\}, \{8\}, \{9\}, \{10, 28\}, \{11, 29\}, \{12, 25\}, \{13, 24\}, \{14, 27\}, \{16\}, \{17, 30\}, \{18, 22\},$  and  $\{21, 23\}$ . We choose a representative from each orbit, and determine the double costs to which  $Nt_1t_2t_i$ ,

where  $i \in \{1, 2, 3, 4, 5, 6, 7, 8, 9, 10, 11, 12, 13, 14, 16, 17, 18, 21\}$  belongs.

- $Nt_1t_2 \cdot t_1 = Nt_1t_2t_1$ . This gives the relation  $t_1t_2t_1 = (yx^{-2}y)t_1t_2t_4$ . This double coset will go to  $[1, 2, 4]$ . Since there is one element in this orbit, there is one  $t_i$  that takes [12] to  $[1, 2, 4]$ .
- $Nt_1t_2 \cdot t_2 = Nt_1t_2^2 \in [1]$ . This will go back to [1]. Since there is one element in this orbit, there is one  $t_i$  that takes [12] to [1].
- $Nt_1t_2 \cdot t_3 = Nt_1t_2t_3$ . This gives the relation  $t_1t_2t_3 = t_1t_{11}$ . This double coset will collapse. Since there are 2 elements in this orbit, there are 2  $t'_i$ s that take [12] to [12].
- $Nt_1t_2 \cdot t_4 = Nt_1t_2t_4 \in [124]$ . This is a new double coset, which extends our graph from [12] to [124]. Since there is one element in this orbit, there is one  $t_i$  that takes [12] to [124].
- $Nt_1t_2 \cdot t_5 = Nt_1t_2t_5$ . This gives the relation  $t_1t_2t_5 = (xy^{-1}x^{-2}y^{-1})t_{20}t_9$ . This double coset will collapse. Since there are 2 elements in this orbit, there are 2  $t'_i$ s that take [12] to [12].
- $Nt_1t_2 \cdot t_6 = Nt_1t_2t_6$ . This gives the relation  $t_1t_2t_6 = (y^{-1} * x^{-1} * y^2)^2t_4t_2$ . This double coset will collapse. Since there are 2 elements in this orbit, there are 2  $t'_i$ s that take [12] to [12].

- $Nt_1t_2 \cdot t_7 = Nt_1t_2t_7$ . This gives the relation  $t_1t_2t_7 = (yxyx^{-1}y^{-2}x)t_6t_9$ . This double coset will collapse. Since there are 2 elements in this orbit, there are 2  $t'_i$ s that take [12] to [12].
- $Nt_1t_2 \cdot t_8 = Nt_1t_2t_8$ . This gives the relation  $t_1t_2t_8 = t_1t_9$ . This double coset will send to [13]. Since there is one element in this orbit, there is one  $t_i$  that takes [12] to [13].
- $Nt_1t_2 \cdot t_9 = Nt_1t_2t_9$ . This gives the relation  $t_1t_2t_9 = t_1t_8$ . This double coset will collapse. Since there is one element in this orbit, there is one  $t_i$  that takes [12] to [12].
- $Nt_1t_2 \cdot t_{10} = Nt_1t_2t_{10}$ . This gives the relation  $t_1t_2t_{10} = t_1t_{24}$ . This double coset will collapse. Since there are 2 elements in this orbit, there are 2  $t'_i$ s that take [12] to [12].
- $Nt_1t_2 \cdot t_{11} = Nt_1t_2t_{11}$ . This gives the relation  $t_1t_2t_{11} = t_1t_3$ . This double coset will send to [13]. Since there are 2 elements in this orbit, there are 2  $t'_i$ s that take [12] to [13].
- $Nt_1t_2 \cdot t_{12} = Nt_1t_2t_{12}$ . This gives the relation  $t_1t_2t_{12} = t_1t_{25}$ . This double coset will collapse. Since there are 2 elements in this orbit, there are 2  $t'_i$ s that take [12] to [12].
- $Nt_1t_2 \cdot t_{13} = Nt_1t_2t_{13}$ . This gives the relation  $Nt_1t_2t_{13} = t_1t_{28}$ . This double coset will collapse. Since there are 2 elements in this orbit, there are 2  $t'_i$ s that take [12] to [12].
- $Nt_1t_2 \cdot t_{14} = Nt_1t_2t_{14}$ . This gives the relation  $t_1t_2t_{14} = t_1t_{27}$ . This double coset will collapse. Since there are 2 elements in this orbit, there are 2  $t'_i$ s that take [12] to [12].
- $Nt_1t_2 \cdot t_{16} = Nt_1t_2t_{16}$ . This gives the relation  $t_1t_2t_{16} = (y*x^{-2}*y)t_1t_2$ . This double coset will collapse. Since there is one element in this orbit, there is one  $t_i$  that takes [12] to [12].

- $Nt_1t_2 \cdot t_{17} = Nt_1t_2t_{17}$ . This gives the relation  $t_1t_2t_{17} = t_{14}t_{16}t_{12}$ . This double coset will send to [124]. Since there are two elements in this orbit, there are 2  $t_i$  that take [12] to [124].
- $Nt_1t_2 \cdot t_{18} = Nt_1t_2t_{18}$ . This gives the relation  $t_1t_2t_{18} = (yxy^{-2})^2t_4t_2t_1$ . This double coset will send to [1, 2, 4]. Since there are two elements in this orbit, there are 2  $t'_i$ s that take [1, 2] to [1, 2, 4].
- $Nt_1t_2 \cdot t_{21} = Nt_1t_2t_{21}$ . This gives the relation  $t_1t_2t_{21} = (x * y^{-1} * x^{-2} * y^{-1})t_6t_9t_{20}$ . This double coset will send to [124]. Since there are 2 elements in this orbit, there are 2  $t'_i$ s that take [12] to [124].

(ii) We are at a new double coset [13],  $Nt_1t_3N = \{N(t_1t_3)^n | n \in N\}$ . The coset stabilizer of the coset  $Nt_1t_3$  is  $N^{(13)} = \{n \in N | (t_1t_3)^n = t_1t_3\}$

$$= < (2, 12)(4, 15)(5, 16)(6, 22)(8, 28)(9, 26)(11, 24)(13, 14) \\ (17, 18)(20, 30)(21, 23)(27, 29), \\ (2, 27)(4, 5)(6, 21)(8, 24)(9, 26)(10, 25)(11, 28)(12, 29) \\ (15, 16)(17, 30)(18, 20)(22, 23), \\ (2, 11)(4, 16)(6, 30)(7, 19)(8, 29)(10, 13)(12, 28)(14, 25) \\ (17, 22)(18, 23)(20, 21)(24, 27), \\ (1, 3)(2, 20, 24, 23, 29, 17, 28, 6)(4, 25, 5, 13, 16, 10, \\ 15, 14)(7, 9, 19, 26)(8, 30, 27, 22, 11, 18, 12, 21) >.$$

Since  $|N^{(13)}| = 16$  then the number of single cosets in [13] is  $\frac{|N|}{|N^{(13)}|} = \frac{720}{16} = 45$ .

Now, the orbits of  $N^{(13)}$  on  $\{1, 2, \dots, 30\}$  are  $\{1, 3\}$ ,  $\{2, 12, 27, 11, 20, 21, 22, 17, 18, 6, 23, 30, 29, 28, 24, 8\}$ ,  $\{4, 15, 5, 16, 25, 14, 13, 10\}$ , and  $\{7, 19, 9, 26\}$ . We choose a representative from each orbit, and find the double costs to which  $Nt_1t_3t_i$  belongs to each  $i \in \{2, 3, 4, 7\}$ .

- $Nt_1t_3 \cdot t_3 = Nt_1t_3^2 \in [1]$ . This will go back to [1]. Since there are two elements in this orbit, there are 2  $t'_i$ s that take [1, 3] to [1].
- $Nt_1t_3 \cdot t_2 = Nt_1t_3t_2$ . This gives the relation  $Nt_1t_3t_2 = t_1t_{11}$ . This double coset will send to [12]. Since there are 16 elements in this orbit, there are 16  $t'_i$ s that take [13] to [12].
- $Nt_1t_3 \cdot t_4 = Nt_1t_3t_4$ . This gives the relation  $t_1t_3t_4 = (y^2 * x^2 * y * x)t_3t_{16}$ . This double coset will send to [12]. Since there are 8 elements in this orbit, there are 8  $t'_i$ s that take [13] to [12].

- $Nt_1t_3 \cdot t_7 = Nt_1t_3t_7$ . This gives the relation  $t_1t_3t_7 = (x * y * x * y * x^{-1} * y^{-1})t_1t_3$ . This double coset will collapse. Since there are 4 elements in this orbit, there are 4  $t'_i$ s that take [13] to [13].

**Word of Length Three [124]:**

We are at a new double coset [124],  $Nt_1t_2t_4N = \{N(t_1t_2t_4)^n | n \in N\}$ . Now, the coset stabilizer of the coset  $Nt_1t_2t_4$  is  $N^{(124)} = \{n \in N | (t_1t_2t_4)^n = t_1t_2t_4\}$

$$= \langle (1, 2)(3, 6, 26, 20)(4, 8)(5, 24, 19, 13)(7, 28, 15, 10) \\ (9, 16)(11, 22, 29, 18)(12, 23, 25, 21)(14, 17, 27, 30) \rangle.$$

$N^{(124)}$  generated by 4 elements.

Since  $|N^{(124)}| = 4$  then the number of single cosets in [124] is  $\frac{|N|}{|N^{(124)}|} = \frac{720}{4} = 180$ .

Now, the orbits of  $N^{(124)}$  on  $\{1, 2, \dots, 30\}$  are  $\{1, 2\}$ ,  $\{4, 8\}$ ,  $\{9, 16\}$ ,  $\{3, 26, 6, 20\}$ ,  $\{5, 15, 24, 13\}$ ,  $\{7, 15, 28, 10\}$ ,  $\{11, 29, 22, 18\}$ ,  $\{12, 25, 23, 21\}$ ,

and  $\{14, 27, 17, 30\}$ . We choose a representative from each orbit, and determine the double costs to which  $Nt_1t_2t_4t_i$  belongs to each

$i \in \{1, 3, 4, 5, 7, 9, 11, 12, 14\}$ .

- $Nt_1t_2t_4 \cdot t_1 = Nt_1t_2t_4t_1$ . This gives the relation  $t_1t_2t_4t_1 = (yx^{-2}y)t_1t_2$ . This double coset will go back to [1, 2]. Since there are two elements in this orbit, there are 2  $t'_i$ s that take [1, 2, 4] to [1, 2].
- $Nt_1t_2t_4 \cdot t_3 = Nt_1t_2t_4t_3$ . This gives the relation  $t_1t_2t_4t_3 = (x^2 * y^{-1} * x^{-2} * y^{-1} * x^{-2})t_8t_1t_2$ . This double coset will collapse. Since there are 4 elements in this orbit, there are 4  $t'_i$ s that take [124] to [124].
- $Nt_1t_2t_4 \cdot t_4 = Nt_1t_2t_4^2 = Nt_1t_2 \in [1, 2]$ . This double coset will go back to [1, 2]. Since there are 2 elements in this orbit, there are 2  $t'_i$ s that take [1, 2, 4] to [1, 2].
- $Nt_1t_2t_4 \cdot t_5 = Nt_1t_2t_4t_5$ . This gives the relation  $t_1t_2t_4t_5 = (y * x * y^{-2} * x * y * x^{-1})t_{20}t_9$ . This double coset will go back to [12]. Since there are 4 elements in this orbit, there are 4  $t'_i$ s that take [124] to [12].
- $t_1t_2t_4 \cdot t_7 = Nt_1t_2t_4t_7$ . This gives the relation  $t_1t_2t_4t_7 = ((y * x * y * x^{-1} * y^{-1})^3)t_{20}t_9$ . This double coset will go back to [12]. Since there are 4 elements in this orbit, there are 4  $t'_i$ s that take [124] to [12].

- $Nt_1t_2t_4 \cdot t_9 = Nt_1t_2t_4t_9$ . This gives the relation  $t_1t_2t_4t_9 = (x^2 * y * x^{-2} * y)t_1t_2t_4$ . This double coset will collapse. Since there are 2 elements in this orbit, there are 2  $t'_i$ s that take [124] to [124].
- $Nt_1t_2t_4 \cdot t_{11} = Nt_1t_2t_4t_{11}$ . This gives the relation  $t_1t_2t_4t_{11} = (x^2y^{-1}x^{-2}y^{-1}x^{-2})t_8t_1$ . This double coset will go back to [12]. Since there are 4 elements in this orbit, there are 4  $t'_i$ s that take [124] to [12].
- $Nt_1t_2t_4 \cdot t_{12} = Nt_1t_2t_4t_{12}$ . This gives the relation  $t_1t_2t_4t_{12} = (x^{-2}y^{-1})t_{16}t_3t_4$ . This double coset will collapse. Since there are 4 elements in this orbit, there are 4  $t'_i$ s that take [124] to [124].
- $Nt_1t_2t_4 \cdot t_{14} = Nt_1t_2t_4t_{14}$ . This gives the relation  $t_1t_2t_4t_{14} = (yx^2)t_{16}t_{26}t_4$ . This double coset will collapse. Since there are 4 elements in this orbit, there are 4  $t'_i$ s that take [124] to [124].

**Conclusion:**

The double coset enumeration gives that

$$\begin{aligned}
|G| &\leq (|N| + |Nt_1N| + |Nt_1t_2N| + |Nt_1t_3N| + |Nt_1t_2t_4N|) \times |N| \\
&= (1 + 30 + 360 + 45 + 180) \times 720 \\
&= (616 \times 720) = 443520. \text{ A Cayley diagram of } G \text{ over } S_6 \text{ is given below.}
\end{aligned}$$

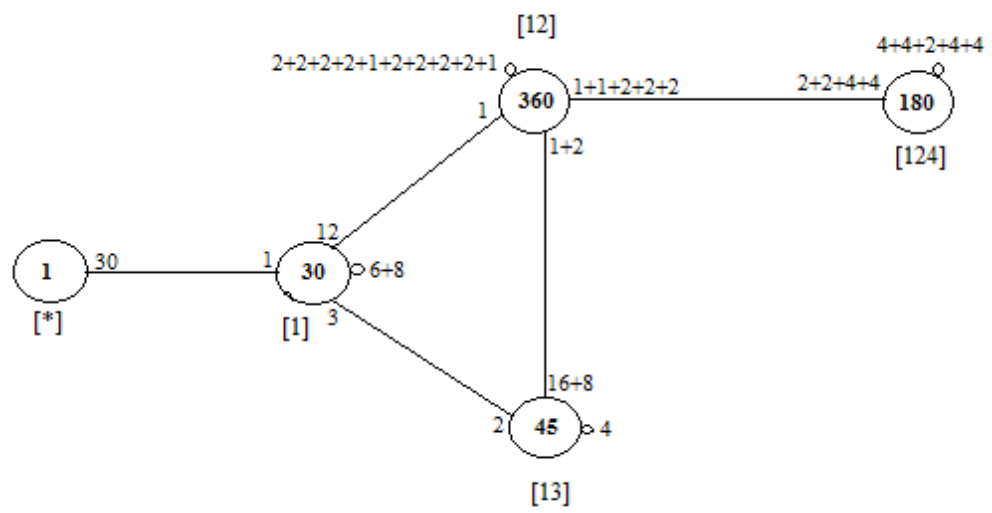
Figure 8.2: Cayley Diagram for  $M_{22}$  Over  $S_6$

## Chapter 9

# Group Representation and Character Theory

### 9.1 Group Representation

The main reason to study the group representations is to simplify the study of groups. Representation theory shows how we can study groups by reducing many group theoretic problems to basic linear algebra calculations. In order to define the group representation we define groups, homomorphism, automorphism, the general linear group, and the module theory in the first chapter.

**Definition 9.1.** Let  $F$  be a field and let  $A$  be an  $F$ -vector space which is also a ring with 1. Suppose for all  $c \in F$  and  $x, y \in A$ , that  $(cx)y = c(xy) = x(cy)$ . Then  $A$  is an  **$F$ -algebra**.

**Definition 9.2.** Let  $A$  be a  $F$ -algebra. A **representation** of  $A$  is an algebra homomorphism  $\mathfrak{X} : A \rightarrow M_n(F)$ . The integer  $n$  is the **degree** of  $\mathfrak{X}$ . Two representations  $\mathfrak{X}, \mathfrak{D}$  of degree  $n$  are similar if there exists a nonsingular  $n \times n$  matrix  $P$ , such that  $\mathfrak{X}(a) = P^{-1}\mathfrak{D}(a)P$  for all  $a \in A$ .

**Definition 9.3.** Let  $F$  be a field and  $G$  a group. Then a  **$F$ -representation** of  $G$  is a homomorphism  $\chi : G \rightarrow GL(n, F)$  for some integer  $n$ .



**Definition 9.4.** In a linear representation, let  $K$  be field and  $G$  be a group, and let the function  $\lambda$  send the group  $G$  to the field  $K$ , then every group possesses the **trivial or principle representation** given by the constant function  $\lambda(x) = 1; x \in G$ .

**Definition 9.5.** The matrix representation  $N(x)$  is **permutation matrix**, that is it has exactly one unite in each row and in each column.

**Definition 9.6.** The representation is **injective or faithful** if and only if the kernel reduces to the trivial group  $\{1\}$ .

**Example 9.7.** Let  $A(x)$  and  $A(y)$  be matrices representation of group  $G$  of degree (dimension)  $m$  over  $K$ , which  $K$  is a field. Then the equation  $A(x) = A(y) \Rightarrow A(x)(A(y))^{-1} = A(y)(A(y))^{-1} \Rightarrow A(x)(A(y))^{-1} = I \Rightarrow A(xy^{-1}) = I$ , for the faithful representation that implies  $xy^{-1} = 1$ , that is  $x = y$ .

**Definition 9.8.** Let  $G$  be a group. The vector space  $V$  over  $K$  is called a  **$G$ -module**, if a multiplication  $vx (v \in V, x \in G)$  is defined, subject to the rules:

1.  $vx \in V$ ;
2.  $(hv + kw)x = h(vx) + k(wx), (v, w \in V; h, k \in K)$ ;
3.  $v(xy) = (vx)y$ ;
4.  $v1 = v$ .

**Definition 9.9.** Let  $V$  be a  $G$ -module over  $k$ . We say that  $U$  is a **submodule** of  $V$  if

1.  $U$  is a vector space (over  $K$ ) contained in  $V$ , and
2.  $U$  is a  $G$ -module, that is  $ux \in U$  for all  $u \in U$  and  $x \in G$ .

Every  $G$ -module  $V$  possesses the trivial submodules  $U = V$  and  $U = 0$ . A non-trivial submodule is also called a **proper submodule**.

**Definition 9.10.** Let  $V$  be a nonzero  $A$ -module. Then  $V$  is *irreducible* if and only if submodules (subrepresentation) are  $0$  and  $V$ .

**Theorem 9.11.** (Maschkes Theorem)

Let  $G$  be a finite group and  $F$  a field whose characteristic can not divide  $|G|$ . Then every  $F[G]$ -module is completely reducible.

## 9.2 Character Theory

In this section we will determinate a representation by its character which is important for the study of finite group representations. In order to define the character and find the character table we will define the conjugacy classes of the group. We will find that there is a intimate relation between the character of a representation and the conjugacy classes of the group.

**Definition 9.12.** Let  $a$  and  $b$  be elements of a group  $G$ . We say that  $a$  and  $b$  are *conjugate* in  $G$  (and call  $b$  a conjugate of  $a$ ) if  $xax^{-1} = b$  for some  $x \in G$ . **The conjugacy class** of  $a$  is the set  $cl(a) = \{xax^{-1} | x \in G\}$ .

**Note:** We can define the conjugate in  $G$  for  $a$  and  $b$  by  $a^x = xax^{-1} = b; \forall x \in G$ , and the order of  $a^x$  is equal to the order of  $a$ .

**Example 9.13.** We will find the conjugacy classes of the symmetric group  $S_3$ . As we know that  $S_3 = \{e, (12), (13), (23), (123), (132)\}$ , and also we now the definition of the conjugacy classes  $C_i$  of the element  $a$  is the set  $cl(a) = \{xax^{-1} | x \in G\}$ .

So, we will start with  $e$  to find the first class  $C_1$ , suppose  $a = e \Rightarrow cl(e)$

$$= \{eee^{-1}, (12)e(12)^{-1}, (13)e(13)^{-1}, (23)e(23)^{-1}, (123)e(123)^{-1}, (132)e(132)^{-1}\} = \{e\}.$$

$\Rightarrow$  Let  $h_1 = \{e\}$  be  $C_1$ .

Then, to find the second class  $C_2$  we will take the second element which is a 2-cycle, suppose  $a = (12) \Rightarrow cl((12)) = \{e(12)e^{-1}, (12)(12)(12)^{-1}, (13)(12)(13)^{-1},$

$$(23)(12)(23)^{-1}, (123)(12)(123)^{-1}, (132)(12)(132)^{-1}\}$$

$$= \{(12), (23), (13)\} = cl((13)) = cl((23)).$$

$\Rightarrow$  Let  $h_2 = \{(12), (23), (13)\}$  be  $C_2$ .

To find the third class  $C_3$  we will take element with a 3-cycle, suppose  $a = (123) \Rightarrow cl((123)) = \{(123), (132)\} = cl((132)).$

$\Rightarrow$  Let  $h_3 = \{(123), (132)\}$  be  $C_3$ .

To check the work we will add the number of the elements in all classes to get the order of  $S_3$ ,  $h_1 = h_2 = h_3 = 1 + 3 + 2 = 6 = |S_3|$

Thus, we have a table for conjugacy classes ready to use.

Table 9.1: Table for Conjugacy Classes of  $S_3$

$S_3$	Order : Element	Length
$C_1 = \{1\}$	Order1 : 1	1
$C_2 = \{2\}$	Order2 : (12)	3
$C_3 = \{3\}$	Order3 : (123)	2

**Definition 9.14.** If  $a \in G$ , then the **centralizer** of  $a$  in  $G$ , denoted by  $C_G(a)$ , is the set of all  $x \in G$  which commute with  $a$ .

$C_G(a) = \{g \in G | a^g = a\}$ . It is immediate that  $C_G(a)$  is a subgroup of  $G$ .

**Theorem 9.15.** If  $a \in G$ , the number of the conjugates of  $a$  is equal to the index of its centralizer:  $|a^G| = [G : C_G(a)]$ , and this number is divisor of  $|G|$  when  $G$  is finite.

**Example 9.16.** We find the centralizer of  $a = (1, 2, 3, 4, 5, 6, 7, 8, 9)$  in  $D_9$  to illustrate the last theorem.

By using the definition of the centralizer, we have that  $C_G(a) = \{g \in G | a^g = a\} = \{a^e = a^a = a^{a^2} = a^{a^3} = a^{a^4} = a^{a^5} = a^{a^6} = a^{a^7} = a^{a^8} = a\}$

$\Rightarrow C_G(a) = \{e, a, a^2, a^3, a^4, a^5, a^6, a^7, a^8\}$  We note that  $|C_G| = 9$  since the order of  $D_9$  is 18, we have  $\frac{|G|}{|C_G(a)|} = \frac{18}{9} = 2 =$  the number of the conjugates of  $a$ .

**Definition 9.17.** Let  $\mathfrak{X}$  be an  $F$ -representation of  $G$ . Then the **F-character**  $\chi$  of  $G$  afforded by  $\mathfrak{X}$  is the function given by  $\chi(g) = \text{tr}\mathfrak{X}(g)$ ;

where  $\text{tr}\mathfrak{X}(g)$  is the trace of the action of  $g$  on  $\mathfrak{X}$ , and the traces of conjugate matrices are equal.

Note that we call a **character irreducible** if the associated representation is irreducible.

The dimension of the representation which is have the character value at 1 called  $\chi(1)$  is the **degree** of  $\chi$ . We denote that by  $\chi(1) = \text{deg}\mathfrak{X}$ . However, characters of degree 1 are called **linear characters**.

**Definition 9.18.** The **alternating character** of the symmetric group  $S_n$  (for each  $n > 1$ ) defined by

$$\xi(x) = \begin{cases} 1 & \text{if } x \text{ is even} \\ -1 & \text{if } x \text{ is odd} \end{cases}$$

**Lemma 9.19.** (a) Similar  $F$ -representation of  $G$  afford equal characters.

(b) Characters are constant on the conjugacy classes of a group.

**Corollary 9.20.** The number  $k$  of the similarity classes of irreducible representation of  $G$  is equal to the number of conjugacy classes of  $G$ .

**Corollary 9.21.** The group  $G$  is abelian iff every irreducible character is linear.

**Theorem 9.22.** (Character relations of the first kind)

Let  $\chi(x)$  and  $\hat{\chi}(x)$  be the characters of the irreducible representations  $A(x)$  and  $B(x)$ , respectively. Then

$$\langle \chi, \hat{\chi} \rangle = \begin{cases} 1 & \text{if } A(x) \sim B(x) \\ 0 & \text{if } A(x) \not\sim B(x) \end{cases}$$

### 9.3 Character Table

In this part we will find the character table for some groups by using some of the definitions and theorems we mentioned before and using the conjugacy class for each irreducible character.

**Definition 9.23.** The character table is a square array of complex numbers whose rows correspond to the  $\chi_i$  and whose columns correspond to the classes  $\mathfrak{X}_i$ .

**Theorem 9.24.** Let  $G$  be a group of order  $g$ . If  $G$  has  $k$  conjugacy classes, there are, up to equivalence,  $k$  distinct irreducible representation over  $C$ ,  $F^{(1)}, F^{(2)}, \dots, F^{(k)}$ . If  $F^{(i)}$  is of degree  $f^{(i)}$ , then  $g = \sum_{i=1}^k (f^{(i)})^2$ .

**Theorem 9.25.** Let  $G$  be a finite group having the distinct irreducible characters

$\chi^{(1)}, \chi^{(2)}, \dots, \chi^{(k)}$ . Let  $1 \leq i, j \leq k$ . Then  $\sum_{i=1}^k \chi_{\alpha}^{(i)} \bar{\chi}_{\beta}^{(i)} = \frac{|G|}{h_{\alpha}} \delta_{\alpha\beta}$ .

(a) In a character table, the dot product of any column with the conjugate of any other column is 0.

(b) In a character table, the dot product of the column  $\alpha$  with its own conjugate is  $\frac{|G|}{h_{\alpha}}$ .

**Example 9.26.** *The character table of  $S_3$ .*

*In order to build the character table of the symmetric group  $S_3$  we will use the conjugacy classes and find the three simple characters which are the trivial, alternating, and arbitrary representation. From the conjugacy classes we know that the character table has to be a  $3 \times 3$  matrix, and also we know how we can obtain degrees of unknown characters by squaring the degree from the conjugacy classes and add them together. We know that the trivial representation is a representation that takes every element in  $S_3$  to the identity, so the first row will be the trivial character  $\chi^{(1)}(x)$  which is the identity character. Then, the second row will be alternating representation which means we will look at  $C_i$  then if it even we will get 1 and if it odd we will get -1, so the second row will be  $\chi^{(2)}(x) = 1, -1, 1$ . To illustrate the last character which is the arbitrary representation we will use the last two theorems. The first element of the third row will be  $1^2 + 1^2 + (f^{(3)})^2 = 6 \Rightarrow (f^{(3)})^2 = 4 \Rightarrow f^{(3)} = 2$ . The next two elements  $x$  and  $y$  will be  $(1.1) + (1.(-1)) + (2x) = 0 \Rightarrow 2x = 0 \Rightarrow x = 0$ , and  $(1.1) + (1.(1)) + (2y) = 0 \Rightarrow 2y = -2 \Rightarrow y = -1$ . Then the character table will be,*

Table 9.2: Character Table of  $S_3$

Classes	1	2	3
Size	1	3	2
Order	1	2	3
$\chi^{(1)}$	1	1	1
$\chi^{(2)}$	1	-1	1
$\chi^{(3)}$	2	0	-1

**Example 9.27.** *The conjugacy classes and the character table of  $D_9$ .*

*We now that  $G = D_9 = \{a, b | a^9 = b^2 = e, bab^{-1} = a^{-1}\}$ , so that mean we have  $G = \{e, a, a^2, a^3, a^4, a^5, a^6, a^7, a^8, b, ab, a^2b, a^3b, a^4b, a^5b, a^6b, a^7b, a^8b\}$ . From the definition of  $G$ , we have those  $a^9 = 1 \Rightarrow a^8 = a^{-1}$ ,  $b^2 = 1 \Rightarrow b = b^{-1}$ , and  $b * a * b^{-1} = a^{-1} \Rightarrow ba = a^{-1}b^{-1} \Rightarrow ba = a^8b$ , then let  $a = (1, 2, 3, 4, 5, 6, 7, 8, 9)$  and  $b = (1, 9)(2, 8)(3, 7)(4, 6)$  Now, to find the conjugacy classes of  $G$  We will apply the definition of the conjugacy classes.*

*We will start with  $e$  to find the first class  $C_1$ .  $e^G = \{e^g | g \in G\} = \{geg^{-1} | g \in G\} = \{e\}$ .*

*Let  $d_1 = \{e\}$  be  $C_1$ ;*

*To find the second class  $C_2$  we will take a 2-cycle.  $(b)^G = \{b^g | g \in G\}$*

$$= \{b^e, b^a, b^{a^2}, b^{a^3}, b^{a^4}, b^{a^5}, b^{a^6}, b^{a^7}, b^{a^8}, b^b, b^{ab}, b^{a^2b}, b^{a^3b}, b^{a^4b}, b^{a^5b}, b^{a^6b}, b^{a^7b}, b^{a^8b}\}$$

$$= \{b, a^2b, a^4b, a^6b, a^8b, ab, a^3b, a^5b, a^7b\}.$$

Let  $d_2 = \{b, a^2b, a^4b, a^6b, a^8b, ab, a^3b, a^5b, a^7b\}$  be  $C_2$ ;

To find the third class  $C_3$  we will take a 3-cycle.  $(a^4)^G = \{(a^4)^g | g \in G\}$

$$= \{a^{4e}, a^{4a}, a^{4a^2}, a^{4a^3}, a^{4a^4}, a^{4a^5}, a^{4a^6}, a^{4a^7}, a^{4a^8}, a^{4b}, a^{4ab}, a^{4a^2b}, a^{4a^3b}, a^{4a^4b}, a^{4a^5b}, a^{4a^6b}, a^{4a^7b}, a^{4a^8b}\} = \{a^4, a^5\}.$$

Let  $d_3 = \{a^4, a^5\}$  be  $C_3$  ;

To find the fourth class  $C_4$  we will take a 9-cycle.  $a^G = \{a^g | g \in G\}$

$$= \{a^e, a^a, a^{a^2}, a^{a^3}, a^{a^4}, a^{a^5}, a^{a^6}, a^{a^7}, a^{a^8}, a^b, a^{ab}, a^{a^2b}, a^{a^3b}, a^{a^4b}, a^{a^5b}, a^{a^6b}, a^{a^7b}, a^{a^8b}\}$$

$$= \{a, a^8\}.$$

Let  $d_4 = \{a, a^8\}$  be  $C_4$ ;

To find the fifth class  $C_5$  we will take a 9-cycle.  $(a^2)^G = \{(a^2)^g | g \in G\}$

$$= \{a^{2e}, a^{2a}, a^{2a^2}, a^{2a^3}, a^{2a^4}, a^{2a^5}, a^{2a^6}, a^{2a^7}, a^{2a^8}, a^{2b}, a^{2ab}, a^{2a^2b}, a^{2a^3b}, a^{2a^4b}, a^{2a^5b}, a^{2a^6b}, a^{2a^7b}, a^{2a^8b}\} = \{a^2, a^7\}.$$

Let  $d_5 = \{a^2, a^7\}$  be  $C_5$ ;

Finally, to find the sixth class  $C_6$  we will take a 9-cycle.  $(a^3)^G = \{(a^3)^g | g \in G\}$

$$= \{a^{3e}, a^{3a}, a^{3a^2}, a^{3a^3}, a^{3a^4}, a^{3a^5}, a^{3a^6}, a^{3a^7}, a^{3a^8}, a^{3b}, a^{3ab}, a^{3a^2b}, a^{3a^3b}, a^{3a^4b}, a^{3a^5b}, a^{3a^6b}, a^{3a^7b}, a^{3a^8b}\} = \{a^3, a^6\}.$$

Let  $d_6 = \{a^3, a^6\}$  be  $C_6$ . We will construct the conjugacy classes table of  $D_9$  to be clearly.

Table 9.3: Table of Conjugacy Classes of  $D_9$

$D_9$	Order : Element	Length
$C_1 = \{1\}$	Order1 : e	$d_1 = 1$
$C_2 = \{2\}$	Order2 : (1, 9)(2, 8)(3, 7)(4, 6)	$d_2 = 9$
$C_3 = \{3\}$	Order3 : (1, 4, 7)(2, 5, 8)(3, 6, 9)	$d_3 = 2$
$C_4 = \{4\}$	Order9 : (1, 2, 3, 4, 5, 6, 7, 8, 9)	$d_4 = 2$
$C_5 = \{5\}$	Order9 : (1, 3, 5, 7, 9, 2, 4, 6, 8)	$d_5 = 2$
$C_6 = \{6\}$	Order9 : (1, 5, 9, 4, 8, 3, 7, 2, 6)	$d_6 = 2$

Because we get 6 conjugacy classes, the character table has 6 irreducible characters called by  $\chi^{(1)}, \chi^{(2)}, \dots, \chi^{(6)}$ .

1. As usual the first character  $\chi^{(1)}$  will be the trivial character.
2. We know the order of the normal subgroup of  $D_9$  divides the order of  $D_9$ . The possible order of the normal subgroup other than the identity or the whole group should be 2, 3, 6, 9. We use the right coset to find which order we will use, so we have  $G/N = \frac{G}{\langle a^3 \rangle} = \frac{G}{\{e, a, a^2\}} = \frac{18}{3} = 6$  right cosets. These look at normal

subgroup of order 6 to use it to find the first two nontrivial characters. We will chose  $S_3$  to be the normal subgroup of order 6. Since we know the character table of  $S_3$ ,

Classes $C'_\alpha$	1	(1,2)	(1,2,3)
Size $h_\alpha$	1	3	2
$\phi^{(2)}$	1	-1	1
$\phi^{(3)}$	2	0	-1

- We will use the alternation character to fill the irreducible character  $\chi^{(2)}$ .

$$\chi^{(2)} = 1, -1, 1, 1, 1, 1$$

- We will use this method  $\langle \phi^G, \phi^G \rangle_G$  to fill the irreducible character  $\chi^{(3)}$ . We construct the induced character  $\phi^G$  with the definition;

$$\phi_\alpha^G = \frac{[G : S_3]}{h_\alpha} \sum_w \phi(w), (w \in C_\alpha \cap S_3)$$

Going through the six classes of  $G$  we obtain that

$$\begin{aligned} 1) \phi_1^G &= \frac{3}{1} \sum_1 \phi(1) = \frac{3}{1} \times 1 = 3. \\ 2) \phi_2^G &= \frac{3}{9} \sum_b \phi(b) = \frac{3}{9} \times (3 \times -1) = -1. \\ 3) \phi_3^G &= \frac{3}{2} \sum_a \phi(a^4) = \frac{3}{2} \times (2 \times 1) = 3. \\ 4) \phi_4^G &= \phi_5^G = \phi_6^G = \frac{3}{2} \sum_0 \phi(0) = \frac{3}{2} \times (0) = 0. \\ \Rightarrow \langle \phi^G, \phi^G \rangle_G &= \frac{1}{18} (9 + 9 + 18 + 0 + 0 + 0) = 2 \end{aligned}$$

Thus,  $\phi^G$  is the sum of two simple characters. Hence  $\phi^G - \chi^{(2)}$  is simple character. We denoted by  $\chi^{(3)}$ ,

$$\chi^{(3)} = 2, 0, 2, -1, -1, -1$$

3. In order to continue our search for the characters we use cyclic group of order 9 call it  $U$ .

$U : 1, u, u^2, u^3, u^4, u^5, u^6, u^7, u^8$ , where  $u = (1, 2, 3, 4, 5, 6, 7, 8, 9)$ .

$\lambda(u) = Z$ , where  $Z$  is an arbitrary ninth root of unity other then unity. Take  $Z = e^{\frac{2\pi i}{9}}$ , where  $Z$  can replaced by  $Z^2$ , or  $Z^3$ , or ..., or  $Z^8$  and  $Z + Z^2 + \dots + Z^8 = -1$ .

To compute the induced character  $\lambda^G$ ,  $n = [G : U] = \frac{18}{9} = 2$ .

$$(a) C_1 \cap U = 1 \Rightarrow \lambda_1^G = \frac{2}{1} \sum_1 \lambda(1) \\ = \frac{2}{1} \times 1 = 2.$$

$$(b) C_2 \cap U = 0 \Rightarrow \lambda_2^G = \frac{2}{9} \sum_0 \lambda(0) \\ = \frac{2}{9} \times 0 = 0.$$

$$(c) C_3 \cap U = \{u^5, u^4\} \Rightarrow \lambda_3^G = \frac{2}{2} \sum_{u^5+u^4} \lambda(u^5 + u^4) \\ = \frac{2}{2} \times Z^5 + Z^4 = Z^5 + Z^4.$$

$$(d) C_4 \cap U = \{u, u^8\} \Rightarrow \lambda_4^G = \frac{2}{2} \sum_{u+u^8} \lambda(u + u^8) \\ = \frac{2}{2} \times Z + Z^8 = Z + Z^8.$$

$$(e) C_5 \cap U = \{u^2, u^7\} \Rightarrow \lambda_5^G = \frac{2}{2} \sum_{u^2+u^7} \lambda(u^2 + u^7) \\ = \frac{2}{2} \times Z^2 + Z^7 = Z^2 + Z^7.$$

$$(f) C_6 \cap U = \{u^3, u^6\} \Rightarrow \lambda_6^G = \frac{2}{2} \sum_{u^3+u^6} \lambda(u^3 + u^6) \\ = \frac{2}{2} \times Z^3 + Z^6 = Z^3 + Z^6.$$

$$\chi^{(4)} = 2, 0, Z^5 + Z^4, Z + Z^8, Z^2 + Z^7, Z^3 + Z^6 \\ \chi^{(5)} = 2, 0, Z^5 + Z^4, Z^2 + Z^7, Z^3 + Z^6, Z + Z^8 \\ \chi^{(6)} = 2, 0, Z^5 + Z^4, Z^3 + Z^6, Z + Z^8, Z^2 + Z^7$$



## 9.4 Induced Character and Monomial Character

**Definition 9.28.** Let  $H \subseteq G$  and let  $\varphi$  be a class function of  $H$ . Then  $\varphi_\alpha^G$ , the **induced character** function on  $G$ , is given by

$\varphi_\alpha^G = \frac{g/h}{h_\alpha} \sum_w \varphi(w)$ , ( $w \in C_\alpha \cap H$ ) Where  $g$  and  $h$  are the order of  $G$  and  $H$  respectively, and  $C_\alpha$  the conjugacy class of  $G$ .

**Definition 9.29.** Let  $\chi$  be the character of  $G$ . Then  $\chi$  is **monomial** if  $\chi = \varphi^G$ , where  $\varphi$  is a linear character of some (not necessary proper) subgroup of  $G$ . The group  $G$  is an  $M$ -group if every  $\chi \in \text{Irr}(G)$  is monomial.

After we get the faithful linear character of the subgroup  $H$  we will work to find the **monomial matrix**. In order to find that we have to get a right transversal of  $H$  in  $G$  to determine how many  $t_i$ 's (right cosets) we have. We write  $G = Ht_1 \cup Ht_2 \cup \dots \cup Ht_n$ , so we are ready to right the monomial matrices. That is

$$A(x) = \begin{pmatrix} \varphi(t_1xt_1^{-1}) & \varphi(t_1xt_2^{-1}) & \dots & \varphi(t_1xt_n^{-1}) \\ \varphi(t_2xt_1^{-1}) & \varphi(t_2xt_2^{-1}) & \dots & \varphi(t_2xt_n^{-1}) \\ \vdots & \vdots & \dots & \vdots \\ \varphi(t_nxt_1^{-1}) & \varphi(t_nxt_2^{-1}) & \dots & \varphi(t_nxt_n^{-1}) \end{pmatrix}$$

Then, we will do the monomial matrices for other generators of  $G$ . Note, the monomial matrix has to be  $n \times n$  matrix, where  $n$  is the index of  $H$  in  $G$ . Therefore, we give some examples of groups for which we find the monomial representations matrices by using MAGMA.

## 9.5 The Monomial Progenitor $5^{*4} :_m (2^3 : 2^2)$

First, we will find all irreducible characters of the finite group  $(2^3 : 2^2)$  to search for the subgroup  $H$  of  $N$  such that  $[N : H]$  equal to a degree of an irreducible character of  $N$ .

```
> S:=Sym(8);
> aa:=S! (2, 5)(6, 7);
> bb:=S! (1, 2)(3, 7)(4, 5)(6, 8);
> cc:=S! (1, 3)(2, 6)(4, 8)(5, 7);
> dd:=S! (1, 2)(3, 6)(4, 5)(7, 8);
> ee:=S! (1, 4)(2, 5)(3, 8)(6, 7);
```

```

> N:=sub<S/aa,bb,cc,dd,ee>;
> CH:=CharacterTable(N);
> CH;
Character Table of Group N
-----
Class |  1  2  3  4  5  6  7  8  9 10 11 12 13 14 15 16 17
Size  |  1  1  2  2  2  2  2  2  2  2  2  2  2  2  2  2  2
Order |  1  2  2  2  2  2  2  2  2  2  2  4  4  4  4  4
-----
p    =  2  1  1  1  1  1  1  1  1  1  1  1  2  2  2  2  2
-----
X.1  +  1  1  1  1  1  1  1  1  1  1  1  1  1  1  1  1  1
X.2  +  1  1  1 -1 -1  1  1  1  1 -1 -1 -1 -1 -1 -1  1  1
:
:
X.16 +  1  1  1 -1  1 -1 -1 -1 -1  1 -1  1 -1  1 -1  1  1
X.17 +  4 -4  0  0  0  0  0  0  0  0  0  0  0  0  0  0  0

```

As we see there is only one irreducible character of degree 4, so we need  $H \ni [N : H] = 4$ . In the character table of  $H$  we will look for an induced linear irreducible character of  $H$  that can give an irreducible character of  $N$  of degree 8. Then we need to check if that linear character is faithful or not.

```

> S:=Subgroups(N);
> for i in [1..#S] do if #S[i]'subgroup eq 8 then i; end if; end for;
33
:
67
> H:=S[33]'subgroup;
> #H;
8
>
> ch:=CharacterTable(H);
> ch;
>
>
Character Table of Group H
-----
Class |  1  2  3  4  5  6  7  8
Size  |  1  1  1  1  1  1  1  1
Order |  1  2  2  2  4  4  4  4
-----
p    =  2  1  1  1  1  2  2  2  2
-----

```

```

X.1  +  1  1  1  1  1  1  1  1
X.2  +  1  1 -1 -1  1  1 -1 -1
X.3  0  1 -1 -1  1 -I  I  I -I
X.4  0  1 -1  1 -1 -I  I -I  I
X.5  +  1  1  1  1 -1 -1 -1 -1
X.6  +  1  1 -1 -1 -1 -1  1  1
X.7  0  1 -1 -1  1  I -I -I  I
X.8  0  1 -1  1 -1  I -I  I -I

```

*Explanation of Character Value Symbols*

---

$I = \text{RootOfUnity}(4)$

```

> I:=Induction(ch[3],N);
> I;
( 4, -4, 0, 0, 0, 0, 0, 0, 0, 0, 0, 0, 0, 0, 0, 0 )
> IsFaithful(I);
true
> Norm(I);
1
> CH[17] eq I;
true
> T:=Transversal(N,H);
> T;
{@
  Id(N),
  (2, 5)(6, 7),
  (1, 2)(3, 7)(4, 5)(6, 8),
  (1, 3)(2, 6)(4, 8)(5, 7)
@}

```

We have induced the linear faithful irreducible character  $\chi.3$  of  $H$  to the irreducible character  $\chi.17$  of  $N$ . Note the degree of  $\chi.17$  is equal to index of  $H$  in  $N$ .

```

A:= [0: i in [1..16]];
for i in [1..4] do if aa*T[i]^-1 in H then i,
ch[3](aa*T[i]^-1); end if; end for;
for i in [1..4] do if T[2]*aa*T[i]^-1 in H then i,
ch[3](T[2]*aa*T[i]^-1); end if; end for;
for i in [1..4] do if T[3]*aa*T[i]^-1 in H then i,
ch[3](T[3]*aa*T[i]^-1); end if; end for;
for i in [1..4] do if T[4]*aa*T[i]^-1 in H then i,
ch[3](T[4]*aa*T[i]^-1); end if; end for;

> A:= [0: i in [1..16]];
> A[2]:=1; A[5]:=1; A[12]:=1; A[15]:=1;

```

```

> G:=GL(4,5);
> Order(G!A);
2
> aa;
(2, 5)(6, 7)

```

```

B:=[0: i in [1..16]];
for i in [1..4] do if bb*T[i]^-1 in H then i,
ch[3](bb*T[i]^-1); end if; end for;
for i in [1..4] do if T[2]*bb*T[i]^-1 in H then i,
ch[3](T[2]*bb*T[i]^-1); end if; end for;
for i in [1..4] do if T[3]*bb*T[i]^-1 in H then i,
ch[3](T[3]*bb*T[i]^-1); end if; end for;
for i in [1..4] do if T[4]*bb*T[i]^-1 in H then i,
ch[3](T[4]*bb*T[i]^-1); end if; end for;

```

```

> B:=[0: i in [1..16]];
> B[3]:=1; B[8]:=-1; B[9]:=1; B[14]:=-1;
> G:=GL(4,5);
> Order(G!B);
2
> bb;
(1, 2)(3, 7)(4, 5)(6, 8)

```

```

C:=[0: i in [1..16]];
for i in [1..4] do if cc*T[i]^-1 in H then i,
ch[3](cc*T[i]^-1); end if; end for;
for i in [1..4] do if T[2]*cc*T[i]^-1 in H then i,
ch[3](T[2]*cc*T[i]^-1); end if; end for;
for i in [1..4] do if T[3]*cc*T[i]^-1 in H then i,
ch[3](T[3]*cc*T[i]^-1); end if; end for;
for i in [1..4] do if T[4]*cc*T[i]^-1 in H then i,
ch[3](T[4]*cc*T[i]^-1); end if; end for;

```

```

> C:=[0: i in [1..16]];
> C[4]:=1; C[7]:=1; C[10]:=1; C[13]:=1;
> G:=GL(4,5);
> Order(G!C);
2
> cc;
(1, 3)(2, 6)(4, 8)(5, 7)

```

```

D:=[0: i in [1..16]];
for i in [1..4] do if dd*T[i]^-1 in H then i,

```

```

ch[3](dd*T[i]^-1); end if; end for;
for i in [1..4] do if T[2]*dd*T[i]^-1 in H then i,
ch[3](T[2]*dd*T[i]^-1); end if; end for;
for i in [1..4] do if T[3]*dd*T[i]^-1 in H then i,
ch[3](T[3]*dd*T[i]^-1); end if; end for;
for i in [1..4] do if T[4]*dd*T[i]^-1 in H then i,
ch[3](T[4]*dd*T[i]^-1); end if; end for;

```

```

> D:= [0: i in [1..16]];
> D[2]:=2; D[5]:=3; D[12]:=3; D[15]:=2;
> G:=GL(4,5);
> Order(G!D);
2
> dd;
(1, 2)(3, 6)(4, 5)(7, 8)

```

```

E:= [0: i in [1..16]];
for i in [1..4] do if ee*T[i]^-1 in H then i,
ch[3](ee*T[i]^-1); end if; end for;
for i in [1..4] do if T[2]*ee*T[i]^-1 in H then i,
ch[3](T[2]*ee*T[i]^-1); end if; end for;
for i in [1..4] do if T[3]*ee*T[i]^-1 in H then i,
ch[3](T[3]*ee*T[i]^-1); end if; end for;
for i in [1..4] do if T[4]*ee*T[i]^-1 in H then i,
ch[3](T[4]*ee*T[i]^-1); end if; end for;

```

```

> E:= [0: i in [1..16]];
> E[1]:=-1; E[6]:=-1; E[11]:=-1; E[16]:=-1;
> G:=GL(4,5);
> Order(G!E);
2
> ee;
(1, 4)(2, 5)(3, 8)(6, 7)
> M:=sub<G|A,B,C,D,E>;
> #M;
32
> M!A, M!B, M!C, M!D, M!E;
[0 1 0 0]   [0 0 1 0]   [0 0 0 1]   [0 2 0 0]   [4 0 0 0]
[1 0 0 0]   [0 0 0 4]   [0 0 1 0]   [3 0 0 0]   [0 4 0 0]
[0 0 0 1]   [1 0 0 0]   [0 1 0 0]   [0 0 0 3]   [0 0 4 0]
[0 0 1 0]   [0 4 0 0]   [1 0 0 0]   [0 0 2 0]   [0 0 0 4]

```

Those matrices have 4 columns, we will label them by 1, 2, 3, and 4 as  $t_1, t_2, t_3$ , and  $t_4$  respectively. Hence,  $t_i$ 's are of order 4. We label  $(t_1^2, t_2^2, t_3^2, t_4^2, \dots, t_1^4, t_2^4, t_3^4, t_4^4)$  by 5

to 16. In order to replace that monomial matrices to monomial permutations we will use that labeling. We know that  $A, B, C, D$  and  $E$  are monomial automorphism of  $\langle t_1 \rangle * \langle t_2 \rangle * \langle t_3 \rangle * \langle t_4 \rangle$  given by  $a_{ij} = a \Leftrightarrow t_i \rightarrow t_j^a$ . So, we will find  $A$  and  $B, C, D$ , and  $E$  can be found similarly.

In the monomial matrix  $A$ , we have  $a_{1,2} = 1$  and  $a_{2,1} = 1$

$\Rightarrow t_1 = t_2^1 \Rightarrow t_1^2 = t_2^2, t_1^3 = t_2^3, t_1^4 = t_2^4$  gives  $(1, 2)(5, 6)(9, 10)(13, 14)$

$a_{3,4} = 1$  and  $a_{4,3} = 1$

$\Rightarrow t_3 = t_4^1 \Rightarrow t_3^2 = t_4^2, t_3^3 = t_4^3, t_3^4 = t_4^4$  gives  $(3, 4)(7, 8)(11, 12)(15, 16)$

So,  $A = (1, 2)(3, 4)(5, 6)(7, 8)(9, 10)(11, 12)(13, 14)(15, 16)$ ,

$B = (1, 3)(2, 16)(5, 7)(6, 12)(9, 11)(10, 8)(13, 15)(14, 4)$ ,

$C = (1, 4)(2, 3)(5, 8)(6, 7)(9, 12)(10, 11)(13, 16)(14, 15)$ ,

$D = (1, 6)(5, 14)(9, 2)(13, 10)(3, 12)(7, 4)(11, 16)(15, 8)$ , and

$E = (1, 13)(5, 9)(2, 14)(6, 10)(3, 15)(7, 11)(4, 16)(8, 12)$ ;

The presentation of  $N$  is  $\langle a, b, c, d, e \mid a^2 = b^2 = c^2 = d^2 = e^2 = 1, b^a = b * e, c^a = c, c^b = c * e, d^a = d * e, d^b = d, d^c = d, e^a = e, e^b = e, e^c = e, e^d = e \rangle$ . Now, we are in position to give a monomial presentation of the monomial progenitor  $5^{*4} :_m (2^3 : 2^2)$ .

We will fix one of the four  $t_i$ 's, say  $t_1$  and call it  $t$ . Then, compute the normalizer of the subgroup  $\langle t_1 \rangle$  in  $N$ . Therefore, we will compute the set stabilizer in  $N$  of the set  $\{t_1, t_1^2, t_1^3, t_1^4\} = 1, 5, 9, 13$ .

```

> S:=Sym(16);
> aa:=S! (1, 2)(3, 4)(5, 6)(7, 8)(9, 10)(11, 12)(13, 14)(15, 16);
> bb:=S! (1, 3)(2, 16)(5, 7)(6, 12)(9, 11)(10, 8)(13, 15)(14, 4);
> cc:=S! (1, 4)(2, 3)(5, 8)(6, 7)(9, 12)(10, 11)(13, 16)(14, 15);
> dd:=S! (1, 6)(5, 14)(9, 2)(13, 10)(3, 12)(7, 4)(11, 16)(15, 8);
> ee:=S! (1, 13)(5, 9)(2, 14)(6, 10)(3, 15)(7, 11)(4, 16)(8, 12);
> N:=sub<S/aa, bb, cc, dd, ee>;
> G<a, b, c, d, e>:=Group<a, b, c, d, e/a^2=b^2=c^2=d^2=e^2=1,
b^a=b*e, c^a=c, c^b=c*e, d^a=d*e, d^b=d, d^c=d,
e^a=e, e^b=e, e^c=e, e^d=e>;
> f, G1, k:=CosetAction(G, sub<G/Id(G)>);
> s:=IsIsomorphic(G1, N);
> s;
true
> s:=IsIsomorphic(M, N);
> s;
true

```

```

Sch:=SchreierSystem(G,sub<G/Id(G)>);
ArrayP:=[Id(N): i in [1..12]];
for i in [2..32] do
P:=[Id(N): l in [1..#Sch[i]]];
for j in [1..#Sch[i]] do
if Eltseq(Sch[i])[j] eq 1 then P[j]:=aa; end if;
if Eltseq(Sch[i])[j] eq 2 then P[j]:=bb; end if;
if Eltseq(Sch[i])[j] eq 3 then P[j]:=cc; end if;
if Eltseq(Sch[i])[j] eq 4 then P[j]:=dd; end if;
if Eltseq(Sch[i])[j] eq 5 then P[j]:=ee; end if;
end for;
PP:=Id(N);
for k in [1..#P] do
PP:=PP*P[k]; end for;
ArrayP[i]:=PP;
end for;
for i in [1..32] do Sch[i], ArrayP[i]; end for;

```

Now, we find the set stabilizer in  $N$  of the set  $\{t_1, t_1^2, t_1^3, t_1^4\} = \{1, 5, 9, 13\}$  is generated by two elements of order 2, let  $a * c * b = (2, 14)(4, 16)(6, 10)(8, 12)$  and  $c * b * d = (1, 5, 13, 9)(2, 10, 14, 6)(3, 11, 15, 7)(4, 8, 16, 12)$ . Hence, presentation of the monomial progenitor  $5^{*4} :_m (2^3 : 2^2)$  is given by  $G < a, b, c, d, e, t > := \text{Group} < a, b, c, d, e, t \mid a^2 = b^2 = c^2 = d^2 = e^2 = 1, b^a = b \setminus *e, c^a = c, c^b = c * e, d^a = d * e, d^b = d, d^c = d, e^a = e, e^b = e, e^c = e, e^d = e, t^5, t^{(a*c*b)} = t, t^{(c*b*d)} = t^2 >$ . After that we add more relations to the presentation of the monomial progenitor  $5^{*4} : N$  to find its homomorphic images.

```

for h,i in [0..10] do
G<a,b,c,d,e,t>:=Group<a,b,c,d,e,t|a^2=b^2=c^2=d^2=e^2=1,b^a=b \
*e,c^a=c,c^b=c*e,d^a=d*e,d^b=d,d^c=d,e^a=e,e^b=e,e^c=e,e^d=e, \
t^5,t^(a*c*b)=t,t^(c*b*d)=t^2,(e*t*t^(c*e))^h,((b*e)*t*t^d)^i>;
if #G gt 32 then h,i, Index(G,sub<G/a,b,c,d,e>), #G; end if; end for;
2 3 900 28800
> G<a,b,c,d,e,t>:=Group<a,b,c,d,e,t|a^2=b^2=c^2=d^2=e^2=1 \
,b^a=b*e,c^a=c,c^b=c*e,d^a=d*e,d^b=d,d^c=d,e^a=e,e^b=e,e^ \
c=e,e^d=e,t^5,t^(a*c*b)=t,t^(c*b*d)=t^2,(e*t*t^(c*e))^2, \
((b*e)*t*t^d)^3>;
> #G;
28800
> f,G1,k:=CosetAction(G,sub<G/a,b,c,d,e>);
> #G1;
28800

```

```

> #k;
1
> IN:=sub<G1|f(a),f(b),f(c),f(d),f(e)>;
> T:=sub<G1|f(t)>;
> # Normalizer(IN,T);
8

```

## 9.6 The Monomial Progenitor $7^*8 :_m (3^2 : 2^4)$

The group  $(3^2 : 2^4)$  of order 144 has the distinct irreducible characters  $\chi^{(1)}, \chi^{(2)}, \dots, \chi^{(9)}$ . We find there are two different irreducible characters; one of degree 2 and the other of degree 4, but the irreducible representation of degree 2 will give us an unfaithful linear character. So, we look for a subgroup of index 8 in  $N$  and take the subgroup  $H$  of order 18. By working in the character table of  $H$  and induce up to  $N$ , the third linear irreducible character of  $H$  is  $\chi^3$  to obtain the irreducible character  $\chi^{(9)}$  of  $N$ . There are 8 transversals of  $H$  in  $N$ , so there are 8  $t_i$ 's such that  $N = He \cup H(2, 3, 4, 8, 5, 7, 9, 6) \cup H(2, 4, 5, 9)(3, 8, 7, 6) \cup H(2, 5)(3, 7)(4, 9)(6, 8) \cup H(2, 7, 5, 3)(4, 8, 9, 6) \cup H(2, 7, 4, 6, 5, 3, 9, 8) \cup H(2, 9, 5, 4)(3, 6, 7, 8) \cup H(2, 6, 9, 7, 5, 8, 4, 3)$  and the monomial matrices will be  $8 \times 8$ . By using MAGMA, we get

$$A = \begin{pmatrix} 0 & 1 & 0 & 0 & 0 & 0 & 0 & 0 \\ 0 & 0 & 1 & 0 & 0 & 0 & 0 & 0 \\ 0 & 0 & 0 & 0 & 1 & 0 & 0 & 0 \\ 0 & 0 & 0 & 0 & 0 & 1 & 0 & 0 \\ 0 & 0 & 0 & 1 & 0 & 0 & 0 & 0 \\ 0 & 0 & 0 & 0 & 0 & 0 & 1 & 0 \\ 0 & 0 & 0 & 0 & 0 & 0 & 0 & 1 \\ 1 & 0 & 0 & 0 & 0 & 0 & 0 & 0 \end{pmatrix} \quad B = \begin{pmatrix} 1 & 0 & 0 & 0 & 0 & 0 & 0 & 0 \\ 0 & 0 & 0 & 0 & 1 & 0 & 0 & 0 \\ 0 & 0 & 0 & 0 & 0 & 0 & 1 & 0 \\ 0 & 0 & 0 & 1 & 0 & 0 & 0 & 0 \\ 0 & 1 & 0 & 0 & 0 & 0 & 0 & 0 \\ 0 & 0 & 0 & 0 & 0 & 0 & 0 & 1 \\ 0 & 0 & 1 & 0 & 0 & 0 & 0 & 0 \\ 0 & 0 & 0 & 0 & 0 & 1 & 0 & 0 \end{pmatrix}$$



$$\begin{array}{cc}
C = \begin{pmatrix} 0 & 0 & 1 & 0 & 0 & 0 & 0 & 0 \\ 0 & 0 & 0 & 0 & 1 & 0 & 0 & 0 \\ 0 & 0 & 0 & 1 & 0 & 0 & 0 & 0 \\ 0 & 0 & 0 & 0 & 0 & 0 & 1 & 0 \\ 0 & 0 & 0 & 0 & 0 & 1 & 0 & 0 \\ 0 & 0 & 0 & 0 & 0 & 0 & 0 & 1 \\ 1 & 0 & 0 & 0 & 0 & 0 & 0 & 0 \\ 0 & 1 & 0 & 0 & 0 & 0 & 0 & 0 \end{pmatrix} & D = \begin{pmatrix} 0 & 0 & 0 & 1 & 0 & 0 & 0 & 0 \\ 0 & 0 & 0 & 0 & 0 & 1 & 0 & 0 \\ 0 & 0 & 0 & 0 & 0 & 0 & 1 & 0 \\ 1 & 0 & 0 & 0 & 0 & 0 & 0 & 0 \\ 0 & 0 & 0 & 0 & 0 & 0 & 0 & 1 \\ 0 & 1 & 0 & 0 & 0 & 0 & 0 & 0 \\ 0 & 0 & 1 & 0 & 0 & 0 & 0 & 0 \\ 1 & 0 & 0 & 0 & 1 & 0 & 0 & 0 \end{pmatrix} \\
E = \begin{pmatrix} 4 & 0 & 0 & 0 & 0 & 0 & 0 & 0 \\ 0 & 4 & 0 & 0 & 0 & 0 & 0 & 0 \\ 0 & 0 & 2 & 0 & 0 & 0 & 0 & 0 \\ 0 & 0 & 0 & 2 & 0 & 0 & 0 & 0 \\ 0 & 0 & 0 & 0 & 1 & 0 & 0 & 0 \\ 0 & 0 & 0 & 0 & 0 & 2 & 0 & 0 \\ 0 & 0 & 0 & 0 & 0 & 0 & 4 & 0 \\ 0 & 0 & 0 & 0 & 0 & 0 & 0 & 1 \end{pmatrix} & F = \begin{pmatrix} 1 & 0 & 0 & 0 & 0 & 0 & 0 & 0 \\ 0 & 4 & 0 & 0 & 0 & 0 & 0 & 0 \\ 0 & 0 & 4 & 0 & 0 & 0 & 0 & 0 \\ 0 & 0 & 0 & 1 & 0 & 0 & 0 & 0 \\ 0 & 0 & 0 & 0 & 2 & 0 & 0 & 0 \\ 0 & 0 & 0 & 0 & 0 & 2 & 0 & 0 \\ 0 & 0 & 0 & 0 & 0 & 0 & 2 & 0 \\ 0 & 0 & 0 & 0 & 0 & 0 & 0 & 4 \end{pmatrix}
\end{array}$$

These matrices have 8 columns, we will label them by 1 to 8 as  $t_1, t_2, t_3, \dots, t_8$  respectively. The entries of the matrices are in  $Z_7$ . Hence,  $t'_i$ 's are of order 6. We label  $(t_1^2, t_2^2, t_3^2, t_4^2, t_5^2, t_6^2, t_7^2, t_8^2, \dots, t_1^6,$

$t_2^6, t_3^6, t_4^6, t_5^6, t_6^6, t_7^6, t_8^6)$  by 7 to 48. In order to replace that monomial matrices to monomial permutations we will use that labeling. We know that  $A, B, C, D, E$  and  $F$  are monomial automorphism of  $\langle t_1 \rangle * \langle t_2 \rangle * \langle t_3 \rangle * \langle t_4 \rangle * \langle t_5 \rangle * \langle t_6 \rangle * \langle t_7 \rangle * \langle t_8 \rangle$  given by  $a_{ij} = a \Leftrightarrow t_i \rightarrow t_j^a$ . So, we get that,  $A=(1, 2, 3, 5, 4, 6, 7, 8)(9, 10, 11, 13, 12, 14, 15, 16)(17, 18, 19, 21, 20, 22, 23, 24)(25, 26, 27, 29, 28, 30, 31, 32)(33, 34, 35, 37, 36, 38, 39, 40)(41, 42, 43, 45, 44, 46, 47, 48),$

$B=(2, 5)(3, 7)(6, 8)(10, 13)(11, 15)(14, 16)(18, 21)(19, 23)(22, 24)(26, 29)(27, 31)(30, 32)(34, 37)(35, 39)(38, 40)(42, 45)(43, 47)(46, 48),$

$C=(1, 3, 4, 7)(2, 5, 6, 8)(9, 11, 12, 15)(10, 13, 14, 16)(17, 19, 20, 23)(18, 21, 22, 24)(25, 27, 28, 31)(26, 29, 30, 32)(33, 35, 36, 39)(34, 37, 38, 40)(41, 43, 44, 47)(42, 45, 46, 48),$

$D=(1, 4)(2, 6)(3, 7)(5, 8)(9, 12)(10, 14)(11, 15)(13, 16)(17, 20)(18, 22)(19, 23)(21, 24)(25, 28)(26, 30)(27, 31)(29, 32)(33, 36)(34, 38)(35, 39)(37, 40)(41, 44)(42, 46)(43,$

47)(45, 48),

$E=(1, 25, 9)(2, 26, 10)(3, 11, 27)(4, 12, 28)(6, 14, 30)(7, 31, 15)(17, 33, 41)(18, 34, 42)(19, 43, 35)(20, 44, 36)(22, 46, 38)(23, 39, 47),$

and  $F=(2, 26, 10)(3, 27, 11)(5, 13, 29)(6, 14, 30)(7, 15, 31)(8, 32, 16)(18, 34, 42)(19, 35, 43)(21, 45, 37)(22, 46, 38)(23, 47, 39)(24, 40, 48);$

The presentation of  $N$  is  $\langle a, b, c, d, e, f \mid a^8, b^2, c^4, d^2, e^3, f^3, (e, f), a^2 = c, c^2 = d, b^a = b * c * d, c^a = c, c^b = c * d, d^a = d, d^b = d, d^c = d, e^a = f, e^b = e * (f^2), e^c = e * (f^2), e^d = e^2, f^a = e * (f^2), f^b = f^2, f^c = (e^2) * (f^2), f^d = f^2, f^e = f \rangle$ . Now, we are in position to give a monomial presentation of the monomial progenitor  $7^{*8} :_m N$ . We will

fix one of the forth  $t_i$ 's, say  $t_1$  and call it  $t$ . Then, compute the normalizer of the subgroup  $\langle t_1 \rangle$  in  $N$ . Therefore, we will compute the set stabilizer in  $N$  of the set

$\{t_1, t_1^2, t_1^3, t_1^4, t_1^5, t_1^6\} = 1, 9, 17, 25, 33, 41, 49, 57$ . After we find the set stabilizer in  $N$  of the set  $\{t_1, t_1^2, t_1^3, t_1^4, t_1^5, t_1^6\} = 1, 9, 17, 25, 33, 41, 49, 57$  is  $\{b, b * f^{-1}, e\}$ , where

$b = (2, 5)(3, 7)(6, 8)(10, 13)(11, 15)(14, 16)(18, 21)(19, 23)(22, 24)(26, 29)(27, 31)(30, 32)(34, 37)(35, 39)(38, 40)(42, 45)(43, 47)(46, 48),$

$b * f^{-1} = (2, 29)(3, 31)(5, 10)(6, 16)(7, 11)(8, 30)(13, 26)(14, 32)(15, 27)(18, 37)(19, 39)(21, 42)(22, 48)(23, 43)(24, 38)(34, 45)(35, 47)(40, 46),$

and  $e = (1, 25, 9)(2, 26, 10)(3, 11, 27)(4, 12, 28)(6, 14, 30)(7, 31, 15)(17, 33, 41)(18, 34, 42)(19, 43, 35)(20, 44, 36)(22, 46, 38)(23, 39, 47).$

Hence, a presentation of the monomial progenitor  $7^{*8} :_m (3^2 : 2^4)$  is given by  $G \langle a, b, c, d, e, f, t \rangle := \text{Group} \langle a, b, c, d, e, f, t \mid a^8, b^2, c^4, d^2, e^3, f^3, (e, f), a^2 = c, c^2 = d, b^a = b * c * d, c^a = c, c^b = c * d, d^a = d, d^b = d, d^c = d, e^a = f, e^b = e * (f^2), e^c = e * (f^2), e^d = e^2, f^a = e * (f^2), f^b = f^2, f^c = (e^2) * (f^2), f^d = f^2, f^e = f, t^7, t^b = t, t^{b * f^{-1}} = t, t^e = t^4 \rangle$ . To check the monomial progenitor  $7^{*8} :_m (3^2 : 2^4)$  is wright we will find the orbit of the set stabilizer in  $N$  of the set  $\{t_1, t_1^2, t_1^3, t_1^4, t_1^5, t_1^6\} = 1, 9, 17, 25, 33, 41, 49, 57$  by

MAGMA which is the following set

```
Orbits(Stabiliser(N, {1, 9, 17, 25, 33, 41}));
[ GSet{@ 1, 25, 9 @}, GSet{@ 4, 12, 28 @}, GSet{@ 17, 33, 41 @},
  GSet{@ 20, 44, 36 @}, GSet{@ 2, 5, 10, 29, 13, 26 @},
  GSet{@ 3, 7, 11, 27, 31, 15 @}, GSet{@ 6, 8, 30, 16, 32, 14 @},
  GSet{@ 18, 21, 42, 37, 45, 34 @}, GSet{@ 19, 23, 43, 35, 39, 47 @},
  GSet{@ 22, 24, 38, 48, 40, 46 @} ]
```

So, we find that  $t_1$  is commute with  $t_2, t_3$  and  $t_4$ . We will add them in to the last mono-

mial presentation then run it in MAGMA to get the order has to be  $7^8 \times 144$

$G \langle a, b, c, d, e, f, t \rangle := \text{Group} \langle a, b, c, d, e, f, t \mid a^8, b^2, c^4, d^2, e^3, f^3, (e, f), a^2 = c, c^2 = d, b^a = b * c * d, c^a = c, c^b = c * d, d^a = d, d^b = d, d^c = d, e^a = f, e^b = e * (f^2), e^c = e * (f^2), e^d = e^2, f^a = e * (f^2), f^b = f^2, f^c = (e^2) * (f^2), f^d = f^2, f^e = f, t^7, t(b) = t, t(b * f^{-1}) = t, t^e = t^4, (t, t^a), (t, t^c), (t, t^d), (t, t^{(a * d)}) \rangle;$

$G;$

830131344

### The Monomial Progenitor $3^{*5} :_m (2^4 : (2 \times 5))$

In the group  $(2^4 : (2 \times 5))$  of order 160 has the distinct irreducible characters  $\chi^{(1)}, \chi^{(2)}, \dots, \chi^{(10)}$ . We find there are two different irreducible characters; one of degree 2 and the other of degree 5, but the irreducible representation of degree 2 will give us an unfaithful linear character. So, we look at a subgroup of index 5 in  $N$  and take the subgroup  $H$  of order 32. By working in the character table of  $H$  and induce up to  $N$ , the third linear irreducible character of  $H$  is  $\chi^2$  to obtain the irreducible character  $\chi^{(6)}$  of  $N$ . There are 5 transversals of  $H$  in  $N$ , so there are 5  $t_i$ 's such that  $N = He \cup H(1, 3, 6, 10, 7)(2, 4, 8, 9, 5) \cup H(1, 6, 7, 3, 10)(2, 8, 5, 4, 9) \cup H(1, 7, 10, 6, 3)(2, 5, 9, 8, 4) \cup H(1, 10, 3, 7, 6)(2, 9, 4, 5, 8)$  and the monomial matrices will be  $5 \times 5$ . By using MAGMA, we get

$$A = \begin{pmatrix} 0 & 1 & 0 & 0 & 0 \\ 1 & 0 & 0 & 0 & 0 \\ 0 & 0 & 0 & 1 & 0 \\ 0 & 0 & 1 & 0 & 0 \\ 0 & 0 & 0 & 0 & 1 \end{pmatrix} \quad B = \begin{pmatrix} 0 & 1 & 0 & 0 & 0 \\ 0 & 0 & 1 & 0 & 0 \\ 0 & 0 & 0 & 0 & 1 \\ 1 & 0 & 0 & 0 & 0 \\ 0 & 0 & 0 & 1 & 0 \end{pmatrix} \quad C = \begin{pmatrix} 1 & 0 & 0 & 0 & 0 \\ 0 & 2 & 0 & 0 & 0 \\ 0 & 0 & 2 & 0 & 0 \\ 0 & 0 & 0 & 2 & 0 \\ 0 & 0 & 0 & 0 & 2 \end{pmatrix}$$

$$D = \begin{pmatrix} 2 & 0 & 0 & 0 & 0 \\ 0 & 2 & 0 & 0 & 0 \\ 0 & 0 & 1 & 0 & 0 \\ 0 & 0 & 0 & 1 & 0 \\ 0 & 0 & 0 & 0 & 1 \end{pmatrix} \quad E = \begin{pmatrix} 2 & 0 & 0 & 0 & 0 \\ 0 & 1 & 0 & 0 & 0 \\ 0 & 0 & 2 & 0 & 0 \\ 0 & 0 & 0 & 1 & 0 \\ 0 & 0 & 0 & 0 & 1 \end{pmatrix} \quad F = \begin{pmatrix} 2 & 0 & 0 & 0 & 0 \\ 0 & 2 & 0 & 0 & 0 \\ 0 & 0 & 2 & 0 & 0 \\ 0 & 0 & 0 & 1 & 0 \\ 0 & 0 & 0 & 0 & 2 \end{pmatrix}$$

These matrices have 5 columns, we will label them by 1 to 5 as  $t_1, t_2, t_3, t_4, t_5$  respectively. The entries of the matrices are in  $Z_3$ . Hence,  $t_i$ 's are of order 2. We label

$(t_1^2, t_2^2, t_3^2, t_4^2, t_5^2)$  by 6 to 10. In order to replace that monomial matrices to monomial permutations we will use that labeling. We know that  $A, B, C, D, E$  and  $F$  are monomial automorphism of  $\langle t_1 \rangle * \langle t_2 \rangle * \langle t_3 \rangle * \langle t_4 \rangle * \langle t_5 \rangle$  given by  $a_{ij} = a \Leftrightarrow t_i \rightarrow t_j^a$ . So, we get that,  $A=(1, 2)(3, 4)(6, 7)(8, 9)$ ,  $B=(1, 2, 3, 5, 4)(6, 7, 8, 10, 9)$ ,  $C=(2, 7)(3, 8)(4, 9)(5, 10)$ ,

$D=(1, 6)(2, 7)$ ,  $E=(1, 6)(3, 8)$ , and  $F=(1, 6)(2, 7)(3, 8)(5, 10)$ ;

The presentation of  $N$  is  $\langle a, b, c, d, e, f \mid a^2, b^5, c^2, d^2, e^2, f^2, b^a = b^4, c^a = c * d, c^b = c * d, d^a = d, d^b = d * e, d^c = d, e^a = c * d * f, e^b = e * f, e^c = e, e^d = e, f^a = c * e, f^b = c, f^c = f, f^d = f, f^e = f \rangle$ . Now, we are in position to give a monomial presentation of the monomial progenitor  $3^{*5} :_m N$ . We will fix one of the forth  $t_i$ 's, say  $t_1$  and call it  $t$ . Then, compute the normalizer of the subgroup  $\langle t_1 \rangle$  in  $N$ . Therefore, we will compute the set stabilizer in  $N$  of the set  $\{t_1, t_1^2\} = 1, 6$ . After we find the set stabilizer in  $N$  of the set  $\{t_1, t_1^2\} = 1, 6$  is

$\{(3, 8)(5, 10), (2, 7)(5, 10), (4, 9)(5, 10), (2, 4)(3, 10)(5, 8)(7, 9), (1, 6)(5, 10)\}$

and that  $d * f = (3, 8)(5, 10)$ ,  $e * f = (2, 7)(5, 10)$ ,  $c * d * e = (4, 9)(5, 10)$ ,

$a * c * b^{-1} * d = (2, 4)(3, 10)(5, 8)(7, 9)$ , and  $d * e * f = (1, 6)(5, 10)$ .

Hence, presentation of the monomial progenitor  $3^{*5} :_m (2^4 : (2 \times 5))$  is given by

$G \langle a, b, c, d, e, f, t \rangle := \text{Group} \langle a, b, c, d, e, f, t \mid a^2, b^5, c^2, d^2, e^2, f^2, b^a = b^4, c^a = c * d, c^b = c * d, d^a = d, d^b = d * e, d^c = d, e^a = c * d * f, e^b = e * f, e^c = e, e^d = e, f^a = c * e, f^b = c, f^c = f, f^d = f, f^e = f, t^3, t^{c * d * e} = t, t^{d * f} = t, t^{e * f} = t,$

$t^{a * c * (b^{-1}) * d} = t, t^{d * e * f} = t^2 \rangle$ . To check the monomial progenitor  $3^{*5} :_m (2^4 : (2 \times 5))$  is wright we will find the orbit of the set stabilizer in  $N$  of the set  $\{t_1, t_1^2\} = 1, 6$  by MAGMA which is the following set

$\text{Orbits}(\text{Stabiliser}(N, \{1, 6\}));$

$[ \text{GSet}\{\text{@ 11 @}\}, \text{GSet}\{\text{@ 12 @}\}, \text{GSet}\{\text{@ 13 @}\}, \text{GSet}\{\text{@ 14 @}\},$

$\text{GSet}\{\text{@ 15 @}\}, \text{GSet}\{\text{@ 1, 6 @}\}, \text{GSet}\{\text{@ 2, 7, 4, 9 @}\},$

$\text{GSet}\{\text{@ 3, 8, 10, 5 @}\} ]$

So, we find that  $t_1$  is commute with  $t_2$ , and  $t_3$ . We will add them in to the last monomial presentation then run it in MAGMA to get the order has to be  $3^5 \times 160$

$G \langle a, b, c, d, e, f, t \rangle := \text{Group} \langle a, b, c, d, e, f, t \mid a^2, b^5, c^2, d^2, e^2, \setminus$   
 $f^2, b^a = b^4, c^a = c * d, c^b = c * d, d^a = d, d^b = d * e, d^c = d, e^a = c * d * f, \setminus$   
 $e^b = e * f, e^c = e, e^d = e, f^a = c * e, f^b = c, f^c = f, f^d = f, f^e = f, t^3, \setminus$

```

t^(c*d*e)=t, t^(d*f)=t, t^(e*f)=t, t^(a*c*b^-1*d)\
=t, t^(d*e*f)=t^2, (t, t^a), (t, t^(a*b))>;
#G;
38880
f, G1, k:=CosetAction(G, sub<G/a, b, c, d, e, f>);
#G1; #k;
38880 1
IN:=sub<G1/f(a), f(b), f(c), f(d), f(e), f(f)>;
#IN;
160
T:=sub<G1/f(t)>;
#T;
3
# Normalizer(IN, T);
32

```

## Chapter 10

# Homomorphic Images

*In this chapter we will obtain the homomorphic images of various progenitor.*

**Theorem 10.1.** *Let  $G = \langle t_1, t_2, \dots, t_n \rangle$ , where  $|t_i| = 2$ ,  $1 \leq i \leq n$  and let  $N = \text{Normalizer}(G, \{\langle t_1 \rangle, \langle t_2 \rangle, \dots, \langle t_n \rangle\})$ , where  $N$  acts transitively on  $\{\langle t_1 \rangle, \langle t_2 \rangle, \dots, \langle t_n \rangle\}$ . Then  $G$  is a **homomorphic image** of  $2^{*n} : N$ .*

### 10.1 The Group $M_{22}$

**Example 10.2.**  $M_{22}$  is a homomorphic image of the progenitor  $2^{*16} : (2^4 : 2)$ .

*We know that,  $M_{22}$  is generated by 16 elements of order 2. Let*

$$t_1 = (1, 16)(3, 8)(5, 10)(6, 11)(7, 17)(9, 21)(13, 22)(18, 20),$$

$$t_2 = (1, 8)(2, 12)(4, 22)(5, 19)(7, 14)(9, 15)(10, 13)(16, 20),$$

$$t_3 = (1, 9)(3, 13)(5, 18)(6, 17)(7, 11)(8, 22)(10, 20)(16, 21),$$

$$t_4 = (1, 7)(2, 19)(4, 13)(5, 12)(8, 14)(9, 16)(10, 22)(15, 20),$$

$$t_5 = (1, 5)(3, 17)(6, 13)(7, 8)(9, 18)(10, 16)(11, 22)(20, 21),$$

$$t_6 = (1, 15)(2, 10)(3, 13)(6, 11)(7, 8)(12, 18)(17, 22)(19, 21),$$

$$t_7 = (1, 11)(2, 12)(3, 14)(4, 6)(5, 9)(10, 17)(15, 20)(16, 19),$$

$$t_8 = (1, 20)(3, 11)(5, 21)(6, 8)(7, 13)(9, 10)(16, 18)(17, 22),$$

$$t_9 = (1, 13)(2, 20)(4, 7)(5, 9)(8, 10)(12, 16)(14, 22)(15, 19),$$

$$t_{10} = (1, 22)(2, 9)(4, 8)(5, 20)(7, 10)(12, 15)(13, 14)(16, 19),$$

$$t_{11} = (1, 19)(2, 18)(3, 11)(6, 13)(7, 17)(8, 22)(10, 12)(15, 21),$$

$$t_{12} = (1, 3)(2, 20)(4, 17)(5, 19)(6, 10)(9, 16)(11, 14)(12, 15),$$

$$\begin{aligned}
 t_{13} &= (1, 2)(3, 17)(6, 8)(7, 11)(10, 15)(12, 21)(13, 22)(18, 19), \\
 t_{14} &= (1, 6)(2, 19)(3, 10)(4, 11)(5, 20)(9, 15)(12, 16)(14, 17), \\
 t_{15} &= (1, 17)(2, 9)(3, 4)(5, 12)(6, 14)(10, 11)(15, 19)(16, 20), \\
 t_{16} &= (1, 12)(2, 21)(3, 8)(6, 17)(7, 13)(10, 19)(11, 22)(15, 18).
 \end{aligned}$$

Then  $M_{22} = \langle t_1, t_2, t_3, t_4, t_5, t_6, t_7, t_8, t_9, t_{10}, t_{11}, t_{12}, t_{13}, t_{14}, t_{15}, t_{16} \rangle$ .

Now  $N = \text{Normalizer}(G, \{ \langle t_1 \rangle, \langle t_2 \rangle, \langle t_3 \rangle, \langle t_4 \rangle, \langle t_5 \rangle, \langle t_6 \rangle, \langle t_7 \rangle, \langle t_8 \rangle, \langle t_9 \rangle, \langle t_{10} \rangle, \langle t_{11} \rangle, \langle t_{12} \rangle, \langle t_{13} \rangle, \langle t_{14} \rangle, \langle t_{15} \rangle, \langle t_{16} \rangle \}) \cong (2^4 : 2)$  and it acts transitively on  $\{ \langle t_1 \rangle, \langle t_2 \rangle, \langle t_3 \rangle, \langle t_4 \rangle, \langle t_5 \rangle, \langle t_6 \rangle, \langle t_7 \rangle, \langle t_8 \rangle, \langle t_9 \rangle, \langle t_{10} \rangle, \langle t_{11} \rangle, \langle t_{12} \rangle, \langle t_{13} \rangle, \langle t_{14} \rangle, \langle t_{15} \rangle, \langle t_{16} \rangle \}$ . A presentation of the progenitor  $2^{*16} : (2^4 : 2)$  is given by

$$\begin{aligned}
 G \langle a, b, c, d, e, t \rangle = & \text{Group} \langle a, b, c, d, e, t \mid a^4, b^4, c^2, d^2, e^2, \\
 & ((a^{-2}) * d), ((b^{-1}) * (a^2) * (b^{-1})), ((a^{-1}) * (b^{-1}) * a * (b^{-1})), \\
 & ((a^{-1}) * c * (a^{-1}) * e), ((b^{-1}) * c * b * e), (c * e)^2, t^2, (t, c) \rangle;
 \end{aligned}$$

Table 10.1: Some Finite Homomorphic Image of  $2^{*16} : (2^4 : 2)$

$f$	...	$s$	$w$	$x$	$y$	$z$	$I$	Order of $G$	Rough Shape of $G$
0	...	0	0	0	3	0	4	6144	$2^7 : (2 \bullet S_4)$
0	...	0	0	0	3	0	5	245760	$2^{11} : \bullet(A_5 \times 2)$
0	...	0	0	3	3	3	0	768	$2^7 \bullet S_3$
0	...	0	3	0	8	0	3	1536	$2^6 : \bullet S_4$
0	...	0	3	0	4	9	9	384	$2^4 : S_4$
0	...	0	5	0	3	0	5	61440	$2^{10} : A_5$
0	...	0	6	0	3	0	4	3072	$2^7 : S_4$

## 10.2 The Group $M_{24}$

**Example 10.3.**  $M_{24}$  is a homomorphic image of the progenitor  $2^{*6} : ((2 \times 3) : 2)$ .

We know that,  $M_{24}$  is generated by 6 elements of order 2. Let

$$\begin{aligned}
 t_1 &= (2, 19)(3, 17)(4, 24)(6, 13)(10, 16)(12, 14)(15, 23)(20, 21), \\
 t_2 &= (1, 21)(2, 23)(3, 16)(8, 13)(9, 22)(10, 11)(14, 15)(17, 18), \\
 t_3 &= (1, 16)(3, 9)(5, 19)(6, 15)(7, 18)(10, 12)(11, 14)(23, 24), \\
 t_4 &= (1, 11)(3, 21)(4, 12)(5, 22)(7, 8)(9, 18)(14, 24)(17, 20), \\
 t_5 &= (1, 15)(2, 20)(4, 13)(5, 18)(6, 16)(7, 19)(8, 17)(21, 22),
 \end{aligned}$$

$$t_6 = (2, 8)(4, 7)(5, 20)(6, 12)(9, 10)(11, 22)(13, 23)(19, 24).$$

Then  $M_{24} = \langle t_1, t_2, t_3, t_4, t_5, t_6 \rangle$ .

Now  $N = \text{Normalizer}(G, \{\langle t_1 \rangle, \langle t_2 \rangle, \langle t_3 \rangle, \langle t_4 \rangle, \langle t_5 \rangle, \langle t_6 \rangle\}) \cong (2 \times 3) : 2$  and it acts transitively on  $\{\langle t_1 \rangle, \langle t_2 \rangle, \langle t_3 \rangle, \langle t_4 \rangle, \langle t_5 \rangle, \langle t_6 \rangle\}$ . A presentation of the progenitor  $(2^{*6} : ((2 \times 3) : 2))$  is given by

$$G \langle a, b, c, t \rangle := \text{Group} \langle a, b, c, t \mid a^2, b^2, c^3, (a*b)^2, (a*c^{-1})^2, (b*(c^{-1})*b*c), t^2, (t, a*b) \rangle;$$

Table 10.2: Some Finite Homomorphism Image of  $2^{*6} : ((2 \times 3) : 2)$

$f$	$g$	$h$	$i$	$j$	$k$	$l$	Order of $G$	Rough Shape of $G$
0	0	0	0	3	0	7	24360	$PGL(2, 29)$
0	0	0	0	5	5	5	1267200	$2 \bullet (2^4 \bullet L_2(11) \bullet A_5)$
0	0	4	0	8	7	10	322560	$2^3 \bullet PGL(3, 4)$
0	0	5	0	0	8	6	737280	$2^{10} \bullet S_6$
0	0	5	0	0	4	9	51840	$2 \bullet U_4(2)$
0	0	4	0	8	7	8	43008	$2^7 : PGL(2, 7)$
0	0	5	0	6	8	8	380160	$2^2 : M_{12}$

### 10.3 The Group $M_{11}$

**Example 10.4.**  $M_{11}$  is a homomorphic image of the progenitor  $2^{*8} : (2^3 : 2)$ .

We know that,  $M_{11}$  is generated by 8 elements of order 2. Let

$$t_1 = (1, 4)(2, 8)(3, 7)(9, 10),$$

$$t_1 = (1, 10)(2, 5)(3, 4)(6, 11),$$

$$t_1 = (1, 6)(2, 9)(3, 10)(7, 8),$$

$$t_1 = (1, 11)(2, 10)(3, 8)(7, 9),$$

$$t_1 = (1, 9)(2, 4)(3, 11)(5, 6),$$

$$t_1 = (1, 7)(2, 11)(3, 6)(4, 5),$$

$$t_1 = (1, 5)(2, 7)(3, 9)(8, 10),$$

$$t_1 = (1, 8)(2, 6)(3, 5)(4, 11).$$

Then  $M_{11} = \langle t_1, t_2, t_3, t_4, t_5, t_6, t_7, t_8 \rangle$ .

Now  $N = \text{Normalizer}(G, \{\langle t_1 \rangle, \langle t_2 \rangle, \langle t_3 \rangle, \langle t_4 \rangle, \langle t_5 \rangle, \langle t_6 \rangle, \langle t_7 \rangle, \langle t_8 \rangle\}) \cong (2^3 : 2)$  and it acts transitively on  $\{\langle t_1 \rangle, \langle t_2 \rangle, \langle t_3 \rangle, \langle t_4 \rangle, \langle t_5 \rangle, \langle t_6 \rangle, \langle t_7 \rangle, \langle t_8 \rangle\}$ . A presentation of the progenitor  $(2^{*8} : (2^3 : 2))$  is given by



$$G\langle a, b, c, d, t \rangle := \text{Group}\langle a, b, c, d, t \mid a^4, b^2, c^4, d^2, ((a^{-2}) * d), \\ ((c^{-1}) * (a^2) * (c^{-1})), ((a^{-1}) * (c^{-1}) * a * (c^{-1})), ((a^{-1}) * b * (a^{-1}) * b * c), \\ (b * (c^{-1}))^2, t^2, (t, b) \rangle;$$
Table 10.3: Some Finite Homomorphism Image of  $2^{*8} : (2^3 : 2)$ 

$f$	...	$i$	$j$	$k$	$l$	$m$	$n$	Order of $G$	Rough Shape of $G$
0	...	0	3	0	0	0	6	15360	$2^3 \bullet (2^4 \bullet S_5)$
0	...	0	3	0	0	0	7	21504	$2^6 \times PGL(2, 7)$
0	...	0	4	0	6	0	9	82944	82944
0	...	0	4	0	8	0	6	1290240	$2^4 \bullet (PGL(3, 4) \times 2)$
0	...	0	6	0	7	0	5	161280	$(2^2 \bullet PSL(3, 4))$

## 10.4 The Group $M_{12}$

**Example 10.5.**  $M_{12}$  is a homomorphic image of the progenitor  $2^{*8} : (2^3 : 2)$ .

We know that,  $M_{12}$  is generated by 8 elements of order 2. Let

$$t_1 = (1, 6)(2, 4)(3, 10)(5, 8)(7, 12)(9, 11),$$

$$t_2 = (1, 11)(2, 6)(3, 4)(5, 12)(7, 8)(9, 10),$$

$$t_3 = (1, 4)(2, 11)(3, 5)(6, 12)(7, 9)(8, 10),$$

$$t_4 = (1, 5)(2, 3)(4, 12)(6, 7)(8, 9)(10, 11),$$

$$t_5 = (1, 10)(2, 5)(3, 7)(4, 8)(6, 9)(11, 12),$$

$$t_6 = (1, 3)(2, 10)(4, 9)(5, 6)(7, 11)(8, 12),$$

$$t_7 = (1, 7)(2, 8)(3, 9)(4, 6)(5, 11)(10, 12),$$

$$t_8 = (1, 8)(2, 7)(3, 12)(4, 11)(5, 9)(6, 10).$$

Then  $M_{12} = \langle t_1, t_2, t_3, t_4, t_5, t_6, t_7, t_8 \rangle$ .

The  $N = \text{Normalizer}(G, \{ \langle t_1 \rangle, \langle t_2 \rangle, \langle t_3 \rangle, \langle t_4 \rangle, \langle t_5 \rangle, \langle t_6 \rangle, \langle t_7 \rangle, \langle t_8 \rangle \}) \cong (2^3 : 2)$  and it acts transitively on  $\{ \langle t_1 \rangle, \langle t_2 \rangle, \langle t_3 \rangle, \langle t_4 \rangle, \langle t_5 \rangle, \langle t_6 \rangle, \langle t_7 \rangle, \langle t_8 \rangle \}$ . A presentation of the progenitor  $2^{*8} : (2^3 : 2)$  is

$$G\langle a, b, c, d, t \rangle := \text{Group}\langle a, b, c, d, t \mid a^4, b^4, c^2, d^2, \\ ((a^{-2}) * c), ((b^{-1}) * (a^2) * (b^{-1})), ((a^{-1}) * (b^{-1}) * a * (b^{-1})), \\ (d * (b^{-1}) * (a^{-1}) * d * (b^{-1})), ((a^{-1}) * d)^2, t^2, (t, d * a) \rangle;$$

Table 10.4: Some Finite Homomorphism Image of  $2^{*8} : (2^3 : 2)$ 

$f$	...	$i$	$j$	$k$	$l$	$m$	$n$	Order of $G$	Rough Shape of $G$
0	...	0	3	0	0	0	7	21504	$2^6 : \bullet(PGL(2, 7))$
0	...	0	4	0	8	0	6	1290240	$2^4 \bullet (PGL(3, 4) \times 2)$
0	...	0	6	0	7	0	5	161280	$2^2 \bullet PGL(3, 4)$
0	...	0	6	10	0	0	4	115200	$2^2 \bullet ((A_5 \times A_5) \bullet 2^3)$

## 10.5 The Group $J_1$

**Example 10.6.**  $J_1$  is a homomorphic image of the progenitor  $2^{*19} : (19 : 2)$ .

We know that,  $J_1$  is generated by 19 elements of order 2. Then

$$J_1 = \langle t_1, t_2, t_3, t_4, t_5, t_6, t_7, t_8, t_9, t_{10}, t_{11}, t_{12}, t_{13}, t_{14}, t_{15}, t_{16}, t_{17}, t_{18}, t_{19} \rangle.$$

Now  $N = \text{Normalizer}(G, \{\langle t_1 \rangle, \langle t_2 \rangle, \langle t_3 \rangle, \langle t_4 \rangle, \langle t_5 \rangle, \langle t_6 \rangle, \langle t_7 \rangle, \langle t_8 \rangle, \langle t_9 \rangle, \langle t_{10} \rangle, \langle t_{11} \rangle, \langle t_{12} \rangle, \langle t_{13} \rangle, \langle t_{14} \rangle, \langle t_{15} \rangle, \langle t_{16} \rangle, \langle t_{17} \rangle, \langle t_{18} \rangle, \langle t_{19} \rangle\}) \cong (19 : 2)$

$\Rightarrow 2^{*19} : (19 : 2)$  acts transitively on  $\{\langle t_1 \rangle, \langle t_2 \rangle, \langle t_3 \rangle, \langle t_4 \rangle, \langle t_5 \rangle, \langle t_6 \rangle, \langle t_7 \rangle, \langle t_8 \rangle, \langle t_9 \rangle, \langle t_{10} \rangle, \langle t_{11} \rangle, \langle t_{12} \rangle, \langle t_{13} \rangle, \langle t_{14} \rangle, \langle t_{15} \rangle, \langle t_{16} \rangle, \langle t_{17} \rangle, \langle t_{18} \rangle, \langle t_{19} \rangle\}$ . A presentation of the progenitor  $2^{*19} : (19 : 2)$  is given by

$$G \langle a, b, t \rangle := \text{Group} \langle a, b, t \mid a^2, b^{-19}, ((b^{-1}) * a)^2, t^2, (t, a) \rangle;$$

## 10.6 The Group $J_2$

**Example 10.7.**  $J_2$  is a homomorphic image of the progenitor  $2^{*6} : ((2 \times 3) : 2)$ .

We know that,  $J_2$  generated by 6 elements of order 2. Let

$$t_1 = (2, 26)(3, 59)(5, 93)(6, 28)(7, 90)(8, 75)(9, 18)(11, 30)(14, 39)(15, 56)(16, 49)(17, 78)(19, 21)(22, 44)(23, 62)(24, 81)(25, 95)(29, 92)(31, 89)(33, 76)(34, 65)(35, 50)(36, 94)(37, 98)(40, 85)(42, 67)(43, 52)(45, 47)(46, 61)(48, 58)(51, 79)(53, 57)(54, 91)(60, 72)(63, 84)(68, 87)(70, 74)(71, 97)(73, 96)(77, 82),$$

$$t_2 = (1, 17)(2, 94)(3, 92)(4, 71)(5, 56)(6, 90)(7, 80)(8, 41)(9, 39)(10, 25)(12, 36)(13, 53)(15, 64)(18, 20)(21, 75)(23, 38)(24, 63)(27, 34)(29, 86)(30, 78)(31, 51)(32, 89)(35, 65)(37, 99)(40, 100)(42, 96)(43, 66)(44, 85)(46, 97)(47, 82)(48, 95)(49, 57)(52, 60)(55, 77)(62, 91)(68, 88)(69, 73)(70,$$

98)(76, 87)(83, 84),

$t_3 = (1, 47)(2, 12)(3, 11)(4, 64)(5, 79)(6, 65)(8, 52)(9, 46)(10, 45)(13, 32)(14, 31)(15, 16)(18, 57)(19, 63)(22, 35)(23, 34)(24, 98)(25, 68)(26, 69)(28, 76)(29, 77)(30, 87)(33, 62)(36, 67)(37, 56)(38, 58)(43, 93)(44, 92)(48, 80)(49, 81)(50, 82)(51, 75)(53, 72)(54, 55)(59, 95)(60, 61)(66, 83)(73, 96)(74, 97)(91, 100),$

$t_4 = (1, 14)(3, 92)(4, 21)(6, 41)(7, 100)(8, 12)(9, 99)(10, 73)(11, 27)(13, 94)(15, 82)(17, 93)(18, 79)(19, 22)(20, 50)(24, 86)(25, 98)(26, 61)(28, 72)(30, 70)(32, 77)(34, 58)(35, 42)(36, 87)(37, 64)(38, 85)(39, 47)(40, 57)(43, 62)(46, 80)(49, 97)(52, 88)(55, 65)(59, 83)(66, 71)(69, 78)(75, 91)(76, 90)(81, 84)(89, 96),$

$t_5 = (1, 40)(3, 42)(4, 33)(6, 39)(7, 16)(8, 81)(9, 23)(10, 92)(11, 74)(12, 37)(13, 18)(15, 82)(17, 52)(19, 80)(20, 75)(21, 48)(22, 93)(25, 83)(26, 79)(27, 56)(28, 86)(29, 54)(31, 60)(32, 70)(35, 85)(36, 65)(38, 73)(41, 59)(44, 99)(46, 88)(47, 98)(51, 100)(53, 95)(55, 78)(61, 71)(64, 89)(66, 94)(69, 90)(76, 87)(84, 96),$

$t_6 = (2, 92)(3, 14)(5, 41)(6, 65)(10, 88)(11, 96)(12, 49)(13, 93)(15, 23)(16, 69)(17, 53)(19, 91)(20, 42)(21, 78)(22, 68)(24, 82)(26, 30)(28, 44)(29, 73)(31, 77)(32, 80)(33, 89)(34, 87)(37, 98)(39, 62)(40, 79)(43, 74)(45, 90)(48, 97)(50, 95)(51, 58)(54, 57)(56, 59)(60, 66)(61, 63)(64, 67)(71, 85)(72, 99)(76, 81)(83, 100).$

Then  $J_2 = \langle t_1, t_2, t_3, t_4, t_5, t_6 \rangle$ .

Now  $N = \text{Normalizer}(G, \{\langle t_1 \rangle, \langle t_2 \rangle, \langle t_3 \rangle, \langle t_4 \rangle, \langle t_5 \rangle, \langle t_6 \rangle\}) \cong ((2 \times 3) : 2)$  and it acts transitively on  $\{\langle t_1 \rangle, \langle t_2 \rangle, \langle t_3 \rangle, \langle t_4 \rangle, \langle t_5 \rangle, \langle t_6 \rangle\}$ . A presentation of the progenitor  $2^{*6} : ((2 \times 3) : 2)$  is given by

$G\langle a, b, c, t \rangle = \text{Group}\langle a, b, c, t \mid a^2, b^2, c^3, (a*b)^2, (a*(c^{-1}))^2, (b*(c^{-1})*b*c), t^2, (t, a*b) \rangle;$

**Example 10.8.**  $J_2$  is a homomorphic image of the progenitor  $2^{*12} : ((2^2 \times 3) : 2)$ .

We know that,  $J_2$  is generated by 12 elements of order 2. Let

$t_1 = (2, 94)(3, 17)(4, 37)(5, 89)(6, 27)(7, 76)(8, 83)(10, 29)(13, 14)(15,$

Table 10.5: Some Finite Homomorphism Image of  $2^{*6} : ((2 \times 3) : 2)$ 

$f$	$g$	$h$	$i$	$j$	$k$	$l$	Order of $G$	Rough Shape of $G$
0	0	0	0	4	5	0	13680	$2 : PGL(2, 19)$
0	0	0	5	5	5	8	322560	$(2^3 \times PSL(3, 4)) : 2$
0	0	0	0	5	8	6	737280	$2^{10} : \bullet S_6$
0	0	0	0	10	3	10	483840	$(2 \times S_3) \bullet PGL(3, 4)$
0	0	0	4	6	4	7	10080	$2 : S_7$

72)(16, 43)(18, 32)(19, 66)(20, 46)(23, 82)(24, 99)(25, 62)(26, 73)(30,  
88)(31, 57)(33, 58)(34, 55)(35, 40)(36, 96)(38, 68)(41, 51)(44, 86)(45,  
59)(47, 78)(48, 90)(49, 84)(50, 54)(52, 63)(53, 93)(56, 97)(60, 71)(64,  
74)(67, 69)(77, 95)(85, 91),

$t_2 = (1, 10)(3, 87)(5, 75)(6, 23)(7, 90)(8, 93)(9, 60)(11, 95)(12, 69)(14,$   
89)(15, 81)(16, 37)(17, 78)(18, 72)(19, 84)(21, 63)(22, 82)(24, 56)(25,  
30)(28, 62)(29, 50)(31, 39)(33, 34)(35, 92)(36, 42)(38, 80)(40, 85)(43,  
79)(44, 77)(46, 57)(49, 98)(51, 52)(53, 61)(55, 100)(59, 68)(65, 76)(67,  
94)(70, 97)(71, 74)(73, 96),

$t_3 = (1, 98)(2, 55)(3, 20)(5, 66)(6, 10)(7, 13)(8, 83)(9, 80)(12, 31)(14, 54)(15,$   
77)(16, 58)(17, 43)(21, 69)(22, 65)(23, 49)(24, 53)(27, 30)(29, 38)(33,  
46)(34, 36)(35, 45)(39, 63)(41, 95)(42, 57)(44, 94)(47, 72)(48, 62)(50,  
60)(51, 78)(52, 79)(56, 70)(61, 97)(64, 85)(67, 81)(68, 88)(71, 76)(74,  
82)(84, 91)(86, 96),

$t_4 = (12, 35)(13, 48)(15, 32)(16, 80)(17, 100)(18, 21)(20, 53)(22, 93)(23,$   
69)(26, 79)(28, 29)(30, 77)(31, 40)(33, 71)(36, 99)(37, 85)(38, 39)(41,  
81)(42, 83)(44, 65)(47, 64)(51, 52)(54, 86)(68, 97)(70, 82)(75, 95)(76,  
87)(89, 98)(92, 96),

$t_5 = (1, 2)(3, 17)(4, 52)(5, 84)(6, 83)(8, 77)(10, 15)(12, 58)(13, 93)(16,$   
30)(18, 48)(19, 88)(20, 49)(21, 22)(23, 43)(24, 26)(25, 86)(27, 31)(28,  
39)(29, 64)(32, 34)(33, 42)(38, 47)(41, 46)(45, 87)(50, 65)(51, 89)(54,  
100)(55, 97)(56, 90)(57, 95)(59, 80)(60, 69)(61, 98)(66, 82)(67, 99)(71,  
73)(72, 85)(74, 91)(92, 94),

$t_6 = (1, 35)(2, 73)(3, 80)(4, 49)(5, 83)(6, 11)(7, 34)(8, 39)(9, 24)(12, 36)(13,$   
31)(14, 61)(15, 99)(17, 68)(18, 70)(19, 79)(20, 53)(21, 37)(22, 30)(26,  
42)(27, 62)(28, 44)(29, 40)(32, 60)(41, 43)(45, 78)(46, 75)(47, 87)(48,

65)(51, 98)(54, 85)(58, 90)(63, 66)(64, 97)(67, 96)(74, 81)(76, 100)(82, 86)(88, 95)(91, 92),

$t_7 = (2, 78)(3, 57)(4, 88)(5, 94)(6, 63)(7, 58)(8, 67)(9, 49)(11, 15)(14, 29)(16, 18)(17, 26)(19, 23)(21, 62)(24, 95)(25, 81)(27, 32)(28, 84)(30, 56)(31, 50)(34, 65)(35, 89)(36, 93)(37, 60)(39, 92)(40, 47)(42, 75)(43, 52)(45, 85)(46, 68)(48, 90)(53, 59)(54, 73)(55, 100)(61, 87)(66, 99)(71, 97)(72, 98)(77, 82)(91, 96),$

$t_8 = (1, 30)(2, 12)(3, 86)(4, 46)(5, 64)(6, 80)(9, 14)(10, 48)(11, 78)(13, 49)(16, 57)(19, 75)(20, 39)(21, 41)(22, 85)(24, 83)(26, 94)(27, 35)(28, 90)(31, 79)(32, 51)(33, 87)(38, 91)(42, 69)(44, 100)(45, 82)(47, 55)(50, 65)(52, 72)(54, 62)(56, 93)(58, 95)(59, 92)(60, 66)(61, 97)(63, 81)(67, 96)(70, 99)(74, 98)(76, 88),$

$t_9 = (2, 88)(4, 37)(5, 40)(6, 55)(7, 51)(9, 80)(10, 96)(11, 92)(12, 52)(13, 77)(14, 47)(15, 50)(16, 20)(17, 33)(19, 35)(21, 56)(23, 85)(24, 25)(27, 44)(29, 94)(30, 36)(31, 39)(34, 38)(41, 54)(42, 63)(45, 89)(48, 99)(53, 90)(57, 79)(59, 66)(60, 78)(61, 69)(62, 93)(67, 70)(68, 86)(71, 95)(72, 76)(74, 84)(75, 100)(81, 97),$

$t_{10} = (1, 47)(2, 28)(3, 77)(4, 67)(6, 65)(8, 52)(9, 46)(11, 29)(12, 76)(13, 74)(14, 96)(15, 87)(16, 30)(17, 99)(18, 54)(19, 83)(22, 25)(23, 69)(24, 95)(26, 34)(31, 73)(32, 97)(35, 68)(36, 64)(37, 82)(38, 51)(39, 89)(40, 41)(43, 48)(44, 81)(49, 92)(50, 56)(55, 57)(58, 75)(59, 98)(60, 100)(61, 91)(63, 66)(80, 93)(88, 90),$

$t_{11} = (1, 95)(3, 18)(4, 6)(5, 34)(7, 37)(10, 17)(11, 78)(12, 16)(13, 42)(15, 86)(19, 35)(20, 60)(21, 83)(22, 94)(24, 72)(25, 48)(26, 46)(27, 76)(28, 82)(29, 32)(31, 75)(33, 39)(38, 61)(40, 53)(41, 59)(44, 99)(45, 49)(51, 84)(52, 92)(54, 70)(55, 74)(56, 87)(62, 67)(64, 89)(66, 93)(69, 90)(71, 73)(79, 88)(80, 85)(96, 100),$

$t_{12} = (1, 10)(2, 7)(3, 63)(5, 9)(6, 53)(8, 60)(11, 30)(14, 39)(16, 94)(17, 58)(18, 93)(19, 87)(20, 64)(21, 68)(22, 97)(23, 46)(24, 81)(26, 90)(27, 32)(28, 57)(33, 52)(34, 79)(35, 50)(36, 49)(37, 42)(40, 91)(43, 76)(44, 71)(45, 96)(47, 73)(48, 78)(51, 65)(54, 85)(59, 84)(61, 62)(67, 98)(70, 77)(72, 75)(74, 82)(83, 86).$

Then  $J_2 = \langle t_1, t_2, t_3, t_4, t_5, t_6, t_7, t_8, t_9, t_{10}, t_{11}, t_{12} \rangle$ .

Now  $N = \text{Normalizer}(G, \{\langle t_1 \rangle, \langle t_2 \rangle, \langle t_3 \rangle, \langle t_4 \rangle, \langle t_5 \rangle, \langle t_6 \rangle, \langle t_7 \rangle, \langle t_8 \rangle, \langle t_9 \rangle, \langle t_{10} \rangle, \langle t_{11} \rangle, \langle t_{12} \rangle\}) \cong ((2^2 \times 3) : 2)$  and it acts transitively on  $\{\langle t_1 \rangle, \langle t_2 \rangle, \langle t_3 \rangle, \langle t_4 \rangle, \langle t_5 \rangle, \langle t_6 \rangle, \langle t_7 \rangle, \langle t_8 \rangle, \langle t_9 \rangle, \langle t_{10} \rangle, \langle t_{11} \rangle, \langle t_{12} \rangle\}$ . A presentation of the progenitor  $2^{*12} : ((2^2 \times 3) : 2)$  is given by

$G\langle a, b, c, d, t \rangle := \text{Group}\langle a, b, c, d, t \mid b^3, c^2, ((a^{-2})^*(d^{-1})), (b*(a^2)*(d^{-1})), ((a^{-1})^*c)^2, t^2, (t, a*c) \rangle;$

Table 10.6: Some Finite Homomorphism Image of  $2^{*12} : ((2^2 \times 3) : 2)$

$e$	...	$l$	$m$	$n$	$o$	$p$	$q$	Order of $G$	Rough Shape of $G$
0	...	0	0	0	3	4	6	3542880	$(2 \times PGL(2, 121)) : 2$
0	...	0	0	3	0	4	8	172032	$2^9 : \bullet PGL(2, 7)$
0	...	0	0	3	0	4	10	1488000	$2 \bullet PGL(3, 5)$
0	...	0	0	3	5	0	10	322560	322560
0	...	0	0	6	3	6	6	6298560	6298560
0	...	0	3	0	6	0	4	31457280	31457280
0	...	0	3	0	7	4	0	9596496	$(13^3 \times 2) : \bullet(PGL(2, 13))$
0	...	0	5	4	0	5	5	983040	983040

## Appendix A

# MAGMA Code for DCE of $L_2(8)$ Over $2^2$

```

S:=Sym(4);
xx:=S!(1,2)(3,4);
yy:=S!(1,3)(2,4);
N:=sub<S|xx,yy>;
G<x,y,t>:=Group<x,y,t|x^2,y^2,(x,y),t^2,(x*y*x*t)^7,
(x*t)^9,(x*y*t)^3>;
f,G1,k:=CosetAction(G,sub<G|x,y>);
#G1, #k;
CompositionFactors(G1);
#sub<G|x,y>;
#DoubleCosets(G,sub<G|x,y>,sub<G|x,y>);
IsSimple(G1);
IsTransitive(N);

DoubleCosets(G,sub<G|x,y>,sub<G|x,y>);

Sch:=SchreierSystem(G,sub<G|Id(G)>);
ArrayP:=[Id(N): i in [1..504]];
for i in [2..504] do
P:=[Id(N): l in [1..#Sch[i]]];
for j in [1..#Sch[i]] do
if Eltseq(Sch[i])[j] eq 1 then P[j]:=xx; end if;
if Eltseq(Sch[i])[j] eq 2 then P[j]:=yy; end if;
end for;
PP:=Id(N);
for k in [1..#P] do

```

```

PP:=PP*P[k]; end for;
ArrayP[i]:=PP;
end for;
ts:=[f(t),f(t^x),f(t^y),f(t^(x*y))];
IN:=sub<G1|f(x),f(y)>;
  prodim := function(pt, Q, I)
/*
Return the image of pt under permutations Q[I] applied sequentially.
*/
  v := pt;
  for i in I do
  v := v^(Q[i]);
  end for;
  return v;
end function;

per2sym := function(G1,N, p)
  ww := cst[1^p];
  tt := p * @*[G1|ts[ww[#ww - l + 1]]: l in [1 .. #ww]];
  zz := N![rep{j: j in [1..4] | (1^ts[i])^tt eq 1^ts[j]}:
i in [1..4]]; return <zz, ww>;
end function;
cst := [null : i in [1 ..126]] where null is [Integers() | ];
for i := 1 to 4 do
cst[prodim(1, ts, [i])] := [i];
end for;
m:=0;
for i in [1..126] do if cst[i] ne [] then m:=m+1; end if; end for; m;
N1:=Stabiliser(N,1);
Orbits(N1);
#N1;
-----
S:={[1,2]};
SS:=S^N;
SS;
SSS:=Setseq(SS);
for i in [1..#SS] do
for g in IN do if ts[1]*ts[2] eq g*ts[Rep(SSS[i])[1]]
*ts[Rep(SSS[i])[2]] then print SSS[i]; end if; end for;
end for;
N12:=Stabiliser(N,[1,2]);
#N12;
Orbits(N12);
#SSS;

```



```

T12:=Transversal(N,N12);
for i in [1..#T12] do
ss:=[1,2]^T12[i];
cst[prodim(1, ts, ss)] := ss;
end for;
m:=0;
for i in [1..126] do if cst[i] ne [] then m:=m+1; end if;
end for; m; for i in [1..#T12] do [1,2]^T12[i]; end for;
-----

Z:={[1,3]};
ZZ:=Z^N;
ZZ;
ZZZ:=Setseq(ZZ);
for i in [1..#ZZZ] do
for g in IN do if ts[1]*ts[3] eq g*ts[Rep(ZZZ[i])[1]]
*ts[Rep(ZZZ[i])[2]] then print ZZZ[i]; end if; end for;
end for;
N13:=Stabiliser(N, [1,3]);
N13;
Orbits(N13);
#N13;
#ZZZ;
T13:=Transversal(N,N13);
for i in [1..#T13] do
ss:=[1,3]^T13[i];
cst[prodim(1, ts, ss)] := ss;
end for;
m:=0;
for i in [1..126] do if cst[i] ne [] then m:=m+1; end if;
end for; m;
for i in [1..#T13] do [1,3]^T13[i]; end for;
-----

S:={[1,2,4]};
SS:=S^N;
SS;
SSS:=Setseq(SS);
for i in [1..#SSS] do
for g in IN do if ts[1]*ts[2]*ts[4] eq g*ts[Rep(SSS[i])[1]]
*ts[Rep(SSS[i])[2]]*ts[Rep(SSS[i])[3]] then print SSS[i];
end if; end for; end for;
N124:=Stabiliser(N, [1,2,4]);
#N124;
Orbits(N124);
#SSS;

```

```

T124:=Transversal(N,N124);
for i in [1..#T124] do
ss:=[1,2,4]^T124[i];
cst[prodim(1, ts, ss)] := ss;
end for;
m:=0;
for i in [1..126] do if cst[i] ne [] then m:=m+1; end if; end for; m;
for i in [1..#T124] do [1,2,4]^T124[i]; end for;
-----

S:={[1,2,1]};
SS:=S^N;
SS;
SSS:=Setseq(SS);
for i in [1..#SS] do
for g in IN do if ts[1]*ts[2]*ts[1] eq g*ts[Rep(SSS[i])[1]]
*ts[Rep(SSS[i])[2]]*ts[Rep(SSS[i])[3]] then print SSS[i];
end if; end for; end for;
N121:=Stabiliser(N,[1,2,1]);
#N121;
Orbits(N121);
#SSS;
T121:=Transversal(N,N121);
for i in [1..#T121] do
ss:=[1,2,1]^T121[i];
cst[prodim(1, ts, ss)] := ss;
end for;
m:=0;
for i in [1..126] do if cst[i] ne [] then m:=m+1; end if; end for; m;
for i in [1..#T121] do [1,2,1]^T121[i]; end for;
-----

Z:={[1,3,4]};
ZZ:=Z^N;
ZZ;
ZZZ:=Setseq(ZZ);
for i in [1..#ZZ] do
for g in IN do if ts[1]*ts[3]*ts[4] eq g*ts[Rep(ZZZ[i])[1]]
*ts[Rep(ZZZ[i])[2]]*ts[Rep(ZZZ[i])[3]] then print ZZZ[i];
end if; end for; end for;
N134:=Stabiliser(N,[1,3,4]);
N134;
Orbits(N134);
#ZZZ;
T134:=Transversal(N,N134);
for i in [1..#T134] do

```

```

ss:=[1,3,4]^T134[i];
cst[prodim(1, ts, ss)] := ss;
end for;
m:=0;
for i in [1..126] do if cst[i] ne [] then m:=m+1; end if; end for; m;
for i in [1..#T134] do [1,3,4]^T134[i]; end for;
-----
Z:={[1,3,1]};
ZZ:=Z^N;
ZZ;
ZZZ:=Setseq(ZZ);
for i in [1..#ZZ] do
for g in IN do if ts[1]*ts[3]*ts[1] eq g*ts[Rep(ZZZ[i])[1]]
*ts[Rep(ZZZ[i])[2]]*ts[Rep(ZZZ[i])[3]] then print ZZZ[i];
end if; end for; end for;
N131:=Stabiliser(N,[1,3,1]);
N131;
Orbits(N131);
#ZZZ;
T131:=Transversal(N,N131);
for i in [1..#T131] do
ss:=[1,3,1]^T131[i];
cst[prodim(1, ts, ss)] := ss;
end for;
m:=0;
for i in [1..126] do if cst[i] ne [] then m:=m+1; end if; end for; m;
for i in [1..#T131] do [1,3,1]^T131[i]; end for;
-----
S:={[1,2,4,2]};
SS:=S^N;
SS;
SSS:=Setseq(SS);
for i in [1..#SS] do
for g in IN do if ts[1]*ts[2]*ts[4]*ts[2] eq g*ts[Rep(SSS[i])[1]]
*ts[Rep(SSS[i])[2]]*ts[Rep(SSS[i])[3]]*ts[Rep(SSS[i])[4]]
then print SSS[i]; end if; end for; end for;
N1242:=Stabiliser(N,[1,2,4,2]);
#N1242;
for g in N do if 1^g eq 3 and 2^g eq 4 and 4^g eq 2 and
2^g eq 4 then N1242:=sub<N/N1242,g>; end if; end for;
Orbits(N1242);
[1,2,4,2]^N1242;
#N1242;
T1242:=Transversal(N,N1242);

```

```

for i in [1..#T1242] do
ss:=[1,2,4,2]^T1242[i];
cst[prodim(1, ts, ss)] := ss;
end for;
m:=0;
for i in [1..126] do if cst[i] ne [] then m:=m+1; end if; end for; m;
for i in [1..#T1242] do [1,2,4,2]^T1242[i]; end for;
-----
S:={[1,2,4,3]};
SS:=S^N;
SS;
SSS:=Setseq(SS);
for i in [1..#SS] do
for g in IN do if ts[1]*ts[2]*ts[4]*ts[3] eq g*ts[Rep(SSS[i])[1]]
*ts[Rep(SSS[i])[2]]*ts[Rep(SSS[i])[3]]*ts[Rep(SSS[i])[4]]
then print SSS[i]; end if; end for; end for;
N1243:=Stabiliser(N, [1,2,4,3]);
#N1243;
Orbits(N1243);
#SSS;
T1243:=Transversal(N,N1243);
for i in [1..#T1243] do
ss:=[1,2,4,3]^T1243[i];
cst[prodim(1, ts, ss)] := ss;
end for;
m:=0;
for i in [1..126] do if cst[i] ne [] then m:=m+1; end if; end for; m;
for i in [1..#T1243] do [1,2,4,3]^T1243[i]; end for;
-----
S:={[1,2,1,2]};
SS:=S^N;
SS;
SSS:=Setseq(SS);
for i in [1..#SS] do
for g in IN do if ts[1]*ts[2]*ts[1]*ts[2] eq g*ts[Rep(SSS[i])[1]]
*ts[Rep(SSS[i])[2]]*ts[Rep(SSS[i])[3]]*ts[Rep(SSS[i])[4]]
then print SSS[i]; end if; end for; end for;
N1212:=Stabiliser(N, [1,2,1,2]);
#N1212;
Orbits(N1212);
#SSS;
T1212:=Transversal(N,N1212);
for i in [1..#T1212] do
ss:=[1,2,1,2]^T1212[i];

```

```

cst[prodim(1, ts, ss)] := ss;
end for;
m:=0;
for i in [1..126] do if cst[i] ne [] then m:=m+1; end if; end for; m;
for i in [1..#T1212] do [1,2,1,2]^T1212[i]; end for;
-----
S:={[1,2,1,3]};
SS:=S^N;
SS;
SSS:=Setseq(SS);
for i in [1..#SS] do
for g in IN do if ts[1]*ts[2]*ts[1]*ts[3] eq g*ts[Rep(SSS[i])[1]]
*ts[Rep(SSS[i])[2]]*ts[Rep(SSS[i])[3]]*ts[Rep(SSS[i])[4]]
then print SSS[i]; end if; end for; end for;
N1213:=Stabiliser(N,[1,2,1,3]);
#N1213;
Orbits(N1213);
#SSS;
T1213:=Transversal(N,N1213);
for i in [1..#T1213] do
ss:=[1,2,1,3]^T1213[i];
cst[prodim(1, ts, ss)] := ss;
end for;
m:=0;
for i in [1..126] do if cst[i] ne [] then m:=m+1; end if; end for; m;
for i in [1..#T1213] do [1,2,1,3]^T1213[i]; end for;
-----
Z:={[1,3,4,2]};
ZZ:=Z^N;
ZZ;
ZZZ:=Setseq(ZZ);
for i in [1..#ZZ] do
for g in IN do if ts[1]*ts[3]*ts[4]*ts[2] eq g*ts[Rep(ZZZ[i])[1]]
*ts[Rep(ZZZ[i])[2]]*ts[Rep(ZZZ[i])[3]]*ts[Rep(ZZZ[i])[4]]
then print ZZZ[i]; end if; end for; end for;
N1342:=Stabiliser(N,[1,3,4,2]);
N1342;
Orbits(N1342);
#N1342;
#ZZZ;
T1342:=Transversal(N,N1342);
for i in [1..#T1342] do
ss:=[1,3,4,2]^T1342[i];
cst[prodim(1, ts, ss)] := ss;

```

```

end for;
m:=0;
for i in [1..126] do if cst[i] ne [] then m:=m+1; end if; end for; m;
for i in [1..#T1342] do [1,3,4,2]^T1342[i]; end for;
-----
Z:={[1,3,4,3]};
ZZ:=Z^N;
ZZ;
ZZZ:=Setseq(ZZ);
for i in [1..#ZZZ] do
for g in IN do if ts[1]*ts[3]*ts[4]*ts[3] eq g*ts[Rep(ZZZ[i])[1]]
*ts[Rep(ZZZ[i])[2]]*ts[Rep(ZZZ[i])[3]]*ts[Rep(ZZZ[i])[4]]
then print ZZZ[i]; end if; end for; end for;
N1343:=Stabiliser(N,[1,3,4,3]);
N1343;
Orbits(N1343);
#ZZZ;
T1343:=Transversal(N,N1343);
for i in [1..#T1343] do
ss:=[1,3,4,3]^T1343[i];
cst[prodim(1, ts, ss)] := ss;
end for;
m:=0;
for i in [1..126] do if cst[i] ne [] then m:=m+1; end if; end for; m;
for i in [1..#T1343] do [1,3,4,3]^T1343[i]; end for;
-----
Z:={[1,3,1,2]};
ZZ:=Z^N;
ZZ;
ZZZ:=Setseq(ZZ);
for i in [1..#ZZZ] do
for g in IN do if ts[1]*ts[3]*ts[1]*ts[2] eq g*ts[Rep(ZZZ[i])[1]]
*ts[Rep(ZZZ[i])[2]]*ts[Rep(ZZZ[i])[3]]*ts[Rep(ZZZ[i])[4]]
then print ZZZ[i]; end if; end for; end for;
N1312:=Stabiliser(N,[1,3,1,2]);
N1312;
for g in N do if 1^g eq 4 and 3^g eq 2 and 1^g eq 4
and 2^g eq 3 then N1312:=sub<N|N1312,g>; end if; end for;
[1,3,1,2]^N1312;
Orbits(N1312);
#N1312;
T1312:=Transversal(N,N1312);
for i in [1..#T1312] do
ss:=[1,3,1,2]^T1312[i];

```

```

cst[prodim(1, ts, ss)] := ss;
end for;
m:=0;
for i in [1..126] do if cst[i] ne [] then m:=m+1; end if; end for; m;
for i in [1..#T1312] do [1,3,1,2]^T1312[i]; end for;
-----
S:={[1,2,4,3,4]};
SS:=S^N;
SS;
SSS:=Setseq(SS);
for i in [1..#SS] do
for g in IN do if ts[1]*ts[2]*ts[4]*ts[3]*ts[4] eq g
*ts[Rep(SSS[i])[1]]*ts[Rep(SSS[i])[2]]*ts[Rep(SSS[i])[3]]
*ts[Rep(SSS[i])[4]]*ts[Rep(SSS[i])[5]]
then print SSS[i]; end if; end for; end for;
N12434:=Stabiliser(N,[1,2,4,3,4]);
#N12434;
Orbits(N12434);
#SSS;
T12434:=Transversal(N,N12434);
for i in [1..#T12434] do
ss:=[1,2,4,3,4]^T12434[i];
cst[prodim(1, ts, ss)] := ss;
end for;
m:=0;
for i in [1..126] do if cst[i] ne [] then m:=m+1; end if; end for; m;
for i in [1..#T12434] do [1,2,4,3,4]^T12434[i]; end for;
-----
S:={[1,2,4,3,1]};
SS:=S^N;
SS;
SSS:=Setseq(SS);
for i in [1..#SS] do
for g in IN do if ts[1]*ts[2]*ts[4]*ts[3]*ts[1] eq g
*ts[Rep(SSS[i])[1]]*ts[Rep(SSS[i])[2]]*ts[Rep(SSS[i])[3]]
*ts[Rep(SSS[i])[4]]*ts[Rep(SSS[i])[5]]
then print SSS[i]; end if; end for; end for;
N12431:=Stabiliser(N,[1,2,4,3,1]);
#N12431;
Orbits(N12431);
#SSS;
T12431:=Transversal(N,N12431);
for i in [1..#T12431] do
ss:=[1,2,4,3,1]^T12431[i];

```

```

cst[prodim(1, ts, ss)] := ss;
end for;
m:=0;
for i in [1..126] do if cst[i] ne [] then m:=m+1; end if; end for; m;
for i in [1..#T12431] do [1,2,4,3,1]^T12431[i]; end for;
-----
S:={[1,2,1,2,4]};
SS:=S^N;
SS;
SSS:=Setseq(SS);
for i in [1..#SS] do
for g in IN do if ts[1]*ts[2]*ts[1]*ts[2]*ts[4] eq g
*ts[Rep(SSS[i])[1]]*ts[Rep(SSS[i])[2]]*ts[Rep(SSS[i])[3]]
*ts[Rep(SSS[i])[4]]*ts[Rep(SSS[i])[5]] then print SSS[i];
end if; end for; end for;
N12124:=Stabiliser(N, [1,2,1,2,4]);
#N12124;
for g in N do if 1^g eq 4 and 2^g eq 3 and 1^g eq 4
and 2^g eq 3 and 4^g eq 1 then N12124:=sub<N/N12124,g>;
end if; end for; [1,2,1,2,4]^N12124;
Orbits(N12124);
#N12124;
T12124:=Transversal(N,N12124);
for i in [1..#T12124] do
ss:=[1,2,1,2,4]^T12124[i];
cst[prodim(1, ts, ss)] := ss;
end for;
m:=0;
for i in [1..126] do if cst[i] ne [] then m:=m+1; end if; end for; m;
for i in [1..#T12124] do [1,2,1,2,4]^T12124[i]; end for;
-----
S:={[1,2,1,3,4]};
SS:=S^N;
SS;
SSS:=Setseq(SS);
for i in [1..#SS] do
for g in IN do if ts[1]*ts[2]*ts[1]*ts[3]*ts[4] eq g
*ts[Rep(SSS[i])[1]]*ts[Rep(SSS[i])[2]]*ts[Rep(SSS[i])[3]]
*ts[Rep(SSS[i])[4]]*ts[Rep(SSS[i])[5]]
then print SSS[i]; end if; end for; end for;
N12134:=Stabiliser(N, [1,2,1,3,4]);
#N12134;
Orbits(N12134);
#SSS;

```



```

T12134:=Transversal(N,N12134);
for i in [1..#T12134] do
ss:=[1,2,1,3,4]^T12134[i];
cst[prodim(1, ts, ss)] := ss;
end for;
m:=0;
for i in [1..126] do if cst[i] ne [] then m:=m+1; end if; end for; m;
for i in [1..#T12134] do [1,2,1,3,4]^T12134[i]; end for;
-----

S:={[1,2,1,3,1]};
SS:=S^N;
SS;
SSS:=Setseq(SS);
for i in [1..#SS] do
for g in IN do if ts[1]*ts[2]*ts[1]*ts[3]*ts[1] eq g
*ts[Rep(SSS[i])[1]]*ts[Rep(SSS[i])[2]]*ts[Rep(SSS[i])[3]]
*ts[Rep(SSS[i])[4]]*ts[Rep(SSS[i])[5]]
then print SSS[i]; end if; end for; end for;
N12131:=Stabiliser(N, [1,2,1,3,1]);
#N12131;
Orbits(N12131);
#SSS;
T12131:=Transversal(N,N12131);
for i in [1..#T12131] do
ss:=[1,2,1,3,1]^T12131[i];
cst[prodim(1, ts, ss)] := ss;
end for;
m:=0;
for i in [1..126] do if cst[i] ne [] then m:=m+1; end if; end for; m;
for i in [1..#T12131] do [1,2,1,3,1]^T12131[i]; end for;
-----

Z:={[1,3,4,2,1]};
ZZ:=Z^N;
ZZ;
ZZZ:=Setseq(ZZ);
for i in [1..#ZZ] do
for g in IN do if ts[1]*ts[3]*ts[4]*ts[2]*ts[1] eq g
*ts[Rep(ZZZ[i])[1]]*ts[Rep(ZZZ[i])[2]]*ts[Rep(ZZZ[i])[3]]
*ts[Rep(ZZZ[i])[4]]*ts[Rep(ZZZ[i])[5]]
then print ZZZ[i]; end if; end for; end for;
N13421:=Stabiliser(N, [1,3,4,2,1]);
N13421;
Orbits(N13421);
#N13421;

```

```

#ZZZ;
T13421:=Transversal(N,N13421);
for i in [1..#T13421] do
ss:=[1,3,4,2,1]^T13421[i];
cst[prodim(1, ts, ss)] := ss;
end for;
m:=0;
for i in [1..126] do if cst[i] ne [] then m:=m+1; end if; end for; m;
for i in [1..#T13421] do [1,3,4,2,1]^T13421[i]; end for;
-----

Z:={[1,3,4,3,4]};
ZZ:=Z^N;
ZZ;
ZZZ:=Setseq(ZZ);
for i in [1..#ZZ] do
for g in IN do if ts[1]*ts[3]*ts[4]*ts[3]*ts[4] eq g
*ts[Rep(ZZZ[i])[1]]*ts[Rep(ZZZ[i])[2]]*ts[Rep(ZZZ[i])[3]]
*ts[Rep(ZZZ[i])[4]]*ts[Rep(ZZZ[i])[5]] then print ZZZ[i];
end if; end for; end for;
N13434:=Stabiliser(N,[1,3,4,3,4]);
N13434;
for g in N do if 1^g eq 2 and 3^g eq 4 and 4^g eq 3
and 3^g eq 4 and 4^g eq 3 then N13434:=sub<N/N13434,g>;
end if; end for; [1,3,4,3,4]^N13434;
Orbits(N13434);
#N13434;
T13434:=Transversal(N,N13434);
for i in [1..#T13434] do
ss:=[1,3,4,3,4]^T13434[i];
cst[prodim(1, ts, ss)] := ss;
end for;
m:=0;
for i in [1..126] do if cst[i] ne [] then m:=m+1; end if; end for; m;
for i in [1..#T13434] do [1,3,4,3,4]^T13434[i]; end for;
-----

Z:={[1,3,4,3,1]};
ZZ:=Z^N;
ZZ;
ZZZ:=Setseq(ZZ);
for i in [1..#ZZ] do
for g in IN do if ts[1]*ts[3]*ts[4]*ts[3]*ts[1] eq g
*ts[Rep(ZZZ[i])[1]]*ts[Rep(ZZZ[i])[2]]*ts[Rep(ZZZ[i])[3]]
*ts[Rep(ZZZ[i])[4]]*ts[Rep(ZZZ[i])[5]]
then print ZZZ[i]; end if; end for; end for;

```

```

N13431:=Stabiliser(N,[1,3,4,3,1]);
N13431;
Orbits(N13431);
#ZZZ;
T13431:=Transversal(N,N13431);
for i in [1..#T13431] do
ss:=[1,3,4,3,1]^T13431[i];
cst[prodim(1, ts, ss)] := ss;
end for;
m:=0;
for i in [1..126] do if cst[i] ne [] then m:=m+1; end if; end for; m;
for i in [1..#T13431] do [1,3,4,3,1]^T13431[i]; end for;
-----
Z:={[1,3,1,2,1]};
ZZ:=Z^N;
ZZ;
ZZZ:=Setseq(ZZ);
for i in [1..#ZZZ] do
for g in IN do if ts[1]*ts[3]*ts[1]*ts[2]*ts[1] eq g
*ts[Rep(ZZZ[i])[1]]*ts[Rep(ZZZ[i])[2]]*ts[Rep(ZZZ[i])[3]]
*ts[Rep(ZZZ[i])[4]]*ts[Rep(ZZZ[i])[5]]
then print ZZZ[i]; end if; end for; end for;
N13121:=Stabiliser(N,[1,3,1,2,1]);
N13121;
Orbits(N13121);
#N13121;
#ZZZ;
T13121:=Transversal(N,N13121);
for i in [1..#T13121] do
ss:=[1,3,1,2,1]^T13121[i];
cst[prodim(1, ts, ss)] := ss;
end for;
m:=0;
for i in [1..126] do if cst[i] ne [] then m:=m+1; end if; end for; m;
for i in [1..#T13121] do [1,3,1,2,1]^T13121[i]; end for;
-----
S:={[1,2,4,3,4,2]};
SS:=S^N;
SS;
SSS:=Setseq(SS);
for i in [1..#SSS] do
for g in IN do if ts[1]*ts[2]*ts[4]*ts[3]*ts[4]*ts[2] eq g
*ts[Rep(SSS[i])[1]]*ts[Rep(SSS[i])[2]]*ts[Rep(SSS[i])[3]]
*ts[Rep(SSS[i])[4]]*ts[Rep(SSS[i])[5]]*ts[Rep(SSS[i])[6]]

```

```

then print SSS[i]; end if; end for; end for;
N124342:=Stabiliser(N, [1,2,4,3,4,2]);
#N124342;
Orbits(N124342);
#SSS;
T124342:=Transversal(N,N124342);
for i in [1..#T124342] do
ss:=[1,2,4,3,4,2]^T124342[i];
cst[prodim(1, ts, ss)] := ss;
end for;
m:=0;
for i in [1..126] do if cst[i] ne [] then m:=m+1; end if; end for; m;
for i in [1..#T124342] do [1,2,4,3,4,2]^T124342[i]; end for;
-----
S:={[1,2,4,3,4,3]};
SS:=S^N;
SS;
SSS:=Setseq(SS);
for i in [1..#SS] do
for g in IN do if ts[1]*ts[2]*ts[4]*ts[3]*ts[4]*ts[3] eq g
*ts[Rep(SSS[i])[1]]*ts[Rep(SSS[i])[2]]*ts[Rep(SSS[i])[3]]
*ts[Rep(SSS[i])[4]]*ts[Rep(SSS[i])[5]]*ts[Rep(SSS[i])[6]]
then print SSS[i]; end if; end for; end for;
N124343:=Stabiliser(N, [1,2,4,3,4,3]);
#N124343;
Orbits(N124343);
#SSS;
T124343:=Transversal(N,N124343);
for i in [1..#T124343] do
ss:=[1,2,4,3,4,3]^T124343[i];
cst[prodim(1, ts, ss)] := ss;
end for;
m:=0;
for i in [1..126] do if cst[i] ne [] then m:=m+1; end if; end for; m;
for i in [1..#T124343] do [1,2,4,3,4,3]^T124343[i]; end for;
-----
S:={[1,2,4,3,1,2]};
SS:=S^N;
SS;
SSS:=Setseq(SS);
for i in [1..#SS] do
for g in IN do if ts[1]*ts[2]*ts[4]*ts[3]*ts[1]*ts[2] eq g
*ts[Rep(SSS[i])[1]]*ts[Rep(SSS[i])[2]]*ts[Rep(SSS[i])[3]]
*ts[Rep(SSS[i])[4]]*ts[Rep(SSS[i])[5]]*ts[Rep(SSS[i])[6]]

```

```

then print SSS[i]; end if; end for; end for;
N124312:=Stabiliser(N, [1,2,4,3,1,2]);
#N124312;
Orbits(N124312);
#SSS;
T124312:=Transversal(N,N124312);
for i in [1..#T124312] do
ss:=[1,2,4,3,1,2]^T124312[i];
cst[prodim(1, ts, ss)] := ss;
end for;
m:=0;
for i in [1..126] do if cst[i] ne [] then m:=m+1; end if; end for; m;
for i in [1..#T124312] do [1,2,4,3,1,2]^T124312[i]; end for;
-----
S:={[1,2,4,3,1,3]};
SS:=S^N;
SS;
SSS:=Setseq(SS);
for i in [1..#SS] do
for g in IN do if ts[1]*ts[2]*ts[4]*ts[3]*ts[1]*ts[3] eq g
*ts[Rep(SSS[i])[1]]*ts[Rep(SSS[i])[2]]*ts[Rep(SSS[i])[3]]
*ts[Rep(SSS[i])[4]]*ts[Rep(SSS[i])[5]]*ts[Rep(SSS[i])[6]]
then print SSS[i]; end if; end for; end for;
N124313:=Stabiliser(N, [1,2,4,3,1,3]);
#N124313;
Orbits(N124313);
#SSS;
T124313:=Transversal(N,N124313);
for i in [1..#T124313] do
ss:=[1,2,4,3,1,3]^T124313[i];
cst[prodim(1, ts, ss)] := ss;
end for;
m:=0;
for i in [1..126] do if cst[i] ne [] then m:=m+1; end if; end for; m;
for i in [1..#T124313] do [1,2,4,3,1,3]^T124313[i]; end for;
-----
S:={[1,2,1,3,4,2]};
SS:=S^N;
SS;
SSS:=Setseq(SS);
for i in [1..#SS] do
for g in IN do if ts[1]*ts[2]*ts[1]*ts[3]*ts[4]*ts[2] eq g
*ts[Rep(SSS[i])[1]]*ts[Rep(SSS[i])[2]]*ts[Rep(SSS[i])[3]]
*ts[Rep(SSS[i])[4]]*ts[Rep(SSS[i])[5]]*ts[Rep(SSS[i])[6]]

```

```

then print SSS[i]; end if; end for; end for;
N121342:=Stabiliser(N,[1,2,1,3,4,2]);
#N121342;
for g in N do if 1^g eq 3 and 2^g eq 4 and 1^g eq 3 and
3^g eq 1 and 4^g eq 2 and 2^g eq 4 then N121342:=sub<N/N121342,g>;
end if; end for;
[1,2,1,3,4,2]^N121342;
Orbits(N121342);
#N121342;
T121342:=Transversal(N,N121342);
for i in [1..#T121342] do
ss:=[1,2,1,3,4,2]^T121342[i];
cst[prodim(1, ts, ss)] := ss;
end for;
m:=0;
for i in [1..126] do if cst[i] ne [] then m:=m+1; end if; end for; m;
for i in [1..#T121342] do [1,2,1,3,4,2]^T121342[i]; end for;
-----

S:={[1,2,1,3,4,3]};
SS:=S^N;
SS;
SSS:=Setseq(SS);
for i in [1..#SS] do
for g in IN do if ts[1]*ts[2]*ts[1]*ts[3]*ts[4]*ts[3] eq g
*ts[Rep(SSS[i])[1]]*ts[Rep(SSS[i])[2]]*ts[Rep(SSS[i])[3]]
*ts[Rep(SSS[i])[4]]*ts[Rep(SSS[i])[5]]*ts[Rep(SSS[i])[6]]
then print SSS[i]; end if; end for; end for;
N121343:=Stabiliser(N,[1,2,1,3,4,3]);
#N121343;
for g in N do if 1^g eq 3 and 2^g eq 4 and 1^g eq 3 and
3^g eq 1 and 4^g eq 2 and 2^g eq 4 then N121342:=sub<N/N121342,g>;
end if; end for;
[1,2,1,3,4,3]^N121343;
Orbits(N121343);
#N121343;
T121343:=Transversal(N,N121343);
for i in [1..#T121343] do
ss:=[1,2,1,3,4,3]^T121343[i];
cst[prodim(1, ts, ss)] := ss;
end for;
m:=0;
for i in [1..126] do if cst[i] ne [] then m:=m+1; end if; end for; m;
for i in [1..#T121343] do [1,2,1,3,4,3]^T121343[i]; end for;
-----

```

```

S:={[1,3,4,2,1,2]};
SS:=S^N;
SS;
SSS:=Setseq(SS);
for i in [1..#SS] do
for g in IN do if ts[1]*ts[3]*ts[4]*ts[2]*ts[1]*ts[2] eq g
*ts[Rep(SSS[i])[1]]*ts[Rep(SSS[i])[2]]*ts[Rep(SSS[i])[3]]
*ts[Rep(SSS[i])[4]]*ts[Rep(SSS[i])[5]]*ts[Rep(SSS[i])[6]]
then print SSS[i]; end if; end for; end for;
N134212:=Stabiliser(N,[1,3,4,2,1,2]);
#N134212;
for g in N do if 1^g eq 2 and 3^g eq 4 and 4^g eq 3 and
2^g eq 1 and 1^g eq 2 and 2^g eq 1 then
N134212:=sub<N|N134212,g>; end if; end for;
[1,3,4,2,1,2]^N134212;
Orbits(N134212);
#N134212;
Set(SSS);
T134212:=Transversal(N,N134212);
for i in [1..#T134212] do
ss:=[1,3,4,2,1,2]^T134212[i];
cst[prodim(1, ts, ss)] := ss;
end for;
m:=0;
for i in [1..126] do if cst[i] ne [] then m:=m+1; end if; end for; m;
for i in [1..#T134212] do [1,3,4,2,1,2]^T134212[i]; end for;
-----

S:={[1,3,4,2,1,3]};
SS:=S^N;
SS;
SSS:=Setseq(SS);
for i in [1..#SS] do
for g in IN do if ts[1]*ts[3]*ts[4]*ts[2]*ts[1]*ts[3] eq g
*ts[Rep(SSS[i])[1]]*ts[Rep(SSS[i])[2]]*ts[Rep(SSS[i])[3]]
*ts[Rep(SSS[i])[4]]*ts[Rep(SSS[i])[5]]*ts[Rep(SSS[i])[6]]
then print SSS[i]; end if; end for; end for;
N134213:=Stabiliser(N,[1,3,4,2,1,3]);
#N134213;
Orbits(N134213);
#SSS;
T134213:=Transversal(N,N134213);
for i in [1..#T134213] do
ss:=[1,3,4,2,1,3]^T134213[i];
cst[prodim(1, ts, ss)] := ss;

```

```

end for;
m:=0;
for i in [1..126] do if cst[i] ne [] then m:=m+1; end if; end for; m;
for i in [1..#T134213] do [1,3,4,2,1,3]^T134213[i]; end for;
-----
S:={[1,3,4,3,1,2]};
SS:=S^N;
SS;
SSS:=Setseq(SS);
for i in [1..#SS] do
for g in IN do if ts[1]*ts[3]*ts[4]*ts[3]*ts[1]*ts[2] eq g
*ts[Rep(SSS[i])[1]]*ts[Rep(SSS[i])[2]]*ts[Rep(SSS[i])[3]]
*ts[Rep(SSS[i])[4]]*ts[Rep(SSS[i])[5]]*ts[Rep(SSS[i])[6]]
then print SSS[i]; end if; end for; end for;
N134312:=Stabiliser(N, [1,3,4,3,1,2]);
#N134312;
Orbits(N134312);
#SSS;
T134312:=Transversal(N, N134312);
for i in [1..#T134312] do
ss:=[1,3,4,3,1,2]^T134312[i];
cst[prodim(1, ts, ss)] := ss;
end for;
m:=0;
for i in [1..126] do if cst[i] ne [] then m:=m+1; end if; end for; m;
for i in [1..#T134312] do [1,3,4,3,1,2]^T134312[i]; end for;
-----
S:={[1,2,4,3,4,3,1]};
SS:=S^N;
SS;
SSS:=Setseq(SS);
for i in [1..#SS] do
for g in IN do if ts[1]*ts[2]*ts[4]*ts[3]*ts[4]*ts[3]*ts[1] eq g
*ts[Rep(SSS[i])[1]]*ts[Rep(SSS[i])[2]]*ts[Rep(SSS[i])[3]]
*ts[Rep(SSS[i])[4]]*ts[Rep(SSS[i])[5]]*ts[Rep(SSS[i])[6]]
*ts[Rep(SSS[i])[7]] then print SSS[i]; end if; end for; end for;
N1243431:=Stabiliser(N, [1,2,4,3,4,3,1]);
#N1243431;
Orbits(N1243431);
#SSS;
T1243431:=Transversal(N, N1243431);
for i in [1..#T1243431] do
ss:=[1,2,4,3,4,3,1]^T1243431[i];
cst[prodim(1, ts, ss)] := ss;

```



```

end for;
m:=0;
for i in [1..126] do if cst[i] ne [] then m:=m+1; end if; end for; m;
for i in [1..#T1243431] do [1,2,4,3,4,3,1]^T1243431[i]; end for;
-----
S:={[1,2,4,3,4,2,1]};
SS:=S^N;
SS;
SSS:=Setseq(SS);
for i in [1..#SS] do
for g in IN do if ts[1]*ts[2]*ts[4]*ts[3]*ts[4]*ts[2]*ts[1] eq
g*ts[Rep(SSS[i])[1]]*ts[Rep(SSS[i])[2]]*ts[Rep(SSS[i])[3]]
*ts[Rep(SSS[i])[4]]*ts[Rep(SSS[i])[5]]*ts[Rep(SSS[i])[6]]
*ts[Rep(SSS[i])[7]] then print SSS[i]; end if; end for; end for;
N1243421:=Stabiliser(N,[1,2,4,3,4,2,1]);
#N1243421;
for g in N do if 1^g eq 2 and 2^g eq 1 and 4^g eq 3 and
3^g eq 4 and 4^g eq 3 and 2^g eq 1 and 1^g eq 2 then
N1243421:=sub<N|N1243421,g>; end if; end for;
for g in N do if 1^g eq 3 and 2^g eq 4 and 4^g eq 2 and
3^g eq 1 and 4^g eq 2 and 2^g eq 4 and 1^g eq 3 then
N1243421:=sub<N|N1243421,g>; end if; end for;
for g in N do if 1^g eq 4 and 2^g eq 3 and 4^g eq 1 and
3^g eq 2 and 4^g eq 1 and 2^g eq 3 and 1^g eq 4 then
N1243421:=sub<N|N1243421,g>; end if; end for;
[1,2,4,3,4,2,1]^N1243421;
Orbits(N1243421);
#N1243421;
T1243421:=Transversal(N,N1243421);
for i in [1..#T1243421] do
ss:=[1,2,4,3,4,2,1]^T1243421[i];
cst[prodim(1,ts,ss)] := ss;
end for;
m:=0;
for i in [1..126] do if cst[i] ne [] then m:=m+1; end if; end for; m;
for i in [1..#T1243421] do [1,2,4,3,4,2,1]^T1243421[i]; end for;
-----
S:={[1,2,4,3,1,2,4]};
SS:=S^N;
SS;
SSS:=Setseq(SS);
for i in [1..#SS] do
for g in IN do if ts[1]*ts[2]*ts[4]*ts[3]*ts[1]*ts[2]*ts[4] eq
g*ts[Rep(SSS[i])[1]]*ts[Rep(SSS[i])[2]]*ts[Rep(SSS[i])[3]]

```

```

*ts[Rep(SSS[i])[4]]*ts[Rep(SSS[i])[5]]*ts[Rep(SSS[i])[6]]
*ts[Rep(SSS[i])[7]] then print SSS[i]; end if; end for; end for;
N1243124:=Stabiliser(N,[1,2,4,3,1,2,4]);
#N1243124;
Orbits(N1243124);
#SSS;
T1243124:=Transversal(N,N1243124);
for i in [1..#T1243124] do
ss:=[1,2,4,3,1,2,4]^T1243124[i];
cst[prodim(1, ts, ss)] := ss;
end for;
m:=0;
for i in [1..126] do if cst[i] ne [] then m:=m+1; end if; end for; m;
for i in [1..#T1243124] do [1,2,4,3,1,2,4]^T1243124[i]; end for;

```

## Appendix B

### MAGMA Code for DCE of $L_2(13)$

#### Over $M$ and $N$

```

/*First, we want to factor the group by the Maximal Subgroup
to find simple group*/
S:=Sym(4);
xx:=S!(1,2)(3,4);
yy:=S!(1,3)(2,4);
N:=sub<S|xx,yy>;
G<x,y,t>:=Group<x,y,t/x^2,y^2,(x,y),t^2,(x*y*x*t)^7,(x*t)^3,
(x*y*t)^13>;
f,G1,k:=CosetAction(G,sub<G|x,y>);
#G1, #k;
CompositionFactors(G1);
IsSimple(G1);
M:=MaximalSubgroups(G1);
M;
/*We look after f(x) and f(y) in one Maximal Subgroup*/
for j in [1..4] do
C:=Conjugates(G1,M[j]'subgroup);
CC:=SetToSequence(C);
for i in [1..#CC] do if f(x) in CC[i] and f(y) in CC[i] then j,i;
end if; end for; end for;
CompositionFactors(M[2]'subgroup);
CompositionFactors(M[3]'subgroup);
C:=Conjugates(G1,M[2]'subgroup);
CC:=SetToSequence(C);
for i in [1..#CC] do if f(x) in CC[i] and f(y) in CC[i] then i;
end if; end for;

```

```

H:=sub<G1|CC[32]>;
#H;
c:=Classes(G1);
c[2][1];
c[3][1];
for g in Class(G1,c[2][3]) do if sub<G1|f(x),f(y),g> eq H then gg:=g;
end if; end for;
gg;
/*After we find the f(x), f(y), and the new relation which factor the
group from the Maximal subgroup, we will use the Background in Magma
to know which is this element call*/
gg:=G1!(1, 269)(2, 244)(3, 200)(4, 201)(5, 249)(6, 165)(7, 255)
(8, 120)(9, 121)(10, 185)(11, 186)(12, 171)(13, 96)(14, 260)
(15, 152)(16, 194)(17, 92)(18, 88)(19, 258)(20, 70)(21, 71)
(22, 265)(23, 267)(24, 102)(25, 253)(26, 254)(27, 158)(28, 53)
(29, 256)(30, 239)(31, 179)(32, 196)(33, 191)(34, 114)(35, 59)
(36, 168)(37, 77)(38, 78)(39, 245)(40, 246)(43, 203)(44, 202)
(45, 211)(46, 212)(47, 175)(49, 155)(50, 233)(51, 232)(52, 224)
(54, 166)(55, 222)(56, 116)(57, 132)(58, 105)(60, 136)(61, 137)
(62, 181)(63, 208)(66, 99)(67, 125)(68, 126)(69, 251)(72, 123)
(73, 122)(74, 107)(75, 84)(76, 217)(79, 157)(80, 187)(81, 193)
(82, 225)(83, 159)(85, 145)(86, 144)(87, 180)(89, 153)(90, 264)
(91, 174)(93, 220)(94, 219)(95, 209)(98,177)(100, 143)(101,127)
(103, 240)(104, 188)(106, 115)(108, 160)(109, 161)(110, 111)
(112, 154)(113, 129)(117, 205)(118, 206)(119, 263)(124, 142)
(128, 147)(130, 164)(131, 204)(133, 207)(134, 236)(135, 230)
(138, 170)(139, 235)(140, 178)(141, 243)(146, 195)(148, 270)
(149, 173)(150, 238)(151, 189)(156, 231)(162, 262)(163, 271)
(167, 192)(169, 218)(172, 266)(182, 250)(183, 184)(190, 237)
(197, 273)(198, 252)(199, 216)(210, 257)(213, 214)(215, 261)
(221, 272)(223, 228)(226, 248)(227, 241)(229, 268)(234, 259);
ts:=[f(t),f(t^x),f(t^y),f(t^(x*y))];
IN:=sub<G1|f(x),f(y)>;

for i,j,k,l,m,n,o,p,q,r,a,b,c,d,e,s,w,z in [0,1] do
if gg eq f(x^i*y^j*t^k*(t^x)^l*(t^y)^m*((t^x)^y)^n*t^o*(t^x)^p
*(t^y)^q*((t^x)^y)^r*t^a*(t^x)^b*(t^y)^c*((t^x)^y)^d*t^e*
(t^x)^s*(t^y)^w*((t^x)^y)^z then i,j,k,l,m,n,o,p,q,r,a,b,
c,d,e,s,w,z; end if; end for;
0 1 1 0 1 0 0 1 1 0 1 0 0 1 1 0 1 0
0 1 1 0 1 0 0 1 1 0 1 0 1 1 0 1 1 1
0 1 1 0 1 0 0 1 1 0 1 0 1 1 1 1 1 0
:
:

```

```

gg eq f(y*t*(t^y)*(t^x)*(t^y)*t*((t^x)^y)*t*(t^y));

M:=sub<G/x,y,y*t*(t^y)*(t^x)*(t^y)*t*((t^x)^y)*t*(t^y)>;
#M;
f,M1,k:=CosetAction(G,M);
#M1; #k;
#DoubleCosets(G,M,sub<G/x,y>);
IsSimple(G1);
IsTransitive(G1);
IsPrimitive(G1);
CompositionFactors(M1);

/*We will state to prove the DCE*/
(DCE of (G,M,sub<G/x,y>))

S:=Sym(4);
xx:=S!(1,2)(3,4);
yy:=S!(1,3)(2,4);
N:=sub<S/xx,yy>;
G<x,y,t>:=Group<x,y,t/x^2,y^2,(x,y),t^2,(x*y*x*t)^7,(x*t)^3,
(x*y*t)^13>;
f,G1,k:=CosetAction(G,sub<G/x,y>);
#G1, #k;
CompositionFactors(G1);
ts=[f(t),f(t^x),f(t^y),f(t^(x*y))];
IN:=sub<G1/f(x),f(y)>;
M:=sub<G/x,y,y*t*(t^y)*(t^x)*(t^y)*t*((t^x)^y)*t*(t^y)>;
#M;
IM:=sub<G1/f(x),f(y),f(y*t*(t^y)*(t^x)*(t^y)*t*((t^x)^y)*t*(t^y))>;
f,G1,k:=CosetAction(G,M);
#G1; #k;
#DoubleCosets(G,M,sub<G/x,y>);
IsSimple(G1);
IsTransitive(G1);
IsPrimitive(G1);
AllPartitions(G1);

Sch:=SchreierSystem(G,sub<G/Id(G)>);
ArrayP:=[Id(N): i in [1..1092]];
for i in [2..1092] do
P:=[Id(N): l in [1..#Sch[i]]];
for j in [1..#Sch[i]] do
if Eltseq(Sch[i])[j] eq 1 then P[j]:=xx; end if;
if Eltseq(Sch[i])[j] eq 2 then P[j]:=yy; end if;

```

```

end for;
PP:=Id(N);
for k in [1..#P] do
PP:=PP*P[k]; end for;
ArrayP[i]:=PP;
end for;
ts:=[f(t),f(t^x),f(t^y),f(t^(x*y))];
IN:=sub<G1|f(x),f(y)>;
IM:=sub<G1|f(x),f(y),f(y*t*(t^y)*(t^x)*(t^y)*t*((t^x)^y)*t*(t^y))>;
  prodim := function(pt, Q, I)
/*
Return the image of pt under permutations Q[I] applied sequentially.
*/
v := pt;
for i in I do
v := v^(Q[i]);
end for;
return v;
end function;

per2sym := function(G1,N, p)
  ww := cst[1^p];
  tt := p * %*[G1|ts[ww[#ww - l + 1]]: l in [1 .. #ww]];
  zz := N![rep{j: j in [1..4] | (1^ts[i])^tt eq 1^ts[j]}:
i in [1..4]]; return <zz, ww>;
end function;
cst := [null : i in [1 ..91]] where null is [Integers() | ];
for i := 1 to 4 do
cst[prodim(1, ts, [i])] := [i];
end for;
m:=0;
for i in [1..91] do if cst[i] ne [] then m:=m+1; end if; end for; m;
N1:=Stabiliser(N,1);
Orbits(N1);
#N1;
-----
S:={[1,3]};
SS:=S^N;
SS;
SSS:=Setseq(SS);
for i in [1..#SS] do
for g in IM do if ts[1]*ts[3] eq g*ts[Rep(SSS[i])[1]]*
ts[Rep(SSS[i])[2]]then print SSS[i]; end if; end for;
end for;

```

```

N13:=Stabiliser(N,[1,3]);
#N13;
Orbits(N13);
#SSS;
T13:=Transversal(N,N13);
for i in [1..#T13] do
ss:=[1,3]^T13[i];
cst[prodim(1, ts, ss)] := ss;
end for;
m:=0;
for i in [1..91] do if cst[i] ne [] then m:=m+1; end if;
end for; m; for i in [1..#T13] do [1,3]^T13[i]; end for;
-----

S:={[1,4]};
SS:=S^N;
SS;
SSS:=Setseq(SS);
for i in [1..#SS] do
for g in IM do if ts[1]*ts[4] eq g*ts[Rep(SSS[i])[1]]*
ts[Rep(SSS[i])[2]] then print SSS[i]; end if; end for;
end for;
N14:=Stabiliser(N,[1,4]);
#N14;
Orbits(N14);
#SSS;
T14:=Transversal(N,N14);
for i in [1..#T14] do
ss:=[1,4]^T14[i];
cst[prodim(1, ts, ss)] := ss;
end for;
m:=0;
for i in [1..91] do if cst[i] ne [] then m:=m+1; end if;
end for; m;for i in [1..#T14] do [1,4]^T14[i]; end for;
-----

S:={[1,3,1]};
SS:=S^N;
SS;
SSS:=Setseq(SS);
for i in [1..#SS] do
for g in IM do if ts[1]*ts[3]*ts[1] eq g*ts[Rep(SSS[i])[1]]
*ts[Rep(SSS[i])[2]]*ts[Rep(SSS[i])[3]]
then print SSS[i]; end if; end for; end for;
N131:=Stabiliser(N,[1,3,1]);
#N131;

```

```

Orbits(N131);
#SSS;
T131:=Transversal(N,N131);
for i in [1..#T131] do
ss:=[1,3,1]^T131[i];
cst[prodim(1, ts, ss)] := ss;
end for;
m:=0;
for i in [1..91] do if cst[i] ne [] then m:=m+1; end if;
end for; m;
for i in [1..#T131] do [1,3,1]^T131[i]; end for;
-----
S:={[1,3,2]};
SS:=S^N;
SS;
SSS:=Setseq(SS);
for i in [1..#SS] do
for g in IM do if ts[1]*ts[3]*ts[2] eq g*ts[Rep(SSS[i])[1]]*
ts[Rep(SSS[i])[2]]*ts[Rep(SSS[i])[3]]
then print SSS[i]; end if; end for; end for;
N132:=Stabiliser(N,[1,3,2]);
#N132;
Orbits(N132);
#SSS;
T132:=Transversal(N,N132);
for i in [1..#T132] do
ss:=[1,3,2]^T132[i];
cst[prodim(1, ts, ss)] := ss;
end for;
m:=0;
for i in [1..91] do if cst[i] ne [] then m:=m+1; end if;
end for; m; for i in [1..#T132] do [1,3,2]^T132[i]; end for;
-----
S:={[1,4,1]};
SS:=S^N;
SS;
SSS:=Setseq(SS);
for i in [1..#SS] do
for g in IM do if ts[1]*ts[4]*ts[1] eq g*ts[Rep(SSS[i])[1]]*
ts[Rep(SSS[i])[2]]*ts[Rep(SSS[i])[3]]
then print SSS[i]; end if; end for; end for;
N141:=Stabiliser(N,[1,4,1]);
#N141;
Orbits(N141);

```



```

#SSS;
T141:=Transversal(N,N141);
for i in [1..#T141] do
ss:=[1,4,1]^T141[i];
cst[prodim(1, ts, ss)] := ss;
end for;
m:=0;
for i in [1..91] do if cst[i] ne [] then m:=m+1; end if;
end for; m; for i in [1..#T141] do [1,4,1]^T141[i]; end for;
-----

S:={[1,4,2]};
SS:=S^N;
SS;
SSS:=Setseq(SS);
for i in [1..#SS] do
for g in IM do if ts[1]*ts[4]*ts[2] eq g*ts[Rep(SSS[i])[1]]*
ts[Rep(SSS[i])[2]]*ts[Rep(SSS[i])[3]]
then print SSS[i]; end if; end for; end for;
N142:=Stabiliser(N,[1,4,2]);
#N142;
Orbits(N142);
#SSS;
T142:=Transversal(N,N142);
for i in [1..#T142] do
ss:=[1,4,2]^T142[i];
cst[prodim(1, ts, ss)] := ss;
end for;
m:=0;
for i in [1..91] do if cst[i] ne [] then m:=m+1; end if;
end for; m; for i in [1..#T142] do [1,4,2]^T142[i]; end for;
-----

S:={[1,3,1,4]};
SS:=S^N;
SS;
SSS:=Setseq(SS);
for i in [1..#SS] do
for g in IM do if ts[1]*ts[3]*ts[1]*ts[4] eq g*ts[Rep(SSS[i])[1]]
*ts[Rep(SSS[i])[2]]*ts[Rep(SSS[i])[3]]*ts[Rep(SSS[i])[4]]
then print SSS[i]; end if; end for; end for;
N1314:=Stabiliser(N,[1,3,1,4]);
#N1314;
for g in N do if 1^g eq 2 and 3^g eq 4 and 1^g eq 2 and
4^g eq 3 then N1314:=sub<N/N1314,g>; end if; end for;
[1,3,1,4]^N1314;

```

```

Orbits(N1314);
#N1314;
T1314:=Transversal(N,N1314);
for i in [1..#T1314] do
ss:=[1,3,1,4]^T1314[i];
cst[prodim(1, ts, ss)] := ss;
end for;
m:=0;
for i in [1..91] do if cst[i] ne [] then m:=m+1; end if;
end for; m; for i in [1..#T1314] do [1,3,1,4]^T1314[i];
end for;
/*for i in [1..4] do for g in IM do for h in IM do if ts[1]*ts[3]
*ts[1]*ts[4]*ts[i] eq g*(ts[1]*ts[4]*ts[1]*ts[4])^h
then i,g,h; break; end if; end for;end for; end for;
*/
-----
S:={[1,3,2,3]};
SS:=S^N;
SS;
SSS:=Setseq(SS);
for i in [1..#SS] do
for g in IM do if ts[1]*ts[3]*ts[2]*ts[3] eq g*ts[Rep(SSS[i])[1]]
*ts[Rep(SSS[i])[2]]*ts[Rep(SSS[i])[3]]*ts[Rep(SSS[i])[4]]
then print SSS[i]; end if; end for; end for;
N1323:=Stabiliser(N,[1,3,2,3]);
#N1323;
for g in N do if 1^g eq 3 and 3^g eq 1 and 2^g eq 4 and
3^g eq 1 then N1323:=sub<N/N1323,g>; end if; end for;
[1,3,2,3]^N1323;
Orbits(N1323);
#N1323;
T1323:=Transversal(N,N1323);
for i in [1..#T1323] do
ss:=[1,3,2,3]^T1323[i];
cst[prodim(1, ts, ss)] := ss;
end for;
m:=0;
for i in [1..91] do if cst[i] ne [] then m:=m+1; end if;
end for; m; for i in [1..#T1323] do [1,3,2,3]^T1323[i];
end for;
-----
S:={[1,3,2,4]};
SS:=S^N;
SS;

```

```

SSS:=Setseq(SS);
for i in [1..#SS] do
for g in IM do if ts[1]*ts[3]*ts[2]*ts[4] eq g*ts[Rep(SSS[i])[1]]
*ts[Rep(SSS[i])[2]]*ts[Rep(SSS[i])[3]]*ts[Rep(SSS[i])[4]]
then print SSS[i]; end if; end for; end for;
N1324:=Stabiliser(N,[1,3,2,4]);
#N1324;
Orbits(N1324);
#SSS;
T1324:=Transversal(N,N1324);
for i in [1..#T1324] do
ss:=[1,3,2,4]^T1324[i];
cst[prodim(1, ts, ss)] := ss;
end for;
m:=0;
for i in [1..91] do if cst[i] ne [] then m:=m+1; end if;
end for; m; for i in [1..#T1324] do [1,3,2,4]^T1324[i];
end for;
-----
S:={[1,4,1,3]};
SS:=S^N;
SS;
SSS:=Setseq(SS);
for i in [1..#SS] do
for g in IM do if ts[1]*ts[4]*ts[1]*ts[3] eq g*ts[Rep(SSS[i])[1]]
*ts[Rep(SSS[i])[2]]*ts[Rep(SSS[i])[3]]*ts[Rep(SSS[i])[4]]
then print SSS[i]; end if; end for; end for;
N1413:=Stabiliser(N,[1,4,1,3]);
#N1413;
Orbits(N1413);
#SSS;
T1413:=Transversal(N,N1413);
for i in [1..#T1413] do
ss:=[1,4,1,3]^T1413[i];
cst[prodim(1, ts, ss)] := ss;
end for;
m:=0;
for i in [1..91] do if cst[i] ne [] then m:=m+1; end if; end for; m;
for i in [1..#T1413] do [1,4,1,3]^T1413[i]; end for;

for i in [1..4] do for g in IM do for h in IM do if ts[1]*ts[4]
*ts[1]*ts[3]*ts[i] eq g*(ts[1]*ts[4]*ts[1]*ts[3])^h
then i,g,h; break; end if; end for;end for; end for;
-----

```

```

S:={[1,4,1,4]};
SS:=S^N;
SS;
SSS:=Setseq(SS);
for i in [1..#SS] do
for g in IM do if ts[1]*ts[4]*ts[1]*ts[4] eq g*ts[Rep(SSS[i])[1]]
*ts[Rep(SSS[i])[2]]*ts[Rep(SSS[i])[3]]*ts[Rep(SSS[i])[4]]
then print SSS[i]; end if; end for; end for;
N1414:=Stabiliser(N,[1,4,1,4]);
#N1414;
Orbits(N1414);
#SSS;
T1414:=Transversal(N,N1414);
for i in [1..#T1414] do
ss:=[1,4,1,4]^T1414[i];
cst[prodim(1, ts, ss)] := ss;
end for;
m:=0;
for i in [1..91] do if cst[i] ne [] then m:=m+1; end if;
end for; m; for i in [1..#T1414] do [1,4,1,4]^T1414[i];
end for;

```

---

```

S:={[1,4,2,3]};
SS:=S^N;
SS;
SSS:=Setseq(SS);
for i in [1..#SS] do
for g in IM do if ts[1]*ts[4]*ts[2]*ts[3] eq g*ts[Rep(SSS[i])[1]]
*ts[Rep(SSS[i])[2]]*ts[Rep(SSS[i])[3]]*ts[Rep(SSS[i])[4]]
then print SSS[i]; end if; end for; end for;
N1423:=Stabiliser(N,[1,4,2,3]);
#N1423;
Orbits(N1423);
#SSS;
T1423:=Transversal(N,N1423);
for i in [1..#T1423] do
ss:=[1,4,2,3]^T1423[i];
cst[prodim(1, ts, ss)] := ss;
end for;
m:=0;
for i in [1..91] do if cst[i] ne [] then m:=m+1; end if;
end for; m; for i in [1..#T1423] do [1,4,2,3]^T1423[i];
end for;

```

---

```

S:={[1,4,2,4]};
SS:=S^N;
SS;
SSS:=Setseq(SS);
for i in [1..#SS] do
for g in IM do if ts[1]*ts[4]*ts[2]*ts[4] eq g*ts[Rep(SSS[i])[1]]
*ts[Rep(SSS[i])[2]]*ts[Rep(SSS[i])[3]]*ts[Rep(SSS[i])[4]]
then print SSS[i]; end if; end for; end for;
N1424:=Stabiliser(N,[1,4,2,4]);
#N1424;
for g in N do if 1^g eq 3 and 4^g eq 2 and 2^g eq 4
and 4^g eq 2 then N1424:=sub<N|N1424,g>; end if; end for;
[1,4,2,4]^N1424;
Orbits(N1424);
#N1424;
T1424:=Transversal(N,N1424);
for i in [1..#T1424] do
ss:=[1,4,2,4]^T1424[i];
cst[prodim(1, ts, ss)] := ss;
end for;
m:=0;
for i in [1..91] do if cst[i] ne [] then m:=m+1; end if;
end for; m; for i in [1..#T1424] do [1,4,2,4]^T1424[i];
end for;
-----

S:={[1,3,2,4,1]};
SS:=S^N;
SS;
SSS:=Setseq(SS);
for i in [1..#SS] do
for g in IM do if ts[1]*ts[3]*ts[2]*ts[4]*ts[1] eq g
*ts[Rep(SSS[i])[1]]*ts[Rep(SSS[i])[2]]*ts[Rep(SSS[i])[3]]
*ts[Rep(SSS[i])[4]]*ts[Rep(SSS[i])[5]] then print SSS[i];
end if; end for; end for;
N13241:=Stabiliser(N,[1,3,2,4,1]);
#N13241;
Orbits(N13241);
#SSS;
T13241:=Transversal(N,N13241);
for i in [1..#T13241] do
ss:=[1,3,2,4,1]^T13241[i];
cst[prodim(1, ts, ss)] := ss;
end for;
m:=0;

```

```

for i in [1..91] do if cst[i] ne [] then m:=m+1; end if;
end for; m; for i in [1..#T13241] do [1,3,2,4,1]^T13241[i];
end for;
-----
S:={[1,3,2,4,2]};
SS:=S^N;
SS;
SSS:=Setseq(SS);
for i in [1..#SS] do
for g in IM do if ts[1]*ts[3]*ts[2]*ts[4]*ts[2] eq g
*ts[Rep(SSS[i])[1]]*ts[Rep(SSS[i])[2]]*ts[Rep(SSS[i])[3]]
*ts[Rep(SSS[i])[4]]*ts[Rep(SSS[i])[5]] then print SSS[i];
end if; end for; end for;
N13242:=Stabiliser(N,[1,3,2,4,2]);
#N13242;
Orbits(N13242);
#SSS;
T13242:=Transversal(N,N13242);
for i in [1..#T13242] do
ss:=[1,3,2,4,2]^T13242[i];
cst[prodim(1, ts, ss)] := ss;
end for;
m:=0;
for i in [1..91] do if cst[i] ne [] then m:=m+1; end if;
end for; m; for i in [1..#T13242] do [1,3,2,4,2]^T13242[i];
end for;
-----
S:={[1,4,1,3,2]};
SS:=S^N;
SS;
SSS:=Setseq(SS);
for i in [1..#SS] do
for g in IM do if ts[1]*ts[4]*ts[1]*ts[3]*ts[2] eq g
*ts[Rep(SSS[i])[1]]*ts[Rep(SSS[i])[2]]*ts[Rep(SSS[i])[3]]
*ts[Rep(SSS[i])[4]]*ts[Rep(SSS[i])[5]] then print SSS[i];
end if; end for; end for;
N14132:=Stabiliser(N,[1,4,1,3,2]);
#N14132;
for g in N do if 1^g eq 4 and 4^g eq 1 and 1^g eq 4 and 3^g eq 2
and 2^g eq 3 then N14132:=sub<N|N14132,g>; end if; end for;
[1,4,1,3,2]^N14132;
Orbits(N14132);
#N14132;
T14132:=Transversal(N,N14132);

```

```

for i in [1..#T14132] do
ss:=[1,4,1,3,2]^T14132[i];
cst[prodim(1, ts, ss)] := ss;
end for;
m:=0;
for i in [1..91] do if cst[i] ne [] then m:=m+1; end if;
end for; m; for i in [1..#T14132] do [1,4,1,3,2]^T14132[i];
end for;
-----
S:={[1,4,1,4,1]};
SS:=S^N;
SS;
SSS:=Setseq(SS);
for i in [1..#SS] do
for g in IM do if ts[1]*ts[4]*ts[1]*ts[4]*ts[1] eq g
*ts[Rep(SSS[i])[1]]*ts[Rep(SSS[i])[2]]*ts[Rep(SSS[i])[3]]
*ts[Rep(SSS[i])[4]]*ts[Rep(SSS[i])[5]] then print SSS[i];
end if; end for; end for;
N14141:=Stabiliser(N, [1,4,1,4,1]);
#N14141;
Orbits(N14141);
#SSS;
T14141:=Transversal(N, N14141);
for i in [1..#T14141] do
ss:=[1,4,1,4,1]^T14141[i];
cst[prodim(1, ts, ss)] := ss;
end for;
m:=0;
for i in [1..91] do if cst[i] ne [] then m:=m+1; end if;
end for; m; for i in [1..#T14141] do [1,4,1,4,1]^T14141[i];
end for;
-----
S:={[1,4,1,4,2]};
SS:=S^N;
SS;
SSS:=Setseq(SS);
for i in [1..#SS] do
for g in IM do if ts[1]*ts[4]*ts[1]*ts[4]*ts[2] eq g
*ts[Rep(SSS[i])[1]]*ts[Rep(SSS[i])[2]]*ts[Rep(SSS[i])[3]]
*ts[Rep(SSS[i])[4]]*ts[Rep(SSS[i])[5]] then print SSS[i];
end if; end for; end for;
N14142:=Stabiliser(N, [1,4,1,4,2]);
#N14142;
Orbits(N14142);

```

```

#SSS;
T14142:=Transversal(N,N14142);
for i in [1..#T14142] do
ss:=[1,4,1,4,2]^T14142[i];
cst[prodim(1, ts, ss)] := ss;
end for;
m:=0;
for i in [1..91] do if cst[i] ne [] then m:=m+1; end if;
end for; m; for i in [1..#T14142] do [1,4,1,4,2]^T14142[i];
end for;
-----
S:={[1,4,2,3,1]};
SS:=S^N;
SS;
SSS:=Setseq(SS);
for i in [1..#SS] do
for g in IM do if ts[1]*ts[4]*ts[2]*ts[3]*ts[1] eq g
*ts[Rep(SSS[i])[1]]*ts[Rep(SSS[i])[2]]*ts[Rep(SSS[i])[3]]
*ts[Rep(SSS[i])[4]]*ts[Rep(SSS[i])[5]] then print SSS[i];
end if; end for; end for;
N14231:=Stabiliser(N,[1,4,2,3,1]);
#N14231;
Orbits(N14231);
#SSS;
T14231:=Transversal(N,N14231);
for i in [1..#T14231] do
ss:=[1,4,2,3,1]^T14231[i];
cst[prodim(1, ts, ss)] := ss;
end for;
m:=0;
for i in [1..91] do if cst[i] ne [] then m:=m+1; end if;
end for; m; for i in [1..#T14231] do [1,4,2,3,1]^T14231[i];
end for;
-----
S:={[1,4,2,3,2]};
SS:=S^N;
SS;
SSS:=Setseq(SS);
for i in [1..#SS] do
for g in IM do if ts[1]*ts[4]*ts[2]*ts[3]*ts[2] eq g
*ts[Rep(SSS[i])[1]]*ts[Rep(SSS[i])[2]]*ts[Rep(SSS[i])[3]]
*ts[Rep(SSS[i])[4]]*ts[Rep(SSS[i])[5]] then print SSS[i];
end if; end for; end for;
N14232:=Stabiliser(N,[1,4,2,3,2]);

```



```

#N14232;
for g in N do if 1^g eq 4 and 4^g eq 1 and 2^g eq 3 and 3^g eq
2 and 2^g eq 3 then N14232:=sub<N|N14232,g>; end if; end for;
[1,4,2,3,2]^N14232;
Orbits(N14232);
#N14232;
T14232:=Transversal(N,N14232);
for i in [1..#T14232] do
ss:=[1,4,2,3,2]^T14232[i];
cst[prodim(1, ts, ss)] := ss;
end for;
m:=0;
for i in [1..91] do if cst[i] ne [] then m:=m+1; end if;
end for; m; for i in [1..#T14232] do [1,4,2,3,2]^T14232[i];
end for;
-----
S:={[1,3,2,4,1,3]};
SS:=S^N;
SS;
SSS:=Setseq(SS);
for i in [1..#SS] do
for g in IM do if ts[1]*ts[3]*ts[2]*ts[4]*ts[1]*ts[3] eq g
*ts[Rep(SSS[i])[1]]*ts[Rep(SSS[i])[2]]*ts[Rep(SSS[i])[3]]
*ts[Rep(SSS[i])[4]]*ts[Rep(SSS[i])[5]]*ts[Rep(SSS[i])[6]]
then print SSS[i]; end if; end for; end for;
N132413:=Stabiliser(N,[1,3,2,4,1,3]);
#N132413;
Orbits(N132413);
#SSS;
T132413:=Transversal(N,N132413);
for i in [1..#T132413] do
ss:=[1,3,2,4,1,3]^T132413[i];
cst[prodim(1, ts, ss)] := ss;
end for;
m:=0;
for i in [1..91] do if cst[i] ne [] then m:=m+1; end if;
end for; m; for i in [1..#T132413] do
[1,3,2,4,1,3]^T132413[i]; end for;
-----
S:={[1,3,2,4,1,4]};
SS:=S^N;
SS;
SSS:=Setseq(SS);
for i in [1..#SS] do

```

```

for g in IM do if ts[1]*ts[3]*ts[2]*ts[4]*ts[1]*ts[4] eq g
*ts[Rep(SSS[i])[1]]*ts[Rep(SSS[i])[2]]*ts[Rep(SSS[i])[3]]
*ts[Rep(SSS[i])[4]]*ts[Rep(SSS[i])[5]]*ts[Rep(SSS[i])[6]]
then print SSS[i]; end if; end for; end for;
N132414:=Stabiliser(N,[1,3,2,4,1,4]);
#N132414;
Orbits(N132414);
#SSS;
T132414:=Transversal(N,N132414);
for i in [1..#T132414] do
ss:=[1,3,2,4,1,4]^T132414[i];
cst[prodim(1, ts, ss)] := ss;
end for;
m:=0;
for i in [1..91] do if cst[i] ne [] then m:=m+1; end if;
end for; m; for i in [1..#T132414] do
[1,3,2,4,1,4]^T132414[i]; end for;
-----

S:={[1,4,1,4,1,4]};
SS:=S^N;
SS;
SSS:=Setseq(SS);
for i in [1..#SS] do
for g in IM do if ts[1]*ts[4]*ts[1]*ts[4]*ts[1]*ts[4] eq g
*ts[Rep(SSS[i])[1]]*ts[Rep(SSS[i])[2]]*ts[Rep(SSS[i])[3]]
*ts[Rep(SSS[i])[4]]*ts[Rep(SSS[i])[5]]*ts[Rep(SSS[i])[6]]
then print SSS[i]; end if; end for; end for;
N141414:=Stabiliser(N,[1,4,1,4,1,4]);
#N141414;
Orbits(N141414);
#SSS;
T141414:=Transversal(N,N141414);
for i in [1..#T141414] do
ss:=[1,4,1,4,1,4]^T141414[i];
cst[prodim(1, ts, ss)] := ss;
end for;
m:=0;
for i in [1..91] do if cst[i] ne [] then m:=m+1; end if;
end for; m; for i in [1..#T141414] do
[1,4,1,4,1,4]^T141414[i]; end for;
-----

S:={[1,4,1,4,2,4]};
SS:=S^N;
SS;

```

```

SSS:=Setseq(SS);
for i in [1..#SS] do
for g in IM do if ts[1]*ts[4]*ts[1]*ts[4]*ts[2]*ts[4] eq g
*ts[Rep(SSS[i])[1]]*ts[Rep(SSS[i])[2]]*ts[Rep(SSS[i])[3]]
*ts[Rep(SSS[i])[4]]*ts[Rep(SSS[i])[5]]*ts[Rep(SSS[i])[6]]
then print SSS[i]; end if; end for; end for;
N141424:=Stabiliser(N,[1,4,1,4,2,4]);
#N141424;
for g in N do if 1^g eq 2 and 4^g eq 3 and 1^g eq 2 and 4^g eq 3
and 2^g eq 1 and 4^g eq 3 then N141424:=sub<N/N141424,g>;
end if; end for;
[1,4,1,4,2,4]^N141424;
Orbits(N141424);
#N141424;
T141424:=Transversal(N,N141424);
for i in [1..#T141424] do
ss:=[1,4,1,4,2,4]^T141424[i];
cst[prodim(1, ts, ss)] := ss;
end for;
m:=0;
for i in [1..91] do if cst[i] ne [] then m:=m+1; end if;
end for; m; for i in [1..#T141424] do [1,4,1,4,2,4]^T141424[i];
end for;
-----
S:={[1,3,2,4,1,3,2]};
SS:=S^N;
SS;
SSS:=Setseq(SS);
for i in [1..#SS] do
for g in IM do if ts[1]*ts[3]*ts[2]*ts[4]*ts[1]*ts[3]*ts[2] eq g
*ts[Rep(SSS[i])[1]]*ts[Rep(SSS[i])[2]]*ts[Rep(SSS[i])[3]]
*ts[Rep(SSS[i])[4]]*ts[Rep(SSS[i])[5]]*ts[Rep(SSS[i])[6]]
*ts[Rep(SSS[i])[7]]
then print SSS[i]; end if; end for; end for;
N1324132:=Stabiliser(N,[1,3,2,4,1,3,2]);
#N1324132;
for g in N do if 1^g eq 2 and 3^g eq 4 and 2^g eq 1 and 4^g eq 3
and 1^g eq 2 and 3^g eq 4 and 2^g eq 1 then
N1324132:=sub<N/N1324132,g>; end if; end for;
for g in N do if 1^g eq 3 and 3^g eq 1 and 2^g eq 4 and 4^g eq 2
and 1^g eq 3 and 3^g eq 1 and 2^g eq 4 then
N1324132:=sub<N/N1324132,g>; end if; end for;
for g in N do if 1^g eq 4 and 3^g eq 2 and 2^g eq 3 and 4^g eq 1
and 1^g eq 4 and 3^g eq 2 and 2^g eq 3 then

```

```

N1324132:=sub<N/N1324132,g>; end if; end for;
[1,3,2,4,1,3,2]^N1324132;
Orbits(N1324132);
#N1324132;
N1324132;
T1324132:=Transversal(N,N1324132);
for i in [1..#T1324132] do
ss:=[1,3,2,4,1,3,2]^T1324132[i];
cst[prodim(1, ts, ss)] := ss;
end for;
m:=0;
for i in [1..91] do if cst[i] ne [] then m:=m+1; end if; end for; m;
for i in [1..#T1324132] do [1,3,2,4,1,3,2]^T1324132[i]; end for;
-----
S:={[1,4,1,4,1,4,2]};
SS:=S^N;
SS;
SSS:=Setseq(SS);
for i in [1..#SS] do
for g in IM do if ts[1]*ts[4]*ts[1]*ts[4]*ts[1]*ts[4]*ts[2] eq g
*ts[Rep(SSS[i])[1]]*ts[Rep(SSS[i])[2]]*ts[Rep(SSS[i])[3]]
*ts[Rep(SSS[i])[4]]*ts[Rep(SSS[i])[5]]*ts[Rep(SSS[i])[6]]
*ts[Rep(SSS[i])[7]]
then print SSS[i]; end if; end for; end for;
N1414142:=Stabiliser(N,[1,4,1,4,1,4,2]);
#N1414142;
for g in N do if 1^g eq 2 and 4^g eq 3 and 1^g eq 2 and 4^g eq 3
and 1^g eq 2 and 4^g eq 3 and 2^g eq 1 then
N1414142:=sub<N/N1414142,g>; end if; end for;
for g in N do if 1^g eq 3 and 4^g eq 2 and 1^g eq 3 and 4^g eq 2
and 1^g eq 3 and 4^g eq 2 and 2^g eq 4 then
N1414142:=sub<N/N1414142,g>; end if; end for;
for g in N do if 1^g eq 4 and 4^g eq 1 and 1^g eq 4 and 4^g eq 1
and 1^g eq 4 and 4^g eq 1 and 2^g eq 3 then
N1414142:=sub<N/N1414142,g>; end if; end for;
[1,4,1,4,1,4,2]^N1414142;
Orbits(N1414142);
#N1414142;
T1414142:=Transversal(N,N1414142);
for i in [1..#T1414142] do
ss:=[1,4,1,4,1,4,2]^T1414142[i];
cst[prodim(1, ts, ss)] := ss;
end for;
m:=0;

```

```

for i in [1..91] do if cst[i] ne [] then m:=m+1; end if; end for; m;
-----
/*We will find some relations from the single cosets*/
for i in [1..#T1414142] do [1,4,1,4,1,4,2]^T1414142[i]; end for;
for i in [1..4] do for g in IM do for h in IN do if
ts[1]*ts[3]*ts[i] eq g*(ts[1]*ts[4])^h then i,g,h; break;
end if; end for;end for; end for;

for i in [1..4] do for g in IM do for h in IN do if
ts[1]*ts[3]*ts[1]*ts[i] eq g*(ts[1]*ts[3]*ts[2])^h then i,g,h;
break; end if; end for;end for; end for;

for i in [1..4] do for g in IM do for h in IN do if
ts[1]*ts[3]*ts[1]*ts[4]*ts[i] eq g*(ts[1]*ts[3]*ts[1]*ts[4])^h
then i,g,h; break; end if; end for;end for; end for;

for i in [1..4] do for g in IM do for h in IM do if
ts[1]*ts[4]*ts[1]*ts[3]*ts[i] eq g*(ts[1]*ts[3]*ts[2]*ts[4]*ts[2])^h
then i,g,h; break; end if; end for;end for; end for;

for i in [1..4] do for g in IM do for h in IN do if
ts[1]*ts[4]*ts[1]*ts[4]*ts[1]*ts[i] eq g*(ts[1]*ts[3]*ts[2]*ts[4]
*ts[1]*ts[4])^h then i,g,h; break; end if; end for;end for; end for;

for i in [1..4] do for g in IM do for h in IN do if
ts[1]*ts[4]*ts[1]*ts[4]*ts[2]*ts[i] eq g*(ts[1]*ts[4]*ts[1]
*ts[4]*ts[1])^h then i,g,h; break; end if; end for;end for; end for;

for i in [1..4] do for g in IM do for h in IN do if ts[1]*ts[4]*ts[1]
*ts[4]*ts[2]*ts[i] eq g*(ts[1]*ts[4]*ts[1]*ts[4]*ts[2])^h
then i,g,h; break; end if; end for;end for; end for;

for i in [1..4] do for g in IM do for h in IN do if
ts[1]*ts[4]*ts[1]*ts[4]*ts[1]*ts[4]*ts[i] eq g*(ts[1]*ts[4]*ts[1]
*ts[4]*ts[1]*ts[4])^h then i,g,h; break; end if; end for;end for;
end for;

for i in [1..4] do for g in IM do for h in IN do if
ts[1]*ts[4]*ts[1]*ts[4]*ts[1]*ts[4]*ts[i] eq
g*(ts[1]*ts[3]*ts[2]*ts[4]*ts[1]*ts[4])^h
then i,g,h; break; end if; end for;end for; end for;

for i in [1..4] do for g in IM do for h in IN do if
ts[1]*ts[4]*ts[2]*ts[3]*ts[1]*ts[i] eq

```

```

g*(ts[1]*ts[4]*ts[2]*ts[3]*ts[1])^h
then i,g,h; break; end if; end for;end for; end for;

for i in [1..4] do for g in IM do for h in IN do if
ts[1]*ts[3]*ts[2]*ts[4]*ts[1]*ts[4]*ts[i] eq
g*(ts[1]*ts[4]*ts[1]*ts[4]*ts[1])^h
then i,g,h; break; end if; end for;end for; end for;

for i in [1..4] do for g in IM do for h in IN do if
ts[1]*ts[3]*ts[2]*ts[4]*ts[1]*ts[4]*ts[i] eq
g*(ts[1]*ts[4]*ts[1]*ts[4]*ts[1]*ts[4])^h
then i,g,h; break; end if; end for;end for; end for;

/*We use SchreierSystem to give name for that permetations from G*/
N:=G1;
Sch:=SchreierSystem(G,sub<G/Id(G)>);
ArrayP:=[Id(N): i in [1..1092]];
for i in [2..1092] do
P:=[Id(N): l in [1..#Sch[i]]];
for j in [1..#Sch[i]] do
if Eltseq(Sch[i])[j] eq 1 then P[j]:=f(x); end if;
if Eltseq(Sch[i])[j] eq 2 then P[j]:=f(y); end if;
if Eltseq(Sch[i])[j] eq 3 then P[j]:=f(t); end if;
end for;
PP:=Id(N);
for k in [1..#P] do
PP:=PP*P[k]; end for;
ArrayP[i]:=PP;
end for;
for i in [1..1092] do if ArrayP[i] eq N!(2, 32, 56, 5, 19, 40)
(3, 48, 25, 4, 49, 26)(6, 64, 70, 12, 63, 53)(7, 90, 65, 14, 85
, 81)(8, 61, 54, 9, 62, 72)(10, 75, 88, 11, 74, 89)(13, 77, 17,
24, 71, 18)(15, 79, 22, 27, 80, 23)(16, 73, 20, 29, 84, 21)(28,
59, 51, 35, 47, 55)(30, 34, 67, 46, 52, 66)(31, 83, 86, 39, 82,
78)(33, 45, 42, 50, 36, 41)(37, 57, 44, 38, 76, 43)(58, 68, 87)
(60, 69, 91) then; Sch[i]; end if; end for;

```

## Appendix C

# MAGMA Code for DCE of $S_6 \times 2$ Over $S_5$

```

S:=Sym(5);
xx:=S!(1,2,3,4,5);
yy:=S!(1,2);
N:=sub<S|xx,yy>;
G<x,y>:=Group<x,y|x^5,y^2,(x^-1*y)^4,(x*y*x^-2*y*x)^2>;
f,G1,k:=CosetAction(G,sub<G|x,y>);
#G1, #k;
CompositionFactors(G1);
#sub<G|x,y>;
#DoubleCosets(G,sub<G|x,y>,sub<G|x,y>);
IsSimple(G1);
IsTransitive(N);
DoubleCosets(G,sub<G|x,y>,sub<G|x,y>);

Sch:=SchreierSystem(G,sub<G|Id(G)>);
ArrayP:=[Id(N): i in [1..120]];
for i in [2..120] do
P:=[Id(N): l in [1..#Sch[i]]];
for j in [1..#Sch[i]] do
if Eltseq(Sch[i])[j] eq 1 then P[j]:=xx; end if;
if Eltseq(Sch[i])[j] eq -1 then P[j]:=xx^-1; end if;
if Eltseq(Sch[i])[j] eq 2 then P[j]:=yy; end if;
end for;
PP:=Id(N);
for k in [1..#P] do
PP:=PP*P[k]; end for;

```

```

ArrayP[i]:=PP;
end for;
N5:=Stabiliser(N,5);
N5;
for i in [1..120] do if ArrayP[i] eq N!(2, 3) then Sch[i];
end if; end for;

G<x,y,t>:=Group<x,y,t/x^5,y^2,(x^-1*y)^4,(x*y*x^-2*y*x)^2,
t^2,(t,y),(t,y*x^2*y*x*y*x^-1),(t,x^-2*y*x^2),(t,y*x*y*x^2*y*x)
,((y*x*y*x^-1)=t*t^(x)*t^(x^2)*t)>;
f,G1,k:=CosetAction(G,sub<G/x,y>);
#G1, #k;
CompositionFactors(G1);
#sub<G/x,y>;
#DoubleCosets(G,sub<G/x,y>,sub<G/x,y>);
IsTransitive(N);
DoubleCosets(G,sub<G/x,y>,sub<G/x,y>);
for n in N do [5,1,2,5,2,5,1]^n; end for;
ts:=[f(t),f(t^x),f(t^(x^2)),f(t^(x^3)),f(t^(x^4))];
IN:=sub<G1|f(x),f(y)>;
prodim := function(pt, Q, I)
/*
Return the image of pt under permutations Q[I] applied sequentially.
*/
v := pt;
for i in I do
v := v^(Q[i]);
end for;
return v;
end function;

per2sym := function(G1,N, p)
ww := cst[1^p];
tt := p * &*[G1|ts[ww[#ww - l + 1]]: l in [1 .. #ww]];
zz := N![rep{j: j in [1..5] | (1^ts[i])^tt eq 1^ts[j]}:
i in [1..5]]; return <zz, ww>;
end function;

cst := [null : i in [1 ..12]] where null is [Integers() | ];
for i := 1 to 5 do
cst[prodim(1, ts, [i])] := [i];
end for;
m:=0;
for i in [1..12] do if cst[i] ne [] then m:=m+1; end if;

```



```

end for; m;
N5:=Stabiliser(N,5);
Orbits(N5);
#N5;
-----
S:={[5,1]};
SS:=S^N;
SS;
SSS:=Setseq(SS);
for i in [1..#SS] do
for g in IN do if ts[5]*ts[1] eq g*ts[Rep(SSS[i])[1]]
*ts[Rep(SSS[i])[2]] then print SSS[i]; end if; end for;
end for;
N51:=Stabiliser(N,[5,1]);
#N51;
for g in N do if 5^g eq 5 and 1^g eq 2 then N51:=sub<N/N51,g>;
end if; end for;
for g in N do if 5^g eq 5 and 1^g eq 4 then N51:=sub<N/N51,g>;
end if; end for;
for g in N do if 5^g eq 5 and 1^g eq 3 then N51:=sub<N/N51,g>;
end if; end for;
[5,1]^N51;
Orbits(N51);
#N51;
T51:=Transversal(N,N51);
for i in [1..#T51] do
ss:=[5,1]^T51[i];
cst[prodim(1, ts, ss)] := ss;
end for;
m:=0;
for i in [1..12] do if cst[i] ne [] then m:=m+1; end if;
end for; m; for i in [1..#T51] do [5,1]^T51[i]; end for;
-----
S:={[5,1,5]};
SS:=S^N;
SS;
SSS:=Setseq(SS);
for i in [1..#SS] do
for g in IN do if ts[5]*ts[1]*ts[5] eq g*ts[Rep(SSS[i])[1]]
*ts[Rep(SSS[i])[2]]*ts[Rep(SSS[i])[3]] then print SSS[i];
end if; end for; end for;
N515:=Stabiliser(N,[5,1,5]);
#N515;
for g in N do if 5^g eq 1 and 1^g eq 2 and 5^g eq 1 then

```

```

N515:=sub<N/N515,g>; end if; end for;
for g in N do if 5^g eq 5 and 1^g eq 2 and 5^g eq 5 then
  N515:=sub<N/N515,g>; end if; end for;
for g in N do if 5^g eq 2 and 1^g eq 3 and 5^g eq 2 then
  N515:=sub<N/N515,g>; end if; end for;
for g in N do if 5^g eq 2 and 1^g eq 1 and 5^g eq 2 then
  N515:=sub<N/N515,g>; end if; end for;
for g in N do if 5^g eq 1 and 1^g eq 3 and 5^g eq 1 then
  N515:=sub<N/N515,g>; end if; end for;
for g in N do if 5^g eq 3 and 1^g eq 4 and 5^g eq 3 then
  N515:=sub<N/N515,g>; end if; end for;
for g in N do if 5^g eq 3 and 1^g eq 2 and 5^g eq 3 then
  N515:=sub<N/N515,g>; end if; end for;
for g in N do if 5^g eq 2 and 1^g eq 4 and 5^g eq 2 then
  N515:=sub<N/N515,g>; end if; end for;
for g in N do if 5^g eq 4 and 1^g eq 5 and 5^g eq 4 then
  N515:=sub<N/N515,g>; end if; end for;
for g in N do if 5^g eq 4 and 1^g eq 3 and 5^g eq 4 then
  N515:=sub<N/N515,g>; end if; end for;
for g in N do if 5^g eq 3 and 1^g eq 1 and 5^g eq 3 then
  N515:=sub<N/N515,g>; end if; end for;
for g in N do if 5^g eq 3 and 1^g eq 5 and 5^g eq 3 then
  N515:=sub<N/N515,g>; end if; end for;
for g in N do if 5^g eq 1 and 1^g eq 4 and 5^g eq 1 then
  N515:=sub<N/N515,g>; end if; end for;
for g in N do if 5^g eq 5 and 1^g eq 4 and 5^g eq 5 then
  N515:=sub<N/N515,g>; end if; end for;
for g in N do if 5^g eq 4 and 1^g eq 2 and 5^g eq 4 then
  N515:=sub<N/N515,g>; end if; end for;
for g in N do if 5^g eq 4 and 1^g eq 1 and 5^g eq 4 then
  N515:=sub<N/N515,g>; end if; end for;
for g in N do if 5^g eq 2 and 1^g eq 5 and 5^g eq 2 then
  N515:=sub<N/N515,g>; end if; end for;
for g in N do if 5^g eq 1 and 1^g eq 5 and 5^g eq 1 then
  N515:=sub<N/N515,g>; end if; end for;
for g in N do if 5^g eq 5 and 1^g eq 3 and 5^g eq 5 then
  N515:=sub<N/N515,g>; end if; end for;
[5,1,5]^N515;
Orbits(N515);
#N515;
T515:=Transversal(N,N515);
for i in [1..#T515] do
  ss:=[5,1,5]^T515[i];
  cst[prodim(1, ts, ss)] := ss;

```

```
end for;  
m:=0;  
for i in [1..12] do if cst[i] ne [] then m:=m+1; end if;  
end for; m; for i in [1..#T515] do [5,1,5]^T515[i];  
end for;
```

## Appendix D

### MAGMA Code for DCE of

### $M_{22} \times 2$ Over $S_6$

```

S:=Sym(30);
xx:=S!(1, 2, 4, 8)(3, 6, 11, 18, 26, 20, 29, 22)
      (5, 10, 17, 12, 19, 28, 30, 25)(7,13, 21,
27, 15, 24, 23, 14)(9, 16);
yy:=S!(1, 3, 7, 14, 23, 29, 4, 9)(2, 5, 10, 6,
      12, 20, 28, 30)(8, 15, 25, 21)(11,16, 26,
19, 13, 22, 24, 17)(18, 27);
N:=sub<S/xx,yy>;
G<x,y,t>:=Group<x,y,t/x^8,y^8,(x*y^-2*x)^2,(x^-1*y^-1)^4,
(x*y^-1)^4,(y^-1*x^-1*y*x^3*y*x^-1*y^-1*x),(y*x*y*x^3*y*x*y^2),
t^2,(t,x^4),(t,x*y*x^-1*y^-2*x),(t,x*y*x*y*x^-1*y^-1)
,((x^-3)*t^(y^3))^5,((x^-3)*t^(y^7))^4>;
f,G1,k:=CosetAction(G,sub<G/x,y>);
#G1; #k;
CompositionFactors(G1);
Center(G1);
#DoubleCosets(G,sub<G/x,y>,sub<G/x,y>);
#sub<G/x,y>;
Sch:=SchreierSystem(G,sub<G/Id(G)>);
ArrayP:=[Id(N): i in [1..887040]];
for i in [2..887040] do
P:=[Id(N): l in [1..#Sch[i]]];
for j in [1..#Sch[i]] do
if Eltseq(Sch[i])[j] eq 1 then P[j]:=xx; end if;
if Eltseq(Sch[i])[j] eq -1 then P[j]:=xx^-1; end if;
if Eltseq(Sch[i])[j] eq 2 then P[j]:=yy; end if;

```

```

if Eltseq(Sch[i])[j] eq -2 then P[j]:=yy^-1; end if;
end for;
PP:=Id(N);
for k in [1..#P] do
PP:=PP*P[k]; end for;
ArrayP[i]:=PP;
end for;
/*
for n in N do [1, 2, 4, 8,3, 6, 11, 18, 26, 20, 29, 22,5, 10, 17,
12, 19, 28, 30, 25,7, 13, 21, 27, 15, 24, 23, 14,9, 16,27,23,13,
15,14]^n; end for;
for n in N do [3, 26, 2, 19, 6, 20, 7, 15, 10, 28, 11, 29, 12, 25,
13, 24, 14, 27, 17, 30, 18, 22, 21, 23, 16, 9, 16, 9]^n; end for;
*/

ts:=[f(t),f(t^(x)),f(t^(y)),f(t^(x^2)),f(t^(x*y)),f(t^(y*x)),
f(t^(y^2)),f(t^(x^3)),f(t^(y^7)),f(t^(x*(y^2))),f(t^(y*(x^2)))
,f(t^(x*(y^4))),f(t^((y^2)*x)),f(t^(y^3)),f(t^((y^2)*(x^4))),
f(t^((y^7)*x)),f(t^(x*y*(x^2))),f(t^(y*(x^3))),f(t^(x*y*(x^4)))
,f(t^(y*(x^5))),f(t^((x^3)*(y^3))),f(t^(y*(x^7))),f(t^(y^4)),
f(t^((y^2)*(x^5))),f(t^((x^3)*(y^2))),f(t^(y*(x^4))),
f(t^((y^2)*(x^3))),f(t^(x*(y^6))),f(t^(y^5)),f(t^(x*(y^7)))]];
IN:=sub<G1|f(x),f(y)>;
Index(G,sub<G|x,y>);
prodim := function(pt, Q, I)
/*
Return the image of pt under permutations Q[I] applied sequentially.
*/
v := pt;
for i in I do
v := v^(Q[i]);
end for;
return v;
end function;
cst := [null : i in [1..1232]] where null is [Integers() | ];
for i := 1 to 30 do
cst[prodim(1, ts, [i])] := [i];
end for;
m:=0;
for i in [1..1232] do if cst[i] ne [] then m:=m+1; end if;
end for; m;
N1:=Stabiliser(N,1);
Orbits(N1);
#N1;

```

```

-----
S:={[1,2]};
SS:=S^N;
SS;
SSS:=Setseq(SS);
for i in [1..#SS] do
for g in IN do if ts[1]*ts[2] eq g*ts[Rep(SSS[i])[1]]
*ts[Rep(SSS[i])[2]] then print SSS[i]; end if; end for;
end for;
N12:=Stabiliser(N,[1,2]);
#N12;
Orbits(N12);
#SSS;
T12:=Transversal(N,N12);
for i in [1..#T12] do
ss:=[1,2]^T12[i];
cst[prodim(1, ts, ss)] := ss;
end for;
m:=0;
for i in [1..1232] do if cst[i] ne [] then m:=m+1; end if;
end for; m;
-----

S:={[1,3]};
SS:=S^N;
SS;
SSS:=Setseq(SS);
for i in [1..#SS] do
for g in IN do if ts[1]*ts[3] eq g*ts[Rep(SSS[i])[1]]
*ts[Rep(SSS[i])[2]] then print SSS[i]; end if; end for;
end for;
N13:=Stabiliser(N,[1,3]);
#N13;
for g in N do if 1^g eq 3 and 3^g eq 1 then N13:=sub<N/N13,g>;
end if; end for;
[1,3]^N13;
#N13;
Orbits(N13);
T13:=Transversal(N,N13);
for i in [1..#T13] do
ss:=[1,3]^T13[i];
cst[prodim(1, ts, ss)] := ss;
end for;
m:=0;
for i in [1..1232] do if cst[i] ne [] then m:=m+1; end if;

```

```

end for; m;
-----
S:={[1,4]};
SS:=S^N;
SS;
SSS:=Setseq(SS);
for i in [1..#SS] do
for g in IN do if ts[1]*ts[4] eq g*ts[Rep(SSS[i])[1]]
*ts[Rep(SSS[i])[2]] then print SSS[i]; end if; end for;
end for;
N14:=Stabiliser(N,[1,4]);
#N14;
for g in N do if 1^g eq 4 and 4^g eq 1 then
N14:=sub<N|N14,g>; end if; end for;
for g in N do if 1^g eq 18 and 4^g eq 22 then
N14:=sub<N|N14,g>; end if; end for;
for g in N do if 1^g eq 20 and 4^g eq 6 then
N14:=sub<N|N14,g>; end if; end for;
for g in N do if 1^g eq 22 and 4^g eq 8 then
N14:=sub<N|N14,g>; end if; end for;
for g in N do if 1^g eq 6 and 4^g eq 20 then
N14:=sub<N|N14,g>; end if; end for;
[1,4]^N14;
#N14;
Orbits(N14);
T14:=Transversal(N,N14);
for i in [1..#T14] do
ss:=[1,4]^T14[i];
cst[prodim(1, ts, ss)] := ss;
end for;
m:=0;
for i in [1..1232] do if cst[i] ne [] then m:=m+1; end if;
end for; m;
-----
S:={[1,2,3]};
SS:=S^N;
SS;
SSS:=Setseq(SS);
for i in [1..#SS] do
for g in IN do if ts[1]*ts[2]*ts[3] eq g*ts[Rep(SSS[i])[1]]
*ts[Rep(SSS[i])[2]]*ts[Rep(SSS[i])[3]] then print SSS[i];
end if; end for; end for;
N123:=Stabiliser(N,[1,2,3]);
#N123;

```

```

for g in N do if 1^g eq 1 and 2^g eq 8 and 3^g eq 26 then
  N123:=sub<N|N123,g>; end if; end for;
[1,2,3]^N123;
#N123;
Orbits(N123);
T123:=Transversal(N,N123);
for i in [1..#T123] do
  ss:=[1,2,3]^T123[i];
  cst[prodim(1, ts, ss)] := ss;
end for;
m:=0;
for i in [1..1232] do if cst[i] ne [] then m:=m+1; end if;
end for; m;
-----

S:={[1,2,4]};
SS:=S^N;
SS;
SSS:=Setseq(SS);
for i in [1..#SS] do
for g in IN do if ts[1]*ts[2]*ts[4] eq g*ts[Rep(SSS[i])[1]]
*ts[Rep(SSS[i])[2]]*ts[Rep(SSS[i])[3]] then print SSS[i];
end if; end for; end for;
N124:=Stabiliser(N,[1,2,4]);
#N124;
for g in N do if 1^g eq 2 and 2^g eq 1 and 4^g eq 8 then
  N124:=sub<N|N124,g>; end if; end for;
[1,2,4]^N124;
#N124;
Orbits(N124);
T124:=Transversal(N,N124);
for i in [1..#T124] do
  ss:=[1,2,4]^T124[i];
  cst[prodim(1, ts, ss)] := ss;
end for;
m:=0;
for i in [1..1232] do if cst[i] ne [] then m:=m+1; end if;
end for; m;
-----

S:={[1,2,8]};
SS:=S^N;
SS;
SSS:=Setseq(SS);
for i in [1..#SS] do
for g in IN do if ts[1]*ts[2]*ts[8] eq g*ts[Rep(SSS[i])[1]]

```



```

*ts[Rep(SSS[i])[2]]*ts[Rep(SSS[i])[3]] then print SSS[i];
end if; end for; end for;
N128:=Stabiliser(N,[1,2,8]);
#N128;
for g in N do if 1^g eq 9 and 2^g eq 15 and 8^g eq 5 then
  N128:=sub<N|N128,g>; end if; end for;
for g in N do if 1^g eq 1 and 2^g eq 29 and 8^g eq 11 then
  N128:=sub<N|N128,g>; end if; end for;
for g in N do if 1^g eq 9 and 2^g eq 7 and 8^g eq 19 then
  N128:=sub<N|N128,g>; end if; end for;
for g in N do if 1^g eq 9 and 2^g eq 19 and 8^g eq 7 then
  N128:=sub<N|N128,g>; end if; end for;
for g in N do if 1^g eq 1 and 2^g eq 11 and 8^g eq 29 then
  N128:=sub<N|N128,g>; end if; end for;
for g in N do if 1^g eq 9 and 2^g eq 5 and 8^g eq 15 then
  N128:=sub<N|N128,g>; end if; end for;
for g in N do if 1^g eq 1 and 2^g eq 8 and 8^g eq 2 then
  N128:=sub<N|N128,g>; end if; end for;
[1,2,8]^N128;
#N128;
Orbits(N128);
T128:=Transversal(N,N128);
for i in [1..#T128] do
  ss:=[1,2,8]^T128[i];
  cst[prodim(1, ts, ss)] := ss;
end for;
m:=0;
for i in [1..1232] do if cst[i] ne [] then m:=m+1; end if;
end for; m;
-----
S:={[1,2,17]};
SS:=S^N;
SS;
SSS:=Setseq(SS);
for i in [1..#SS] do
for g in IN do if ts[1]*ts[2]*ts[17] eq g*ts[Rep(SSS[i])[1]]
*ts[Rep(SSS[i])[2]]*ts[Rep(SSS[i])[3]] then print SSS[i];
end if; end for; end for;
N1217:=Stabiliser(N,[1,2,17]);
#N1217;
for g in N do if 1^g eq 28 and 2^g eq 16 and 17^g eq 11 then
  N1217:=sub<N|N1217,g>; end if; end for;
for g in N do if 1^g eq 4 and 2^g eq 2 and 17^g eq 7 then
  N1217:=sub<N|N1217,g>; end if; end for;

```

```

for g in N do if 1^g eq 13 and 2^g eq 16 and 17^g eq 26 then
  N1217:=sub<N|N1217,g>; end if; end for;
[1,2,17]^N1217;
#N1217;
Orbits(N1217);
T1217:=Transversal(N,N1217);
for i in [1..#T1217] do
  ss:=[1,2,17]^T1217[i];
  cst[prodim(1, ts, ss)] := ss;
end for;
m:=0;
for i in [1..1232] do if cst[i] ne [] then m:=m+1; end if;
end for; m;
-----
S:={[1,4,16]};
SS:=S^N;
SS;
SSS:=Setseq(SS);
for i in [1..#SS] do
for g in IN do if ts[1]*ts[4]*ts[16] eq g
*ts[Rep(SSS[i])[1]]*ts[Rep(SSS[i])[2]]*ts[Rep(SSS[i])[3]]
then print SSS[i]; end if; end for; end for;
N1416:=Stabiliser(N,[1,4,16]);
#N1416;
for g in N do if 1^g eq 15 and 4^g eq 5 and 16^g eq 1 then
  N1416:=sub<N|N1416,g>; end if; end for;
for g in N do if 1^g eq 16 and 4^g eq 6 and 16^g eq 20 then
  N1416:=sub<N|N1416,g>; end if; end for;
for g in N do if 1^g eq 1 and 4^g eq 7 and 16^g eq 19 then
  N1416:=sub<N|N1416,g>; end if; end for;
for g in N do if 1^g eq 17 and 4^g eq 23 and 16^g eq 4 then
  N1416:=sub<N|N1416,g>; end if; end for;
for g in N do if 1^g eq 6 and 4^g eq 17 and 16^g eq 5 then
  N1416:=sub<N|N1416,g>; end if; end for;
for g in N do if 1^g eq 17 and 4^g eq 5 and 16^g eq 6 then
  N1416:=sub<N|N1416,g>; end if; end for;
for g in N do if 1^g eq 6 and 4^g eq 21 and 16^g eq 7 then
  N1416:=sub<N|N1416,g>; end if; end for;
for g in N do if 1^g eq 18 and 4^g eq 16 and 16^g eq 22 then
  N1416:=sub<N|N1416,g>; end if; end for;
for g in N do if 1^g eq 16 and 4^g eq 1 and 16^g eq 4 then
  N1416:=sub<N|N1416,g>; end if; end for;
for g in N do if 1^g eq 19 and 4^g eq 20 and 16^g eq 30 then
  N1416:=sub<N|N1416,g>; end if; end for;

```

```

for g in N do if 1g eq 20 and 4g eq 19 and 16g eq 30 then
  N1416:=sub<N/N1416,g>; end if; end for;
for g in N do if 1g eq 21 and 4g eq 4 and 16g eq 30 then
  N1416:=sub<N/N1416,g>; end if; end for;
for g in N do if 1g eq 22 and 4g eq 5 and 16g eq 30 then
  N1416:=sub<N/N1416,g>; end if; end for;
for g in N do if 1g eq 7 and 4g eq 6 and 16g eq 21 then
  N1416:=sub<N/N1416,g>; end if; end for;
for g in N do if 1g eq 23 and 4g eq 7 and 16g eq 22 then
  N1416:=sub<N/N1416,g>; end if; end for;
for g in N do if 1g eq 24 and 4g eq 10 and 16g eq 2 then
  N1416:=sub<N/N1416,g>; end if; end for;
for g in N do if 1g eq 25 and 4g eq 10 and 16g eq 3 then
  N1416:=sub<N/N1416,g>; end if; end for;
for g in N do if 1g eq 9 and 4g eq 11 and 16g eq 29 then
  N1416:=sub<N/N1416,g>; end if; end for;
for g in N do if 1g eq 26 and 4g eq 12 and 16g eq 28 then
  N1416:=sub<N/N1416,g>; end if; end for;
for g in N do if 1g eq 2 and 4g eq 13 and 16g eq 28 then
  N1416:=sub<N/N1416,g>; end if; end for;
for g in N do if 1g eq 3 and 4g eq 14 and 16g eq 13 then
  N1416:=sub<N/N1416,g>; end if; end for;
for g in N do if 1g eq 12 and 4g eq 14 and 16g eq 8 then
  N1416:=sub<N/N1416,g>; end if; end for;
for g in N do if 1g eq 11 and 4g eq 29 and 16g eq 9 then
  N1416:=sub<N/N1416,g>; end if; end for;
for g in N do if 1g eq 11 and 4g eq 12 and 16g eq 10 then
  N1416:=sub<N/N1416,g>; end if; end for;
for g in N do if 1g eq 12 and 4g eq 11 and 16g eq 10 then
  N1416:=sub<N/N1416,g>; end if; end for;
for g in N do if 1g eq 12 and 4g eq 10 and 16g eq 11 then
  N1416:=sub<N/N1416,g>; end if; end for;
for g in N do if 1g eq 11 and 4g eq 10 and 16g eq 12 then
  N1416:=sub<N/N1416,g>; end if; end for;
for g in N do if 1g eq 11 and 4g eq 27 and 16g eq 13 then
  N1416:=sub<N/N1416,g>; end if; end for;
for g in N do if 1g eq 12 and 4g eq 8 and 16g eq 14 then
  N1416:=sub<N/N1416,g>; end if; end for;
for g in N do if 1g eq 26 and 4g eq 9 and 16g eq 3 then
  N1416:=sub<N/N1416,g>; end if; end for;
for g in N do if 1g eq 27 and 4g eq 26 and 16g eq 24 then
  N1416:=sub<N/N1416,g>; end if; end for;
for g in N do if 1g eq 9 and 4g eq 2 and 16g eq 8 then
  N1416:=sub<N/N1416,g>; end if; end for;

```

```

for g in N do if 1^g eq 26 and 4^g eq 3 and 16^g eq 9 then
  N1416:=sub<N/N1416,g>; end if; end for;
for g in N do if 1^g eq 28 and 4^g eq 29 and 16^g eq 25 then
  N1416:=sub<N/N1416,g>; end if; end for;
for g in N do if 1^g eq 13 and 4^g eq 28 and 16^g eq 2 then
  N1416:=sub<N/N1416,g>; end if; end for;
for g in N do if 1^g eq 29 and 4^g eq 28 and 16^g eq 25 then
  N1416:=sub<N/N1416,g>; end if; end for;
for g in N do if 1^g eq 28 and 4^g eq 13 and 16^g eq 2 then
  N1416:=sub<N/N1416,g>; end if; end for;
for g in N do if 1^g eq 27 and 4^g eq 8 and 16^g eq 25 then
  N1416:=sub<N/N1416,g>; end if; end for;
for g in N do if 1^g eq 8 and 4^g eq 9 and 16^g eq 2 then
  N1416:=sub<N/N1416,g>; end if; end for;
for g in N do if 1^g eq 3 and 4^g eq 10 and 16^g eq 25 then
  N1416:=sub<N/N1416,g>; end if; end for;
for g in N do if 1^g eq 13 and 4^g eq 11 and 16^g eq 27 then
  N1416:=sub<N/N1416,g>; end if; end for;
for g in N do if 1^g eq 14 and 4^g eq 12 and 16^g eq 8 then
  N1416:=sub<N/N1416,g>; end if; end for;
for g in N do if 1^g eq 14 and 4^g eq 13 and 16^g eq 3 then
  N1416:=sub<N/N1416,g>; end if; end for;
for g in N do if 1^g eq 29 and 4^g eq 14 and 16^g eq 24 then
  N1416:=sub<N/N1416,g>; end if; end for;
for g in N do if 1^g eq 23 and 4^g eq 17 and 16^g eq 4 then
  N1416:=sub<N/N1416,g>; end if; end for;
for g in N do if 1^g eq 17 and 4^g eq 6 and 16^g eq 5 then
  N1416:=sub<N/N1416,g>; end if; end for;
for g in N do if 1^g eq 5 and 4^g eq 17 and 16^g eq 6 then
  N1416:=sub<N/N1416,g>; end if; end for;
for g in N do if 1^g eq 21 and 4^g eq 6 and 16^g eq 7 then
  N1416:=sub<N/N1416,g>; end if; end for;
for g in N do if 1^g eq 16 and 4^g eq 18 and 16^g eq 22 then
  N1416:=sub<N/N1416,g>; end if; end for;
for g in N do if 1^g eq 1 and 4^g eq 16 and 16^g eq 4 then
  N1416:=sub<N/N1416,g>; end if; end for;
for g in N do if 1^g eq 4 and 4^g eq 21 and 16^g eq 30 then
  N1416:=sub<N/N1416,g>; end if; end for;
for g in N do if 1^g eq 5 and 4^g eq 22 and 16^g eq 30 then
  N1416:=sub<N/N1416,g>; end if; end for;
for g in N do if 1^g eq 6 and 4^g eq 7 and 16^g eq 21 then
  N1416:=sub<N/N1416,g>; end if; end for;
for g in N do if 1^g eq 7 and 4^g eq 23 and 16^g eq 22 then
  N1416:=sub<N/N1416,g>; end if; end for;

```

```

for g in N do if 1^g eq 19 and 4^g eq 7 and 16^g eq 1 then
  N1416:=sub<N/N1416,g>; end if; end for;
for g in N do if 1^g eq 20 and 4^g eq 23 and 16^g eq 15 then
  N1416:=sub<N/N1416,g>; end if; end for;
for g in N do if 1^g eq 18 and 4^g eq 22 and 16^g eq 16 then
  N1416:=sub<N/N1416,g>; end if; end for;
for g in N do if 1^g eq 16 and 4^g eq 4 and 16^g eq 1 then
  N1416:=sub<N/N1416,g>; end if; end for;
for g in N do if 1^g eq 18 and 4^g eq 19 and 16^g eq 17 then
  N1416:=sub<N/N1416,g>; end if; end for;
for g in N do if 1^g eq 16 and 4^g eq 20 and 16^g eq 6 then
  N1416:=sub<N/N1416,g>; end if; end for;
:
:
for g in N do if 1^g eq 15 and 4^g eq 1 and 16^g eq 5 then
  N1416:=sub<N/N1416,g>; end if; end for;
for g in N do if 1^g eq 21 and 4^g eq 18 and 16^g eq 15 then
  N1416:=sub<N/N1416,g>; end if; end for;
[1,4,16]^N1416;
#N1416;
Orbits(N1416);
T1416:=Transversal(N,N1416);
for i in [1..#T1416] do
  ss=[1,4,16]^T1416[i];
  cst[prodim(1, ts, ss)] := ss;
end for;
m:=0;
for i in [1..1232] do if cst[i] ne [] then m:=m+1; end if;
end for; m;

```

## Appendix E

# MAGMA Code for DCE of $M_{22}$ Over $S_6$

```

S:=Sym(30);
xx:=S!(1, 2, 4, 8)(3, 6, 11, 18, 26, 20, 29, 22)
      (5, 10, 17, 12, 19, 28, 30, 25)(7,13, 21,
27, 15, 24, 23, 14)(9, 16);
yy:=S!(1, 3, 7, 14, 23, 29, 4, 9)(2, 5, 10, 6,
      12, 20, 28, 30)(8, 15, 25, 21)(11, 16, 26,
19, 13, 22, 24, 17)(18, 27);
N:=sub<S/xx,yy>;
G<x,y,t>:=Group<x,y,t/x^8,y^8,(x*y^-2*x)^2,(x^-1*y^-1)^4,
(x*y^-1)^4,(y^-1*x^-1*y*x^3*y*x^-1*y^-1*x),
(y*x*y*x^3*y*x*y^2),t^2,(t,x^4),(t,x*y*x^-1*y^-2*x),
(t,x*y*x*y*x^-1*y^-1),((x^-3)*t^(y^3))^5,((x^-3)*t^(y^7))^4
,x^2*t*x^-1*y*t*y^-1*x^-1*t>;
f,G1,k:=CosetAction(G,sub<G/x,y>);
#G1; #k;
CompositionFactors(G1);
Center(G1);
#DoubleCosets(G,sub<G/x,y>,sub<G/x,y>);
#sub<G/x,y>;
Sch:=SchreierSystem(G,sub<G/Id(G)>);
ArrayP:=[Id(N): i in [1..443520]];
for i in [2..443520] do
P:=[Id(N): l in [1..#Sch[i]]];
for j in [1..#Sch[i]] do
if Eltseq(Sch[i])[j] eq 1 then P[j]:=xx; end if;
if Eltseq(Sch[i])[j] eq -1 then P[j]:=xx^-1; end if;

```

```

if Eltseq(Sch[i])[j] eq 2 then P[j]:=yy; end if;
if Eltseq(Sch[i])[j] eq -2 then P[j]:=yy^-1; end if;
end for;
PP:=Id(N);
for k in [1..#P] do
PP:=PP*P[k]; end for;
ArrayP[i]:=PP;
end for;
Index(G, sub<G|x,y>);
ts:=[f(t), f(t^(x)), f(t^(y)), f(t^(x^2)), f(t^(x*y)), f(t^(y*x)),
f(t^(y^2)), f(t^(x^3)), f(t^(y^7)), f(t^(x*(y^2))), f(t^(y*(x^2)))
, f(t^(x*(y^4))), f(t^((y^2)*x)), f(t^(y^3)), f(t^((y^2)*(x^4))),
f(t^((y^7)*x)), f(t^(x*y*(x^2))), f(t^(y*(x^3))), f(t^(x*y*(x^4)))
, f(t^(y*(x^5))), f(t^((x^3)*(y^3))), f(t^(y*(x^7))), f(t^(y^4)),
f(t^((y^2)*(x^5))), f(t^((x^3)*(y^2))), f(t^(y*(x^4))),
f(t^((y^2)*(x^3))), f(t^(x*(y^6))), f(t^(y^5)), f(t^(x*(y^7)))]];
IN:=sub<G1|f(x),f(y)>;
prodim := function(pt, Q, I)
/*
Return the image of pt under permutations Q[I] applied sequentially.
*/
v := pt;
for i in I do
v := v^(Q[i]);
end for;
return v;
end function;

cst := [null : i in [1 ..616]] where null is [Integers() | ];
for i := 1 to 30 do
cst[prodim(1, ts, [i])] := [i];
end for;
m:=0;
for i in [1..616] do if cst[i] ne [] then m:=m+1; end if; end for; m;
N1:=Stabiliser(N,1);
Orbits(N1);
#N1;
-----
S:={[1,2]};
SS:=S^N;
SS;
SSS:=Setseq(SS);
for i in [1..#SS] do
for g in IN do if ts[1]*ts[2] eq g*ts[Rep(SSS[i])[1]]*

```

```

ts[Rep(SSS[i])[2]] then print SSS[i]; end if; end for;
end for;
N12:=Stabiliser(N,[1,2]);
#N12;
Orbits(N12);
#SSS;
T12:=Transversal(N,N12);
for i in [1..#T12] do
ss=[1,2]^T12[i];
cst[prodim(1, ts, ss)] := ss;
end for;
m:=0;
for i in [1..616] do if cst[i] ne [] then m:=m+1; end if; end for; m;
-----
S:={[1,3]};
SS=S^N;
SS;
SSS:=Setseq(SS);
for i in [1..#SS] do
for g in IN do if ts[1]*ts[3] eq g*ts[Rep(SSS[i])[1]]
*ts[Rep(SSS[i])[2]] then print SSS[i]; end if; end for;
end for;
N13:=Stabiliser(N,[1,3]);
#N13;
for g in N do if 1^g eq 3 and 3^g eq 1 then
N13:=sub<N|N13,g>; end if; end for;
[1,3]^N13;
#N13;
Orbits(N13);
T13:=Transversal(N,N13);
for i in [1..#T13] do
ss=[1,3]^T13[i];
cst[prodim(1, ts, ss)] := ss;
end for;
m:=0;
for i in [1..616] do if cst[i] ne [] then m:=m+1; end if;
end for; m;
-----
S:={[1,2,4]};
SS=S^N;
SS;
SSS:=Setseq(SS);
for i in [1..#SS] do
for g in IN do if ts[1]*ts[2]*ts[4] eq g*ts[Rep(SSS[i])[1]]

```



```

*ts[Rep(SSS[i])[2]]*ts[Rep(SSS[i])[3]] then print SSS[i];
end if; end for; end for;
N124:=Stabiliser(N,[1,2,4]);
#N124;
for g in N do if 1^g eq 2 and 2^g eq 1 and 4^g eq 8 then
  N124:=sub<N|N124,g>; end if; end for;
[1,2,4]^N124;
#N124;
Orbits(N124);
T124:=Transversal(N,N124);
for i in [1..#T124] do
  ss=[1,2,4]^T124[i];
  cst[prodim(1, ts, ss)] := ss;
end for;
m:=0;
for i in [1..616] do if cst[i] ne [] then m:=m+1; end if;
end for; m;

```

## Appendix F

# MAGMA Code for The Progenitor $2^{*8} : (2^3 : 2^2)$

```

/* to find the parmatation */
NumberOfTransitiveGroups(8);
N:=TransitiveGroup(8,22);
D:=SmallGroupDatabase ();
G:=SmallGroup(D,IdentifyGroup(N)[1],IdentifyGroup(N)[2]);
f,G1,k:=CosetAction(G,sub<G/Id(G)>);
SL:=Subgroups(G1);
T:= {X'subgroup: X in SL};
TrivCore:={H:H in T| #Core(G1,H) eq 1};
mdeg:=Min({Index(G1,H):H in TrivCore});
Good:={H: H in TrivCore| Index(G1,H) eq mdeg};
H:=Rep(Good);
f,G1,K := CosetAction(G1,H);
G1;
FPGroup(G);

G<a,b,c,d,e>:=Group<a,b,c,d,e/a^2,b^2,c^2,d^2,e^2,b^a=b*e,
c^a=c,c^b=c*e,d^a=d*e,d^b=d,d^c=d,e^a=e,e^b=e,e^c=e,e^d=e>;
#G;
/* Write a presentation for the progenitor 2*8: N */

S:=Sym(8);
aa:=S! (2, 5)(6, 7);
bb:=S! (1, 2)(3, 7)(4, 5)(6, 8);
cc:=S! (1, 3)(2, 6)(4, 8)(5, 7);
dd:=S! (1, 2)(3, 6)(4, 5)(7, 8);

```

```

ee:=S! (1, 4)(2, 5)(3, 8)(6, 7);
N:=sub<S/aa,bb,cc,dd,ee>;
G<a,b,c,d,e>:=Group<a,b,c,d,e/a^2,b^2,c^2,d^2,e^2,b^a=b*e,
c^a=c,c^b=c*e,d^a=d*e,d^b=d,d^c=d,e^a=e,e^b=e,e^c=e,e^d=e>;
#G;
Sch:=SchreierSystem(G,sub<G/Id(G)>);
ArrayP:=[Id(N): i in [1..32]];
for i in [2..32] do
P:=[Id(N): l in [1..#Sch[i]]];
for j in [1..#Sch[i]] do
if Eltseq(Sch[i])[j] eq 1 then P[j]:=aa; end if;
if Eltseq(Sch[i])[j] eq 2 then P[j]:=bb; end if;
if Eltseq(Sch[i])[j] eq 3 then P[j]:=cc; end if;
if Eltseq(Sch[i])[j] eq 4 then P[j]:=dd; end if;
if Eltseq(Sch[i])[j] eq 5 then P[j]:=ee; end if;
end for;
PP:=Id(N);
for k in [1..#P] do
PP:=PP*P[k]; end for;
ArrayP[i]:=PP;
end for;
for i in [1..32] do Sch[i], ArrayP[i]; end for;
N1:=Stabiliser(N,1);
N1;
N12:=Stabiliser(N,{1,2});
N12;
C:=Centraliser(N,N12);
C;

G<a,b,c,d,e,t>:=Group<a,b,c,d,e,t/a^2,b^2,c^2,d^2,e^2,b^a=b*e,
c^a=c,c^b=c*e,d^a=d*e,d^b=d,d^c=d,e^a=e,e^b=e,e^c=e,e^d=e,t^2,
(t,a),(t,b*d)>;
#G;
/*To find the first order relations and add them to the
presentation to find the Homomorphic Images*/
C:=Classes(N);
C;

C2:=Centraliser(N,N!(1, 4)(2, 5)(3, 8)(6, 7));
C3:=Centraliser(N,N!(1, 2)(3, 7)(4, 5)(6, 8));
C4:=Centraliser(N,N!(1, 3)(2, 6)(4, 8)(5, 7));
C5:=Centraliser(N,N!(2, 5)(6, 7));
C6:=Centraliser(N,N!(1, 3)(2, 7)(4, 8)(5, 6));
C7:=Centraliser(N,N!(1, 6)(2, 8)(3, 5)(4, 7));

```

```

C8:=Centraliser(N,N!(3, 8)(6, 7));
C9:=Centraliser(N,N!(1, 2)(3, 6)(4, 5)(7, 8));
C10:=Centraliser(N,N!(1, 6)(2, 3)(4, 7)(5, 8));
C11:=Centraliser(N,N!(2, 5)(3, 8));
C12:=Centraliser(N,N!(1, 5, 4, 2)(3, 6, 8, 7));
C13:=Centraliser(N,N!(1, 6, 4, 7)(2, 3, 5, 8));
C14:=Centraliser(N,N!(1, 3, 4, 8)(2, 6, 5, 7));
C15:=Centraliser(N,N!(1, 5, 4, 2)(3, 7, 8, 6));
C16:=Centraliser(N,N!(1, 3, 4, 8)(2, 7, 5, 6));
C17:=Centraliser(N,N!(1, 6, 4, 7)(2, 8, 5, 3));

Set(C2); Orbits(C2);
Set(C3); Orbits(C3);
Set(C4); Orbits(C4);
Set(C5); Orbits(C5);
Set(C6); Orbits(C6);
Set(C7); Orbits(C7);
Set(C8); Orbits(C8);
Set(C9); Orbits(C9);
Set(C10); Orbits(C10);
Set(C11); Orbits(C11);
Set(C12); Orbits(C12);
Set(C13); Orbits(C13);
Set(C14); Orbits(C14);
Set(C15); Orbits(C15);
Set(C16); Orbits(C16);
Set(C17); Orbits(C17);

/*
t ~ t_1
Class[2]
(Orbits (C2)= GSet{@ 1, 2, 3, 4, 5, 6, 7, 8 @}
(e*t)^w

Class[3]
(Orbits of C3 ) = GSet{@ 1, 2, 5, 3, 4, 7, 6, 8 @}
(b*t)^f

Class[4]
(Orbits of C4 ) = GSet{@ 1, 3, 8, 2, 4, 6, 7, 5 @}
(c*t)^j

Class[5]
(Orbits of C5) = GSet{@ 1, 4, 8, 3 @}, GSet{@ 2, 5, 6, 7 @}

```

$(a*t)^n, (a*t^b)^o$

*Class[6]*

(Orbits of  $C_6$ ) =  $GSet\{0, 1, 3, 8, 2, 4, 7, 6, 5\}$   
 $(a*c*t)^s$

*Class[7]*

(Orbits of  $C_7$ ) =  $GSet\{0, 1, 6, 7, 2, 4, 8, 3, 5\}$   
 $(a*b*c*t)^k$

*Class[8]*

(Orbits of  $C_8$ ) =  $GSet\{0, 1\}, GSet\{0, 2, 3, 4, 8, 5, 7, 9, 6\}$   
 $(b*d*t)^l, (b*d*t^b)^p$

*Class[9]*

(Orbits of  $C_9$ ) =  $\{0, 1, 2, 5, 3, 4, 6, 7, 8\}$   
 $(d*t)^y$

*Class[10]*

(Orbits  $C_{10}$ ) =  $GSet\{0, 1, 6, 7, 2, 4, 3, 8, 5\}$   
 $(c*d*t)^z$

*Class[11]*

(Orbits of  $C_{11}$ ) =  $GSet\{0, 1, 4, 7, 6\}, GSet\{0, 2, 5, 3, 8\}$   
 $(a*b*d*t)^v$   
 $(a*b*d*t^b)^y$

*Class[12]*

(Orbits of  $C_{12}$ ) =  $GSet\{0, 1, 5, 3, 4, 6, 8, 2, 7\}$   
 $(a*b*e*t)^j$

*Class[13]*

(Orbits of  $C_{13}$ ) =  $GSet\{0, 1, 6, 2, 4, 3, 5, 7, 8\}$   
 $(b*c*t)^n$

*Class[14]*

(Orbits of  $C_{14}$ ) =  $GSet\{0, 1, 3, 2, 4, 6, 5, 8, 7\}$   
 $(b*c*d*t)^o$

*Class[15]*

(Orbits of  $C_{15}$ ) =  $GSet\{0, 1, 5, 3, 4, 7, 8, 2, 6\}$   
 $(a*d*e*t)^k$

*Class[16]*

```

(Orbits of C16 ) = GSet{@ 1, 3, 2, 4, 7, 5, 8, 6 @}
(a*b*c*d*t)^l

Class[17]
(Orbits of C17 ) = GSet{@ 1, 6, 2, 4, 8, 5, 7, 3 @}
(a*c*d*t)^s
*/
for f,j,h,i,l,S,n,o,p,q,x,y,z,v,s,g,I,u,r in [0..10] do
G<a,b,c,d,e,t>:=Group<a,b,c,d,e,t/a^2,b^2,c^2,d^2,e^2,b^a=b*e,
c^a=c,c^b=c*e,d^a=d*e,d^b=d,d^c=d,e^a=e,e^b=e,e^c=e,e^d=e,t^2,
(t,a),(t,b*d),(e*t)^f,(b*t)^j,(c*t)^h,(a*t)^i,(a*t^b)^l,(a*c*t)^S,
(a*b*c*t)^n,(b*d*t)^o,(b*d*t^b)^p,(d*t)^q,(c*d*t)^x,(a*b*d*t)^y,
(a*b*d*t^b)^z,(a*b*e*t)^v,(b*c*t)^s,(b*c*d*t)^g,(a*d*e*t)^I,
(a*b*c*d*t)^u,(a*c*d*t)^r>;
if #G gt 32 then f,j,h,i,l,S,n,o,p,q,x,y,z,v,s,g,I,u,r,
Index(G,sub<G/a,b,c,d,e>), #G; end if; end for;

/* Relations by use the lemma: */
N12:=Stabiliser(N,{1,2});
N12;
b * d = (3, 8)(6, 7) => (t*t^b)^k=b * d
b (1, 2)(3, 7)(4, 5)(6, 8) => (b*t)^m=1

```

## Appendix G

# MAGMA Code for The Progenitor $2^{*9} : (3^2 : 2^4)$

```

/*Find the permutations to write the progenitor*/
N:=TransitiveGroup(9,19);
D:=SmallGroupDatabase ();
G:=SmallGroup(D,IdentifyGroup(N)[1],IdentifyGroup(N)[2]);
f,G1,k:=CosetAction(G,sub<G/Id(G)>);
SL:=Subgroups(G1);
T:= {X'subgroup: X in SL};
TrivCore:={H:H in T| #Core(G1,H) eq 1};
mdeg:=Min({Index(G1,H):H in TrivCore});
Good:={H: H in TrivCore| Index(G1,H) eq mdeg};
H:=Rep(Good);
f,G1,K := CosetAction(G1,H);
G1;
FPGGroup(G);
G<a,b,c,d,e,f>:=Group<a,b,c,d,e,f|a^8,b^2,c^4,d^2,
e^3,f^3,(e,f),a^2=c,c^2=d,b^a=b*c*d,c^a=c,c^b=c*d,
d^a=d,d^b=d,d^c=d,e^a=f,e^b=e*(f^2),e^c=e*(f^2),
e^d=e^2,f^a=e*(f^2),f^b=f^2,f^c=(e^2)*(f^2),f^d=f^2,
f^e=f>;
#G;
S:=Sym(9);
aa:=S!(2, 3, 4, 8, 5, 7, 9, 6);
bb:=S!(2, 4)(3, 7)(5, 9);
cc:=S!(2, 4, 5, 9)(3, 8, 7, 6);
dd:=S!(2, 5)(3, 7)(4, 9)(6, 8);
ee:=S!(1, 2, 5)(3, 6, 9)(4, 8, 7);

```

```

ff:=S!(1, 3, 7)(2, 6, 4)(5, 9, 8);
N:=sub<S/aa,bb,cc,dd,ee,ff>;
/*Write the progenitor 2^9 :N */
G<a,b,c,d,e,f>:=Group<a,b,c,d,e,f/a^8,b^2,c^4,d^2,e^3,
f^3,(e,f),a^2=c,c^2=d,b^a=b*c*d,c^a=c,c^b=c*d,d^a=d,
d^b=d,d^c=d,e^a=f,e^b=e*(f^2),e^c=e*(f^2),e^d=e^2,
f^a=e*(f^2),f^b=f^2,f^c=(e^2)*(f^2),f^d=f^2,f^e=f>;

/*Write the presentation of the progenitor 2^9 :N */
Sch:=SchreierSystem(G,sub<G/Id(G)>);
ArrayP:=[Id(N): i in [1..144]];
for i in [2..144] do
P:=[Id(N): l in [1..#Sch[i]]];
for j in [1..#Sch[i]] do
if Eltseq(Sch[i])[j] eq 1 then P[j]:=aa; end if;
if Eltseq(Sch[i])[j] eq -1 then P[j]:=aa^-1; end if;
if Eltseq(Sch[i])[j] eq 2 then P[j]:=bb; end if;
if Eltseq(Sch[i])[j] eq 3 then P[j]:=cc; end if;
if Eltseq(Sch[i])[j] eq -3 then P[j]:=cc^-1; end if;
if Eltseq(Sch[i])[j] eq 4 then P[j]:=dd; end if;
if Eltseq(Sch[i])[j] eq 5 then P[j]:=ee; end if;
if Eltseq(Sch[i])[j] eq -5 then P[j]:=ee^-1; end if;
if Eltseq(Sch[i])[j] eq 6 then P[j]:=ff; end if;
if Eltseq(Sch[i])[j] eq -6 then P[j]:=ff^-1; end if;
end for;
PP:=Id(N);
for k in [1..#P] do
PP:=PP*P[k]; end for;
ArrayP[i]:=PP;
end for;
for i in [1..144] do Sch[i], ArrayP[i]; end for;
N1:=Stabiliser(N,1);
N1;
G<a,b,c,d,e,f,t>:=Group<a,b,c,d,e,f,t/a^8,b^2,c^4,
d^2,e^3,f^3,(e,f),a^2=c,c^2=d,b^a=b*c*d,c^a=c,c^b=c*d,
d^a=d,d^b=d,d^c=d,e^a=f,e^b=e*(f^2),e^c=e*(f^2),
e^d=e^2,f^a=e*(f^2),f^b=f^2,f^c=(e^2)*(f^2),f^d=f^2,
f^e=f,t^2,(t,a),(t,b),(t,c),(t,d)>;
#G;

/*Find the first order relation and the lemma's relations
to add them in our presentation.*/

C:=Classes(N);

```



```

C;
C2:=Centraliser(N,N!(1, 6)(2, 3)(4, 7)(5, 9));
C3:=Centraliser(N,N!(1, 3)(4, 6)(5, 8));
C4:=Centraliser(N,N!(1, 2, 5)(3, 6, 9)(4, 8, 7));
C5:=Centraliser(N,N!(1, 9, 6, 5)(2, 4, 3, 7));
C6:=Centraliser(N,N!(1, 4, 3, 8)(2, 6, 9, 5));
C7:=Centraliser(N,N!(1, 4, 8, 3, 6, 5)(2, 9, 7));
C8:=Centraliser(N,N!(2, 3, 4, 8, 5, 7, 9, 6));
C9:=Centraliser(N,N!(2, 7, 4, 6, 5, 3, 9, 8));
Set(C2); Orbits(C2);
Set(C3); Orbits(C3);
Set(C4); Orbits(C4);
Set(C5); Orbits(C5);
Set(C6); Orbits(C6);
Set(C7); Orbits(C7);
Set(C8); Orbits(C8);
Set(C9); Orbits(C9);

/*
t ~ t_1
for i in [1..144] do
for> if ArrayP[i] eq N!(2, 7, 4, 6, 5, 3, 9, 8) then Sch[i];
end if; end for;
Orbits(C2)= GSet{@ 8 @}, GSet{@ 1, 6, 5, 3, 9, 2, 4, 7 @}
(c * f^-1 * c*t)^E
(c * f^-1 * c*t^(f*c))^w
Orbits(C3)= GSet{@ 2, 9, 7 @}, GSet{@ 1, 3, 4, 6, 5, 8 @}
(b * f*t)^f
(b * f*t^e)^q
Orbits(C4)= GSet{@ 1, 2, 3, 5, 6, 8, 9, 7, 4 @}
(e*t)^j
Orbits(C5)= GSet{@ 8 @}, GSet{@ 1, 9, 2, 6, 4, 5, 3, 7 @}
(e * c^-1*t)^n
(e * c^-1*t^(f*c))^o
Orbits(C6)= GSet{@ 7 @},GSet{@ 1, 4, 3, 8 @},GSet{@ 2, 6, 9, 5 @}
(a * e * b*t)^r
(a * e * b*t^(f^-1))^u
(a * e * b*t^e)^i
Orbits(C7)= GSet{@ 2, 9, 7 @}, GSet{@ 1, 3, 4, 6, 8, 5 @}
(e * b*t)^y
(e * b*t^e)^h
Orbits(C8)= GSet{@ 1 @}, GSet{@ 2, 3, 4, 8, 5, 7, 9, 6 @}
(a*t)^l
(a*t^e)^s

```

```

Orbits(C9)= GSet{@ 1 @}, GSet{@ 2, 7, 4, 6, 5, 3, 9, 8 @}
(a * d*t)^x
(a * d*t^e)^z
*/
for E,w,F,q,j,n,o,r,u,i,y,h,l,s,x,z in [0..10] do
G<a,b,c,d,e,f,t>:=Group<a,b,c,d,e,f,t/a^8,b^2,c^4,d^2,e^3,
f^3,(e,f),a^2=c,c^2=d,b^a=b*c*d,c^a=c,c^b=c*d,d^a=d,
d^b=d,d^c=d,e^a=f,e^b=e*(f^2),e^c=e*(f^2),e^d=e^2,
f^a=e*(f^2),f^b=f^2,f^c=(e^2)*(f^2),f^d=f^2,f^e=f,
t^2,(t,a),(t,b),(t,c),(t,d),(c*f^-1*c*t)^E,
(c*f^-1*c*t^(f*c))^w,(b*f*t)^F,(b*f*t^e)^q,(e*t)^j,
(e*c^-1*t)^n,(e*c^-1*t^(f*c))^o,(a*e*b*t)^r,
(a*e*b*t^(f^-1))^u,(a*e*b*t^e)^i,(e*b*t)^y,(e*b*t^e)^h,
(a*t)^l,(a*t^e)^s,(a*d*t)^x,(a*d*t^e)^z>;
if #G gt 144 then E,w,F,q,j,n,o,r,u,i,y,h,l,s,x,z,
Index(G,sub<G/a,b,c,d,e,f>), #G; end if; end for;

/*
Find relation by using the lemma,
N12:=Stabiliser(N,{1,2});
N12;
b * c^-1 = (3, 8)(4, 9)(6, 7)
b * c * e = (1, 2)(3, 9)(4, 8)
the first realation will be (t*t^f)^k=b * c^-1
the second relation will be (b * c * e*t)^m=1
*/

for z,k,m in [0..10] do
G<a,b,c,d,e,f,t>:=Group<a,b,c,d,e,f,t/a^8,b^2,c^4,d^2,
e^3,f^3,(e,f),a^2=c,c^2=d,b^a=b*c*d,c^a=c,c^b=c*d,d^a=d,
d^b=d,d^c=d,e^a=f,e^b=e*(f^2),e^c=e*(f^2),e^d=e^2,
f^a=e*(f^2),f^b=f^2,f^c=(e^2)*(f^2),f^d=f^2,f^e=f,t^2,
(t,a),(t,b),(t,c),(t,d),(a*d*t^e)^z,(t*t^f)^k=b*c^-1,
(b*c*e*t)^m=1>;
if #G gt 144 then z,k,m, Index(G,sub<G/a,b,c,d,e,f>),
#G; end if; end for;

```

## Appendix H

# MAGMA Code for The Progenitor $2^{*10} : (2^4 : (2 \times 5))$

```

N:=TransitiveGroup(10,16);
D:=SmallGroupDatabase ();
G:=SmallGroup(D,IdentifyGroup(N)[1],IdentifyGroup(N)[2]);
f,G1,k:=CosetAction(G,sub<G/Id(G)>);
SL:=Subgroups(G1);
T:= {X'subgroup: X in SL};
TrivCore:={H:H in T| #Core(G1,H) eq 1};
mdeg:=Min({Index(G1,H):H in TrivCore});
Good:={H: H in TrivCore| Index(G1,H) eq mdeg};
H:=Rep(Good);
f,G1,K := CosetAction(G1,H);
G1;
FPGroup(G);

G<a,b,c,d,e,n>:=Group<a,b,c,d,e,n/a^2,b^5,c^2,d^2,e^2,n^2,
b^a=b^4,c^a=c*d,c^b=c*d,d^a=d,d^b=d*e,d^c=d,e^a=c*d*n,
e^b=e*n,e^c=e,e^d=e,n^a=c*e,n^b=c,n^c=n,n^d=n,n^e=n>;
#G;

S:=Sym(10);
aa:=S! (1, 2)(3, 5)(4, 7)(6, 9)(8, 10);
bb:=S! (1, 3, 6, 10, 7)(2, 4, 8, 9, 5);
cc:=S! (1, 2)(5, 7);
dd:=S! (3, 4)(5, 7);
ee:=S! (1, 2)(3, 4)(5, 7)(6, 8);
nn:=S! (5, 7)(9, 10);

```

```

N:=sub<S/aa,bb,cc,dd,nn>;
#N;
/*Find the presentation of the progenitor 2(*10) : N*/
Sch:=SchreierSystem(G,sub<G/Id(G)>);
ArrayP:=Id(N): i in [1..160];
for i in [2..160] do
P:=Id(N): l in [1..#Sch[i]];
for j in [1..#Sch[i]] do
if Eltseq(Sch[i])[j] eq 1 then P[j]:=aa; end if;
if Eltseq(Sch[i])[j] eq 2 then P[j]:=bb; end if;
if Eltseq(Sch[i])[j] eq -2 then P[j]:=bb-1; end if;
if Eltseq(Sch[i])[j] eq 3 then P[j]:=cc; end if;
if Eltseq(Sch[i])[j] eq 4 then P[j]:=dd; end if;
if Eltseq(Sch[i])[j] eq 5 then P[j]:=ee; end if;
if Eltseq(Sch[i])[j] eq 6 then P[j]:=nn; end if;
end for;
PP:=Id(N);
for k in [1..#P] do
PP:=PP*P[k]; end for;
ArrayP[i]:=PP;
end for;
N1:=Stabiliser(N,1);
N1;
G<a,b,c,d,e,n,t>:=Group<a,b,c,d,e,n,t/a2,b5,c2,d2,e2,n2,
b4a=b4,c4a=c*d,c4b=c*d,d4a=d,d4b=d*e,d4c=d,e4a=c*d*n,
e4b=e*n,e4c=e,e4d=e,n4a=c*e,n4b=c,n4c=n,n4d=n,n4e=n,t2,
(t,d),(t,n),(t,(a*c*n))>;
#G;

```

## Appendix I

# MAGMA Code for The Progenitor $2^{*18} : (2.(3^2 : 2))$

Write a progenitor for a transitive group on 18 points.

```

NumberOfTransitiveGroups(18);
983

N:=TransitiveGroup(18,12);
D:=SmallGroupDatabase ();
G:=SmallGroup(D,IdentifyGroup(N)[1],IdentifyGroup(N)[2]);
f,G1,k:=CosetAction(G,sub<G/Id(G)>);
SL:=Subgroups(G1);
T:= {X'subgroup: X in SL};
TrivCore:={H:H in T| #Core(G1,H) eq 1};
mdeg:=Min({Index(G1,H):H in TrivCore});
Good:={H: H in TrivCore| Index(G1,H) eq mdeg};
H:=Rep(Good);
f,G1,K := CosetAction(G1,H);
G1;
FPGGroup(G);
G<a,b,c,d>:=Group<a,b,c,d/a^2,b^2,c^3,d^3,b^a=b,c^a=c^2,
c^b=c,d^a=d^2,d^b=d,d^c=d>;
#G;
/* Write a presentation for the progenitor 2*18: N */

S:=Sym(18);
aa:=S!(3,7)(4,9)(5,10)(6,12)(8,14)(11,17)(13,15)
(16,18);

```

```

bb:=S! (1, 2)(3, 5)(4, 6)(7, 10)(8, 11)(9, 12)(13, 16)
      (14, 17)(15, 18);
cc:=S! (1, 3, 7)(2, 5, 10)(4, 8, 13)(6, 11, 16)(9, 15, 14)
      (12, 18, 17);
dd:=S! (1, 4, 9)(2, 6, 12)(3, 8, 15)(5, 11, 18)(7, 13, 14)
      (10, 16, 17);
N:=sub<S/aa,bb,cc,dd>;
G<a,b,c,d>:=Group<a,b,c,d/a^2,b^2,c^3,d^3,b^a=b,c^a=c^2,
c^b=c,d^a=d^2,d^b=d,d^c=d>;
#G;
Sch:=SchreierSystem(G,sub<G/Id(G)>);
ArrayP:=[Id(N): i in [1..36]];
for i in [2..36] do
P:=[Id(N): l in [1..#Sch[i]]];
for j in [1..#Sch[i]] do
if Eltseq(Sch[i])[j] eq 1 then P[j]:=aa; end if;
if Eltseq(Sch[i])[j] eq 2 then P[j]:=bb; end if;
if Eltseq(Sch[i])[j] eq 3 then P[j]:=cc; end if;
if Eltseq(Sch[i])[j] eq -3 then P[j]:=cc^-1; end if;
if Eltseq(Sch[i])[j] eq 4 then P[j]:=dd; end if;
if Eltseq(Sch[i])[j] eq -4 then P[j]:=dd^-1; end if;
end for;
PP:=Id(N);
for k in [1..#P] do
PP:=PP*P[k]; end for;
ArrayP[i]:=PP;
end for;
for i in [1..36] do Sch[i], ArrayP[i]; end for;
N1:=Stabiliser(N,1);
N1;
N12:=Stabiliser(N,{1,2});
N12;
C:=Centraliser(N,N12);
C;
G<a,b,c,d,t>:=Group<a,b,c,d,t/a^2,b^2,c^3,d^3,b^a=b,
c^a=c^2,c^b=c,d^a=d^2,d^b=d,d^c=d,t^2,(t,a)>;
#G;

/* To find the First order relations */
C:=Classes(N);
C;
C2:=Centraliser(N,N!(1, 2)(3, 5)(4, 6)(7, 10)(8, 11)
      (9, 12)(13, 16)(14, 17)(15, 18));
C3:=Centraliser(N,N!(3, 7)(4, 9)(5, 10)(6, 12)(8, 14)

```

```

(11, 17)(13, 15)(16, 18));
C4:=Centraliser(N,N!(1, 2)(3, 10)(4, 12)(5, 7)(6, 9)
(8, 17)(11, 14)(13, 18)(15, 16));
C5:=Centraliser(N,N!(1, 3, 7)(2, 5, 10)(4, 8, 13)
(6, 11, 16)(9, 15, 14)(12, 18, 17));
C6:=Centraliser(N,N!(1, 4, 9)(2, 6, 12)(3, 8, 15)
(5, 11, 18)(7, 13, 14)(10, 16, 17));
C7:=Centraliser(N,N!(1, 8, 14)(2, 11, 17)(3, 13, 9)
(4, 15, 7)(5, 16, 12)(6, 18, 10));
C8:=Centraliser(N,N!(1, 15, 13)(2, 18, 16)(3, 14, 4)
(5, 17, 6)(7, 9, 8)(10, 12, 11));
C9:=Centraliser(N,N!(1, 5, 7, 2, 3, 10)(4, 11, 13,
6, 8, 16)(9, 18, 14, 12, 15, 17));
C10:=Centraliser(N,N!(1, 6, 9, 2, 4, 12)(3, 11, 15,
5, 8, 18)(7, 16, 14, 10, 13, 17));
C11:=Centraliser(N,N!(1, 11, 14, 2, 8, 17)(3, 16, 9,
5, 13, 12)(4, 18, 7, 6, 15, 10));
C12:=Centraliser(N,N!(1, 18, 13, 2, 15, 16)(3, 17, 4,
5, 14, 6)(7, 12, 8, 10, 9, 11));

Set(C2); Orbits(C2);
Set(C3); Orbits(C3);
Set(C4); Orbits(C4);
Set(C5); Orbits(C5);
Set(C6); Orbits(C6);
Set(C7); Orbits(C7);
Set(C8); Orbits(C8);
Set(C9); Orbits(C9);
Set(C10); Orbits(C10);
Set(C11); Orbits(C11);
Set(C12); Orbits(C12);

/*
t ~ t_1
Class[2]
(Orbits of C2)= GSet{@ 1, 2, 3, 4, 5, 6, 7, 8, 9, 10, 11,
12, 13, 14, 15, 16, 17, 18 @}
(b*t)^e
Class[3]
(Orbits of C3 ) = GSet{@ 1, 2 @},GSet{@ 3, 7, 10, 5 @},
GSet{@ 4, 9, 12, 6 @},GSet{@ 8, 14, 17, 11 @},GSet{@ 13,
15, 18, 16 @}
(a*t)^f,(a*t^c)^g,(a*t^d)^h,(a*t^(c*d))^i,(a*t^(d*c^-1))^j
Class[4]

```

```

(Orbits of C4 ) = GSet{@ 1, 2 @},GSet{@ 3, 7, 10, 5 @},
GSet{@ 4, 9, 12, 6 @},GSet{@ 8, 14, 17, 11 @},GSet{@ 13,
  15, 18, 16 @}
(a*b*t)^l,(a*b*t^c)^n,(a*b*t^d)^o,(a*b*t^(c*d))^p,
(a*b*t^(d*c^-1))^q
Class[5]
(Orbits of C5) = GSet{@ 1, 3, 18, 7, 17, 13, 12, 4, 2,
  8, 5, 15, 10, 14, 16, 9, 6, 11 @}
(c*t)^r
Class[6]
(Orbits of C6 ) = GSet{@ 1, 4, 18, 9, 5, 13, 11, 14,
  2, 7, 6, 15, 12, 3, 16, 8, 17, 10 @}
(d*t)^s
Class[7]
(Orbits of C7 ) = GSet{@ 1, 8, 18, 14, 10, 13, 6, 9,
  2, 3, 11, 15, 17, 7, 16, 4, 12, 5 @}
(c*d*t)^w
Class[8]
(Orbits of C8 ) = GSet{@ 1, 15, 18, 17, 13, 16, 6, 4,
  8, 2, 5, 3, 7, 10, 14, 9, 12, 11 @}
(c*d^-1*t)^x
Class[9]
(Orbits of C9 ) = GSet{@ 1, 5, 18, 7, 14, 13, 2, 12,
  6, 3, 15, 8, 10, 17, 16, 9, 4, 11 @}
(b*c*t)^y
Class[10]
(Orbits of C10)= GSet{@ 1, 6, 18, 9, 3, 13, 2, 11, 17
  , 4, 15, 7, 12, 5, 16, 8, 14, 10 @}
(b*d*t)^z
Class[11]
(Orbits of C11 ) = GSet{@ 1, 11, 18, 14, 7, 13, 2, 6,
  12, 8, 15, 3, 17, 10, 16, 4, 9, 5 @}
(b*c*d*t)^v
Class[12]
(Orbits of C12 ) = GSet{@ 1, 18, 17, 13, 4, 8, 2, 5,
  10, 15, 14, 9, 16, 6, 11, 3, 7, 12 @}
(b*c*d^-1*t)^u
*/

for e,f,g,h,i,j,l,n,o,p,q,r,s,w,x,y,z,v,u in [0..10] do
G<a,b,c,d,t>:=Group<a,b,c,d,t/a^2,b^2,c^3,d^3,b^a=b,c^a=c^2,
c^b=c,d^a=d^2,d^b=d,d^c=d,t^2,(t,a),(b*t)^e,(a*t)^f,(a*t^c)^g,
(a*t^d)^h,(a*t^(c*d))^i,(a*t^(d*c^-1))^j,(a*b*t)^l,(a*b*t^c)^n,
(a*b*t^d)^o,(a*b*t^(c*d))^p,(a*b*t^(d*c^-1))^q,(c*t)^r,(d*t)^s,

```



```

(c*d*t)^w, ((c*d^-1)*t)^x, (b*c*t)^y, (b*d*t)^z, (b*c*d*t)^v,
((b*c*d^-1)*t)^u>;
if #G gt 36 then e,f,g,h,i,j,l,n,o,p,q,r,s,w,x,y,z,v,u,
  Index(G,sub<G/a,b,c,d>), #G; end if; end for;

* By use the lemma: */
N12:=Stabiliser(N,{1,2});
N12;
/*
a => (t*t^b)^k=a
b => (b*t)^m=1
*/
for k,e,f in [0..10] do
G<a,b,c,d,t>:=Group<a,b,c,d,t/a^2,b^2,c^3,d^3,b^a=b,c^a=c^2,c^b=c,
d^a=d^2,d^b=d,d^c=d,t^2,(t,a),(t*t^b)^k=a,(a*c*t*t^c)^e,
(c^2*d*t*t^d)^f>;
k,e,f#G; end for;

```

## Appendix J

# MAGMA Code for Monomial Progenitor $5^{*4} :_m (2^3 : 2^2)$

```

S:=Sym(8);
aa:=S! (2, 5)(6, 7);
bb:=S! (1, 2)(3, 7)(4, 5)(6, 8);
cc:=S! (1, 3)(2, 6)(4, 8)(5, 7);
dd:=S! (1, 2)(3, 6)(4, 5)(7, 8);
ee:=S! (1, 4)(2, 5)(3, 8)(6, 7);
N:=sub<S|aa,bb,cc,dd,ee>;
CH:=CharacterTable(N);
/*We will look for subgroup of £N£ which have a Faithful
induce character of N */
S:=Subgroups(N);
/* for i in [1..#S] do if #S[i]‘subgroup eq 8 then i; end if;
end for;*/

H:=S[33]‘subgroup;
#H;
ch:=CharacterTable(H);
ch;
/* I:=Induction(ch[2],N);
I;
( 4, 4, 0, 0, 0, 0, -4, 0, 0, 0, 0, 0, 0, 4, -4, 0, 0 )
Norm(I);
4
wrong */

I:=Induction(ch[3],N);

```

```

I;
IsFaithful(I);
Norm(I);
CH[17] eq I;
T:=Transversal(N,H);
T;
C:=Classes(H);
C;
H:=sub<N|(1, 3, 4, 8)(2, 6, 5, 7),(1, 6)(2, 8)(3, 5)(4, 7),
(1, 4)(2, 5)(3, 8)(6, 7)>;
/*We will find all the Matrices*/
F:=H;
C:=CyclotomicField(4);

A:= [0: i in [1..16]];
for i in [1..4] do if aa*T[i]^-1 in F then if
ch[3](aa*T[i]^-1) eq C.1
then A[i]:=2; else if ch[3](aa*T[i]^-1) eq C.1^3 then A[i]:=3;
else A[i]:= ch[3](aa*T[i]^-1); end if; end if; end if; end for;

for i in [1..4] do if T[2]*aa*T[i]^-1 in F then if
ch[3](T[2]*aa*T[i]^-1) eq C.1
then A[4+i]:=2; else if ch[3](T[2]*aa*T[i]^-1) eq C.1^3 then
A[4+i]:=3; else A[4+i]:= ch[3](T[2]*aa*T[i]^-1); end if;
end if; end if;
end for;

for i in [1..4] do if T[3]*aa*T[i]^-1 in F then if
ch[3](T[3]*aa*T[i]^-1) eq C.1
then A[8+i]:=2; else if ch[3](T[3]*aa*T[i]^-1) eq C.1^3 then
A[8+i]:=3; else
A[8+i]:= ch[3](T[3]*aa*T[i]^-1); end if; end if; end if;
end for;

for i in [1..4] do if T[4]*aa*T[i]^-1 in F then if
ch[3](T[4]*aa*T[i]^-1) eq C.1
then A[12+i]:=2; else if ch[3](T[4]*aa*T[i]^-1) eq C.1^3 then
A[12+i]:=3; else A[12+i]:= ch[3](T[4]*aa*T[i]^-1); end if;
end if; end if; end for;

A;
-----
C:=CyclotomicField(4);
B:= [0: i in [1..16]];

```

```

for i in [1..4] do if bb*T[i]^-1 in F then if
ch[3](bb*T[i]^-1) eq C.1
then B[i]:=2; else if ch[3](bb*T[i]^-1) eq C.1^3 then B[i]:=3;
else B[i]:= ch[3](bb*T[i]^-1); end if; end if; end if; end for;

```

```

for i in [1..4] do if T[2]*bb*T[i]^-1 in F then if
ch[3](T[2]*bb*T[i]^-1) eq C.1
then B[4+i]:=2; else if ch[3](T[2]*bb*T[i]^-1) eq C.1^3 then
B[4+i]:=3; else B[4+i]:= ch[3](T[2]*bb*T[i]^-1); end if; end if;
end if; end for;

```

```

for i in [1..4] do if T[3]*bb*T[i]^-1 in F then if
ch[3](T[3]*bb*T[i]^-1) eq C.1
then B[8+i]:=2; else if ch[3](T[3]*bb*T[i]^-1) eq C.1^3 then
B[8+i]:=3; else
B[8+i]:= ch[3](T[3]*bb*T[i]^-1); end if; end if; end if;
end for;

```

```

for i in [1..4] do if T[4]*bb*T[i]^-1 in F then if
ch[3](T[4]*bb*T[i]^-1) eq C.1
then B[12+i]:=2; else if ch[3](T[4]*bb*T[i]^-1) eq C.1^3 then
B[12+i]:=3; else B[12+i]:= ch[3](T[4]*bb*T[i]^-1); end if;
end if; end if; end for;

```

B;

-----  
C:=CyclotomicField(4);

CC:=[0: i in [1..16]];

```

for i in [1..4] do if cc*T[i]^-1 in F then if
ch[3](cc*T[i]^-1) eq C.1
then CC[i]:=2; else if ch[3](cc*T[i]^-1) eq C.1^3 then CC[i]:=3;
else CC[i]:= ch[3](cc*T[i]^-1); end if; end if; end if; end for;

```

```

for i in [1..4] do if T[2]*cc*T[i]^-1 in F then if
ch[3](T[2]*cc*T[i]^-1) eq C.1
then CC[4+i]:=2; else if ch[3](T[2]*cc*T[i]^-1) eq C.1^3 then
CC[4+i]:=3; else CC[4+i]:= ch[3](T[2]*cc*T[i]^-1); end if;
end if; end if; end for;

```

```

for i in [1..4] do if T[3]*cc*T[i]^-1 in F then if
ch[3](T[3]*cc*T[i]^-1) eq C.1
then CC[8+i]:=2; else if ch[3](T[3]*cc*T[i]^-1) eq C.1^3 then

```

```

CC[8+i]:=3; else
CC[8+i]:= ch[3](T[3]*cc*T[i]^-1); end if; end if; end if;
end for;

for i in [1..4] do if T[4]*cc*T[i]^-1 in F then if
ch[3](T[4]*cc*T[i]^-1) eq C.1
then CC[12+i]:=2; else if ch[3](T[4]*cc*T[i]^-1) eq C.1^3 then
CC[12+i]:=3; else CC[12+i]:= ch[3](T[4]*cc*T[i]^-1); end if;
end if; end if; end for;

CC;
-----
C:=CyclotomicField(4);
D:=[0: i in [1..16]];

for i in [1..4] do if dd*T[i]^-1 in F then if
ch[3](dd*T[i]^-1) eq C.1
then D[i]:=2; else if ch[3](dd*T[i]^-1) eq C.1^3 then D[i]:=3;
else D[i]:= ch[3](dd*T[i]^-1); end if; end if; end if; end for;

for i in [1..4] do if T[2]*dd*T[i]^-1 in F then if
ch[3](T[2]*dd*T[i]^-1) eq C.1
then D[4+i]:=2; else if ch[3](T[2]*dd*T[i]^-1) eq C.1^3 then
D[4+i]:=3; else D[4+i]:= ch[3](T[2]*dd*T[i]^-1); end if;
end if; end if; end for;

for i in [1..4] do if T[3]*dd*T[i]^-1 in F then if
ch[3](T[3]*dd*T[i]^-1) eq C.1
then D[8+i]:=2; else if ch[3](T[3]*dd*T[i]^-1) eq C.1^3 then
D[8+i]:=3; else
D[8+i]:= ch[3](T[3]*dd*T[i]^-1); end if; end if; end if;
end for;

for i in [1..4] do if T[4]*dd*T[i]^-1 in F then if
ch[3](T[4]*dd*T[i]^-1) eq C.1
then D[12+i]:=2; else if ch[3](T[4]*dd*T[i]^-1) eq C.1^3 then
D[12+i]:=3; else D[12+i]:= ch[3](T[4]*dd*T[i]^-1); end if;
end if; end if; end for;

D;
-----
C:=CyclotomicField(4);
E:=[0: i in [1..16]];

```

```

for i in [1..4] do if ee*T[i]^-1 in F then if
ch[3](ee*T[i]^-1) eq C.1
then E[i]:=2; else if ch[3](ee*T[i]^-1) eq C.1^3 then E[i]:=3;
else E[i]:= ch[3](ee*T[i]^-1); end if; end if; end if; end for;

```

```

for i in [1..4] do if T[2]*ee*T[i]^-1 in F then if
ch[3](T[2]*ee*T[i]^-1) eq C.1
then E[4+i]:=2; else if ch[3](T[2]*ee*T[i]^-1) eq C.1^3 then
E[4+i]:=3; else E[4+i]:= ch[3](T[2]*ee*T[i]^-1); end if;
end if; end if; end for;

```

```

for i in [1..4] do if T[3]*ee*T[i]^-1 in F then if
ch[3](T[3]*ee*T[i]^-1) eq C.1
then E[8+i]:=2; else if ch[3](T[3]*ee*T[i]^-1) eq C.1^3 then
E[8+i]:=3; else
E[8+i]:= ch[3](T[3]*ee*T[i]^-1); end if; end if; end if;
end for;

```

```

for i in [1..4] do if T[4]*ee*T[i]^-1 in F then if
ch[3](T[4]*ee*T[i]^-1) eq C.1
then E[12+i]:=2; else if ch[3](T[4]*ee*T[i]^-1) eq C.1^3 then
E[12+i]:=3; else E[12+i]:= ch[3](T[4]*ee*T[i]^-1); end if;
end if; end if; end for;

```

E;

```

-----
G:=GL(4,5);
Order(G!A);Order(G!B);Order(G!CC);Order(G!D);Order(G!E);
M:=sub<G/A,B,CC,D,E>;
#M;
s:=IsIsomorphic(M,N);
s;

```

```

/* I label the ti's by (t1,t2,t3,t4,t1^2,t2^2,t3^2,t4^2,...,
t1^4,t2^4,t3^4,t4^4) start with 1 to 16 to find
the Monomial Permatations*/

```

```

S:=Sym(16);
aa:=S! (1, 2)(3, 4)(5, 6)(7, 8)(9, 10)(11, 12)(13, 14)(15, 16);
bb:=S! (1, 3)(2, 16)(5, 7)(6, 12)(9, 11)(10, 8)(13, 15)(14, 4);
cc:=S! (1, 4)(2, 3)(5, 8)(6, 7)(9, 12)(10, 11)(13, 16)(14, 15);
dd:=S! (1, 6)(5, 14)(9, 2)(13, 10)(3, 12)(7, 4)(11, 16)(15, 8);
ee:=S! (1, 13)(5, 9)(2, 14)(6, 10)(3, 15)(7, 11)(4, 16)(8, 12);
N:=sub<S/aa,bb,cc,dd,ee>;

```

```

-----

/* Other way to write the matrix */

A:= [0: i in [1..16]];
for i in [1..4] do if aa*T[i]^-1 in H then i, ch[3](aa*T[i]^-1);
end if; end for;
for i in [1..4] do if T[2]*aa*T[i]^-1 in H then i,
ch[3](T[2]*aa*T[i]^-1); end if; end for;
for i in [1..4] do if T[3]*aa*T[i]^-1 in H then i,
ch[3](T[3]*aa*T[i]^-1); end if; end for;
for i in [1..4] do if T[4]*aa*T[i]^-1 in H then i,
ch[3](T[4]*aa*T[i]^-1); end if; end for;

A:= [0: i in [1..16]];
A[2]:=1; A[5]:=1; A[12]:=1; A[15]:=1;

G:=GL(4,5);
Order(G!A);
aa;

B:= [0: i in [1..16]];
for i in [1..4] do if bb*T[i]^-1 in H then i, ch[3](bb*T[i]^-1);
end if; end for;
for i in [1..4] do if T[2]*bb*T[i]^-1 in H then i,
ch[3](T[2]*bb*T[i]^-1); end if; end for;
for i in [1..4] do if T[3]*bb*T[i]^-1 in H then i,
ch[3](T[3]*bb*T[i]^-1); end if; end for;
for i in [1..4] do if T[4]*bb*T[i]^-1 in H then i,
ch[3](T[4]*bb*T[i]^-1); end if; end for;

B:= [0: i in [1..16]];
B[3]:=1; B[8]:=-1; B[9]:=1; B[14]:=-1;
G:=GL(4,5);
Order(G!B);
bb;

C:= [0: i in [1..16]];
for i in [1..4] do if cc*T[i]^-1 in H then i, ch[3](cc*T[i]^-1);
end if; end for;
for i in [1..4] do if T[2]*cc*T[i]^-1 in H then i,
ch[3](T[2]*cc*T[i]^-1); end if; end for;

```

```

for i in [1..4] do if T[3]*cc*T[i]^-1 in H then i,
ch[3](T[3]*cc*T[i]^-1); end if; end for;
for i in [1..4] do if T[4]*cc*T[i]^-1 in H then i,
ch[3](T[4]*cc*T[i]^-1); end if; end for;

C:= [0: i in [1..16]];
C[4]:=1; C[7]:=1; C[10]:=1; C[13]:=1;

G:=GL(4,5);
Order(G!C);
cc;

D:= [0: i in [1..16]];
for i in [1..4] do if dd*T[i]^-1 in H then i, ch[3](dd*T[i]^-1);
end if; end for;
for i in [1..4] do if T[2]*dd*T[i]^-1 in H then i,
ch[3](T[2]*dd*T[i]^-1); end if; end for;
for i in [1..4] do if T[3]*dd*T[i]^-1 in H then i,
ch[3](T[3]*dd*T[i]^-1); end if; end for;
for i in [1..4] do if T[4]*dd*T[i]^-1 in H then i,
ch[3](T[4]*dd*T[i]^-1); end if; end for;
D:= [0: i in [1..16]];
D[2]:=2; D[5]:=3; D[12]:=3; D[15]:=2;
G:=GL(4,5);
Order(G!D);
dd;

E:= [0: i in [1..16]];
for i in [1..4] do if ee*T[i]^-1 in H then i, ch[3](ee*T[i]^-1);
end if; end for;
for i in [1..4] do if T[2]*ee*T[i]^-1 in H then i,
ch[3](T[2]*ee*T[i]^-1); end if; end for;
for i in [1..4] do if T[3]*ee*T[i]^-1 in H then i,
ch[3](T[3]*ee*T[i]^-1); end if; end for;
for i in [1..4] do if T[4]*ee*T[i]^-1 in H then i,
ch[3](T[4]*ee*T[i]^-1); end if; end for;
E:= [0: i in [1..16]];
E[1]:=-1; E[6]:=-1; E[11]:=-1; E[16]:=-1;
G:=GL(4,5);
Order(G!E);
ee;
A;B;C;D;E;
-----
M:=sub<G/A,B,C,D,E>;

```



```

#M;

/* I label the tis by (t1,t2,t3,t4,t1^2,t2^2,t3^2,t4^2,...,
  t1^4,t2^4,t3^4,t4^4)
start with 1 to 16 to find the Monomial Permatations*/

S:=Sym(16);
aa:=S! (1, 2)(3, 4)(5, 6)(7, 8)(9, 10)(11, 12)(13, 14)(15, 16);
bb:=S! (1, 3)(2, 16)(5, 7)(6, 12)(9, 11)(10, 8)(13, 15)(14, 4);
cc:=S! (1, 4)(2, 3)(5, 8)(6, 7)(9, 12)(10, 11)(13, 16)(14, 15);
dd:=S! (1, 6)(5, 14)(9, 2)(13, 10)(3, 12)(7, 4)(11, 16)(15, 8);
ee:=S! (1, 13)(5, 9)(2, 14)(6, 10)(3, 15)(7, 11)(4, 16)(8, 12);
N:=sub<S/aa,bb,cc,dd,ee>;
G<a,b,c,d,e>:=Group<a,b,c,d,e/a^2=b^2=c^2=d^2=e^2=1,b^a=b*e,
c^a=c,c^b=c*e,d^a=d*e,d^b=d,d^c=d,e^a=e,e^b=e,e^c=e,e^d=e>;

f,G1,k:=CosetAction(G,sub<G/Id(G)>);
s:=IsIsomorphic(G1,N);
s;
s:=IsIsomorphic(M,N);
s;

/*The set stabilizer in S(5) of the set
{t1,t1^2,t1^3,t1^4}=1,5,9,13.
Now continue and write a presentation for the progenitor
5^{\star 4}:N.*/

Sch:=SchreierSystem(G,sub<G/Id(G)>);
ArrayP:=[Id(N): i in [1..12]];
for i in [2..32] do
P:=[Id(N): l in [1..#Sch[i]]];
for j in [1..#Sch[i]] do
if Eltseq(Sch[i])[j] eq 1 then P[j]:=aa; end if;
if Eltseq(Sch[i])[j] eq 2 then P[j]:=bb; end if;
if Eltseq(Sch[i])[j] eq 3 then P[j]:=cc; end if;
if Eltseq(Sch[i])[j] eq 4 then P[j]:=dd; end if;
if Eltseq(Sch[i])[j] eq 5 then P[j]:=ee; end if;
end for;
PP:=Id(N);
for k in [1..#P] do
PP:=PP*P[k]; end for;
ArrayP[i]:=PP;
end for;
for i in [1..32] do Sch[i], ArrayP[i]; end for;

```

```

N15913:=Stabiliser(N,{1,5,9,13});
N15913;
/*
Permutation group N15913 acting on a set of cardinality 16
Order = 8 = 2^3
      (2, 14)(4, 16)(6, 10)(8, 12)
      (1, 13)(2, 14)(3, 15)(4, 16)(5, 9)(6, 10)(7, 11)(8, 12)
      (1, 5, 13, 9)(2, 10, 14, 6)(3, 11, 15, 7)(4, 8, 16, 12)
*/
/* So the presentation for the monomial progenitor  $5^{\star 4}:N$ 
is giving by*/
G<a,b,c,d,e,t>:=Group<a,b,c,d,e,t/a^2=b^2=c^2=d^2=e^2=1,b^a=b*e,
c^a=c,c^b=c*e,d^a=d*e,d^b=d,d^c=d,e^a=e,e^b=e,e^c=e,e^d=e,t^5,
t^(a*c*b)=t,t^(c*b*d)=t^2>;
/*By adding some relations we got the following*/
for h,i in [0..10] do
G<a,b,c,d,e,t>:=Group<a,b,c,d,e,t/a^2=b^2=c^2=d^2=e^2=1,b^a=b*e,
c^a=c,c^b=c*e,d^a=d*e,d^b=d,d^c=d,e^a=e,e^b=e,e^c=e,e^d=e,t^5,
t^(a*c*b)=t,t^(c*b*d)=t^2,(e*t*t^(c*e))^h,((b*e)*t*t^d)^i>;
if #G gt 32 then h,i, Index(G,sub<G/a,b,c,d,e>), #G; end if;
end for;
/*
2 3 900 28800
*/
/* To Verify that our progenitor is correct:*/

G<a,b,c,d,e,t>:=Group<a,b,c,d,e,t/a^2=b^2=c^2=d^2=e^2=1,b^a=b*e,
c^a=c,c^b=c*e,d^a=d*e,d^b=d,d^c=d,e^a=e,e^b=e,e^c=e,e^d=e,t^5,
t^(a*c*b)=t,t^(c*b*d)=t^2,(e*t*t^(c*e))^2,((b*e)*t*t^d)^3>;
#G;

f,G1,k:=CosetAction(G,sub<G/a,b,c,d,e>);
#G1;
#k;
IN:=sub<G1/f(a),f(b),f(c),f(d),f(e)>;
T:=sub<G1/f(t)>;
# Normalizer(IN,T);

/* add more relations*/

for g,h,u,r in [0..10] do
G<a,b,c,d,e,t>:=Group<a,b,c,d,e,t/a^2=b^2=c^2=d^2=e^2=1,b^a=b*e,
c^a=c,c^b=c*e,d^a=d*e,d^b=d,d^c=d,e^a=e,e^b=e,e^c=e,e^d=e,t^5,
t^(a*c*b)=t,t^(c*b*d)=t^2,(b*c*d*t)^g,(a*d*e*t)^h,(a*b*c*d*t)^u,

```

```

(a*c*d*t)^r>;
if #G gt 32 then g,h,u,r, Index(G,sub<G/a,b,c,d,e>), #G; end if;
end for;

/* add other relations*/
for g,h,u,r in [0..10] do
G<a,b,c,d,e,t>:=Group<a,b,c,d,e,t/a^2=b^2=c^2=d^2=e^2=1,b^a=b*e,
c^a=c,c^b=c*e,d^a=d*e,d^b=d,d^c=d,e^a=e,e^b=e,e^c=e,e^d=e,t^5,
t^(a*c*b)=t,t^(c*b*d)=t^2,(c*d*t)^g,(a*b*d*t)^h,(a*b*d*t^b)^u,
(a*b*e*t)^r>;
if #G gt 32 then g,h,u,r, Index(G,sub<G/a,b,c,d,e>), #G; end if;
end for;
0 0 3 4 900 28800

```

## Appendix K

# MAGMA Code for Monomial Progenitor $7^*8 :_m (3^2 : 2^4)$

```

S:=Sym(9);
aa:=S!(2, 3, 4, 8, 5, 7, 9, 6);
bb:=S!(2, 4)(3, 7)(5, 9);
cc:=S!(2, 4, 5, 9)(3, 8, 7, 6);
dd:=S!(2, 5)(3, 7)(4, 9)(6, 8);
ee:=S!(1, 2, 5)(3, 6, 9)(4, 8, 7);
ff:=S!(1, 3, 7)(2, 6, 4)(5, 9, 8);
N:=sub<S|aa,bb,cc,dd,ee,ff>;
CH:=CharacterTable(N);
CH;
/* To feger the order of the subgroup we will
   see the CH table and we sow 2,8 the order of
   the subgroup has devide the ordre of the group
   so (144 / 2 desn't give me integer #) but 144/8=18
   so the subgroup has to be of ordr 18*/

/* S:=Subgroups(N);
for i in [1..#S] do if #S[i]'subgroup eq 18 then i; end if;
end for;
H:=S[22]'subgroup;
#H;
ch:=CharacterTable(H);
ch;
I:=Induction(ch[4],N);
I;
IsFaithful(I);

```

*Because the (I) not Faithful we will try other  
subgroup with other order \*/*

```
S:=Subgroups(N);
for i in [1..#S] do if #S[i]'subgroup eq 18 then i; end if;
end for;
H:=S[17]'subgroup;
#H;
ch:=CharacterTable(H);
ch;
I:=Induction(ch[3],N);
I;
IsFaithful(I);
Norm(I);
CH[9] eq I;
T:=Transversal(N,H);
T;
```

```
/* G=He U H(2, 3, 4, 8, 5, 7, 9, 6) U H(2, 4, 5, 9)
(3, 8, 7, 6) U H(2, 5)(3, 7)(4, 9)(6, 8) U
H(2, 7, 5, 3)(4, 8, 9, 6) U H(2, 7, 4, 6, 5, 3
, 9, 8) U H(2, 9, 5, 4)(3, 6, 7, 8) U
H(2, 6, 9, 7, 5, 8, 4, 3) ,
So there are 8 tis and each one has 6 degrees */
```

```
A:= [0: i in [1..64]];
for i in [1..8] do if aa*T[i]^-1 in H then
A[i]:= ch[3](aa*T[i]^-1); end if; end for;
for i in [1..8] do if T[2]*aa*T[i]^-1 in H then
A[8+i]:= ch[3](T[2]*aa*T[i]^-1); end if; end for;
for i in [1..8] do if T[3]*aa*T[i]^-1 in H then
A[16+i]:= ch[3](T[3]*aa*T[i]^-1); end if; end for;
for i in [1..8] do if T[4]*aa*T[i]^-1 in H then
A[24+i]:= ch[3](T[4]*aa*T[i]^-1); end if; end for;
for i in [1..8] do if T[5]*aa*T[i]^-1 in H then
A[32+i]:= ch[3](T[5]*aa*T[i]^-1); end if; end for;
for i in [1..8] do if T[6]*aa*T[i]^-1 in H then
A[40+i]:= ch[3](T[6]*aa*T[i]^-1); end if; end for;
for i in [1..8] do if T[7]*aa*T[i]^-1 in H then
A[48+i]:= ch[3](T[7]*aa*T[i]^-1); end if; end for;
for i in [1..8] do if T[8]*aa*T[i]^-1 in H then
A[56+i]:= ch[3](T[8]*aa*T[i]^-1); end if; end for;
A;
A:= [0: i in [1..64]];
```

```

A[2]:=1; A[11]:=1;A[21]:=1; A[30]:=1;A[36]:=1;
A[47]:=1;A[56]:=1; A[57]:=1;
G:=GL(8,7);
Order(G!A);
aa;

```

```

-----
B:=[0: i in [1..64]];
for i in [1..8] do if bb*T[i]^-1 in H then
B[i]:= ch[3](bb*T[i]^-1); end if; end for;
for i in [1..8] do if T[2]*bb*T[i]^-1 in H then
B[8+i]:= ch[3](T[2]*bb*T[i]^-1); end if; end for;
for i in [1..8] do if T[3]*bb*T[i]^-1 in H then
B[16+i]:= ch[3](T[3]*bb*T[i]^-1); end if; end for;
for i in [1..8] do if T[4]*bb*T[i]^-1 in H then
B[24+i]:= ch[3](T[4]*bb*T[i]^-1); end if; end for;
for i in [1..8] do if T[5]*bb*T[i]^-1 in H then
B[32+i]:= ch[3](T[5]*bb*T[i]^-1); end if; end for;
for i in [1..8] do if T[6]*bb*T[i]^-1 in H then
B[40+i]:= ch[3](T[6]*bb*T[i]^-1); end if; end for;
for i in [1..8] do if T[7]*bb*T[i]^-1 in H then
B[48+i]:= ch[3](T[7]*bb*T[i]^-1); end if; end for;
for i in [1..8] do if T[8]*bb*T[i]^-1 in H then
B[56+i]:= ch[3](T[8]*bb*T[i]^-1); end if; end for;
B;
B:=[0: i in [1..64]];
B[1]:=1; B[13]:=1; B[23]:=1; B[28]:=1; B[34]:=1;
B[48]:=1; B[51]:=1; B[62]:=1;
G:=GL(8,7);
Order(G!B);
bb;

```

```

-----
C:=[0: i in [1..64]];
for i in [1..8] do if cc*T[i]^-1 in H then
C[i]:= ch[3](cc*T[i]^-1); end if; end for;
for i in [1..8] do if T[2]*cc*T[i]^-1 in H then
C[8+i]:= ch[3](T[2]*cc*T[i]^-1); end if; end for;
for i in [1..8] do if T[3]*cc*T[i]^-1 in H then
C[16+i]:= ch[3](T[3]*cc*T[i]^-1); end if; end for;
for i in [1..8] do if T[4]*cc*T[i]^-1 in H then
C[24+i]:= ch[3](T[4]*cc*T[i]^-1); end if; end for;
for i in [1..8] do if T[5]*cc*T[i]^-1 in H then
C[32+i]:= ch[3](T[5]*cc*T[i]^-1); end if; end for;
]for i in [1..8] do if T[6]*cc*T[i]^-1 in H then
C[40+i]:= ch[3](T[6]*cc*T[i]^-1); end if; end for;

```

```

for i in [1..8] do if T[7]*cc*T[i]^-1 in H then
C[48+i]:= ch[3](T[7]*cc*T[i]^-1); end if; end for;
for i in [1..8] do if T[8]*cc*T[i]^-1 in H then
C[56+i]:= ch[3](T[8]*cc*T[i]^-1); end if; end for;
C;
C:= [0: i in [1..64]];
C[3]:=1; C[13]:=1; C[20]:=1; C[31]:=1; C[38]:=1;
C[48]:=1; C[49]:=1; C[58]:=1;
G:=GL(8,7);
Order(G!C);
cc;

```

```

-----
D:= [0: i in [1..64]];
for i in [1..8] do if dd*T[i]^-1 in H then
D[i]:= ch[3](dd*T[i]^-1); end if; end for;
for i in [1..8] do if T[2]*dd*T[i]^-1 in H then
D[8+i]:= ch[3](T[2]*dd*T[i]^-1); end if; end for;
for i in [1..8] do if T[3]*dd*T[i]^-1 in H then
D[16+i]:= ch[3](T[3]*dd*T[i]^-1); end if; end for;
for i in [1..8] do if T[4]*dd*T[i]^-1 in H then
D[24+i]:= ch[3](T[4]*dd*T[i]^-1); end if; end for;
for i in [1..8] do if T[5]*dd*T[i]^-1 in H then
D[32+i]:= ch[3](T[5]*dd*T[i]^-1); end if; end for;
for i in [1..8] do if T[6]*dd*T[i]^-1 in H then
D[40+i]:= ch[3](T[6]*dd*T[i]^-1); end if; end for;
for i in [1..8] do if T[7]*dd*T[i]^-1 in H then
D[48+i]:= ch[3](T[7]*dd*T[i]^-1); end if; end for;
for i in [1..8] do if T[8]*dd*T[i]^-1 in H then
D[56+i]:= ch[3](T[8]*dd*T[i]^-1); end if; end for;
D;
D:= [0: i in [1..64]];
D[4]:=1; D[14]:=1; D[23]:=1; D[25]:=1; D[40]:=1;
D[42]:=1; D[51]:=1; D[61]:=1;
G:=GL(8,7);
Order(G!D);
dd;

```

```

-----
E:= [0: i in [1..64]];
for i in [1..8] do if ee*T[i]^-1 in H then i,
ch[3](ee*T[i]^-1); end if; end for;
for i in [1..8] do if T[2]*ee*T[i]^-1 in H then i,
ch[3](T[2]*ee*T[i]^-1); end if; end for;
for i in [1..8] do if T[3]*ee*T[i]^-1 in H then i,
ch[3](T[3]*ee*T[i]^-1); end if; end for;

```

```

for i in [1..8] do if T[4]*ee*T[i]^-1 in H then i,
  ch[3](T[4]*ee*T[i]^-1); end if; end for;
for i in [1..8] do if T[5]*ee*T[i]^-1 in H then i,
  ch[3](T[5]*ee*T[i]^-1); end if; end for;
for i in [1..8] do if T[6]*ee*T[i]^-1 in H then i,
  ch[3](T[6]*ee*T[i]^-1); end if; end for;
for i in [1..8] do if T[7]*ee*T[i]^-1 in H then i,
  ch[3](T[7]*ee*T[i]^-1); end if; end for;
for i in [1..8] do if T[8]*ee*T[i]^-1 in H then i,
  ch[3](T[8]*ee*T[i]^-1); end if; end for;

```

```

E:= [0: i in [1..64]];
E[1]:=4; E[10]:=4; E[19]:=2; E[28]:=2; E[37]:=1;
E[46]:=2; E[55]:=4; E[64]:=1;
G:=GL(8,7);
Order(G!E);
ee;

```

```

-----
F:= [0: i in [1..64]];
for i in [1..8] do if ff*T[i]^-1 in H then i,
  ch[3](ff*T[i]^-1); end if; end for;
for i in [1..8] do if T[2]*ff*T[i]^-1 in H then i,
  ch[3](T[2]*ff*T[i]^-1); end if; end for;
for i in [1..8] do if T[3]*ff*T[i]^-1 in H then i,
  ch[3](T[3]*ff*T[i]^-1); end if; end for;
for i in [1..8] do if T[4]*ff*T[i]^-1 in H then i,
  ch[3](T[4]*ff*T[i]^-1); end if; end for;
for i in [1..8] do if T[5]*ff*T[i]^-1 in H then i,
  ch[3](T[5]*ff*T[i]^-1); end if; end for;
for i in [1..8] do if T[6]*ff*T[i]^-1 in H then i,
  ch[3](T[6]*ff*T[i]^-1); end if; end for;
for i in [1..8] do if T[7]*ff*T[i]^-1 in H then i,
  ch[3](T[7]*ff*T[i]^-1); end if; end for;
for i in [1..8] do if T[8]*ff*T[i]^-1 in H then i,
  ch[3](T[8]*ff*T[i]^-1); end if; end for;

```

```

F;
F:= [0: i in [1..64]];
F[1]:=1; F[10]:=4; F[19]:=4; F[28]:=1; F[37]:=2; F[46]:=2;
F[55]:=2; F[64]:=4;
G:=GL(8,7);
Order(G!F);
ff;

```

```

-----
A;B;C;D;E;F;

```



```

M:=sub<G/A,B,C,D,F>;
#M;

/* I label the tis by (t1,t2,t3,t4,t5,t6,t7,t8,t1^2,t2^2,...,
t1^6,t2^6,t3^6,t4^6,t5^6,t6^6,t7^6,t8^6) start with 1 to 64 */

S:=Sym(48);
aa:=S!(1,2,3,5,4,6,7,8)(9,10,11,13,12,14,15,16)(17,18,19,21,20
,22,23,24)(25,26,27,29,28,30,31,32)(33,34,35,37,36,38,39,40)
(41,42,43,45,44,46,47,48);
bb:=S!(2,5)(3,7)(6,8)(10,13)(11,15)(14,16)(18,21)(19,23)
(22,24)(26,29)(27,31)(30,32)(34,37)(35,39)(38,40)
(42,45)(43,47)(46,48);
cc:=S!(1,3,4,7)(2,5,6,8)(9,11,12,15)(10,13,14,16)
(17,19,20,23)(18,21,22,24)(25,27,28,31)(26,29,
30,32)(33,35,36,39)(34,37,38,40)(41,43,44,47)
(42,45,46,48);
dd:=S!(1,4)(2,6)(3,7)(5,8)(9,12)(10,14)(11,15)(13,16)
(17,20)(18,22)(19,23)(21,24)(25,28)(26,30)(27,31)
(29,32)(33,36)(34,38)(35,39)(37,40)(41,44)(42,46)
(43,47)(45,48);
ee:=S!(1,25,9)(2,26,10)(3,11,27)(4,12,28)(6,14,30)
(7,31,15)(17,33,41)(18,34,42)(19,43,35)(20,44
,36)(22,46,38)(23,39,47);
ff:=S!(2,26,10)(3,27,11)(5,13,29)(6,14,30)(7,15,31)
(8,32,16)(18,34,42)(19,35,43)(21,45,37)(22,46,
38)(23,47,39)(24,40,48);
N:=sub<S/aa,bb,cc,dd,ee,ff>;

G<a,b,c,d,e,f>:=Group<a,b,c,d,e,f/a^8,b^2,c^4,d^2,e^3,f^3,(e,f),
a^2=c,c^2=d,b^a=b*c*d,c^a=c,c^b=c*d,d^a=d,d^b=d,d^c=d,e^a=f,
e^b=e*(f^2),e^c=e*(f^2),e^d=e^2,f^a=e*(f^2),f^b=f^2,
f^c=(e^2)*(f^2),f^d=f^2,f^e=f>;
#G;
f,G1,k:=CosetAction(G,sub<G/Id(G)>);
s:=IsIsomorphic(G1,N);
s;
s:=IsIsomorphic(M,N);
s;
/* the set stabilizer in S(7) of the set
{t1,t1^2,t1^3,t1^4,t1^5,t1^6}=1,9,17,25,33,41,49,57
Now continue and write a presentation for
the progenitor 7^{\star 8}:N.*/

```

```

Sch:=SchreierSystem(G,sub<G/Id(G)>);
ArrayP:=Id(N): i in [1..144];
for i in [2..144] do
P:=Id(N): l in [1..#Sch[i]];
for j in [1..#Sch[i]] do
if Eltseq(Sch[i])[j] eq 1 then P[j]:=aa; end if;
if Eltseq(Sch[i])[j] eq -1 then P[j]:=aa^-1; end if;
if Eltseq(Sch[i])[j] eq 2 then P[j]:=bb; end if;
if Eltseq(Sch[i])[j] eq 3 then P[j]:=cc; end if;
if Eltseq(Sch[i])[j] eq -3 then P[j]:=cc^-1; end if;
if Eltseq(Sch[i])[j] eq 4 then P[j]:=dd; end if;
if Eltseq(Sch[i])[j] eq 5 then P[j]:=ee; end if;
if Eltseq(Sch[i])[j] eq -5 then P[j]:=ee^-1; end if;
if Eltseq(Sch[i])[j] eq 6 then P[j]:=ff; end if;
if Eltseq(Sch[i])[j] eq -6 then P[j]:=ff^-1; end if;
end for;
PP:=Id(N);
for k in [1..#P] do
PP:=PP*P[k]; end for;
ArrayP[i]:=PP;
end for;
for i in [1..144] do Sch[i], ArrayP[i]; end for;
N1917253341:=Stabiliser(N,{1,9,17,25,33,41});
N1917253341;
Orbits(Stabiliser(N,{1,9,17,25,33,41}));
for g in N do if 2^g eq 29 then g; end if; end for;

/* So the presentation for the monomial progenitor
 $\Gamma^{\{ \star 8 \}}:N$  is giving by*/
G<a,b,c,d,e,f,t>:=Group<a,b,c,d,e,f,t|a^8,b^2,c^4,d^2,
e^3,f^3,(e,f),a^2=c,c^2=d,b^a=b*c*d,c^a=c,c^b=c*d,d^a=d,
d^b=d,d^c=d,e^a=f,e^b=e*(f^2),e^c=e*(f^2),e^d=e^2,
f^a=e*(f^2),f^b=f^2,f^c=(e^2)*(f^2),f^d=f^2,f^e=f,t^7,
t^(b)=t,t^(b*f^-1)=t,(t^e)=t^4>;

/* To Verify that your progenitor is correct:*/

G<a,b,c,d,e,f,t>:=Group<a,b,c,d,e,f,t|a^8,b^2,c^4,d^2,
e^3,f^3,(e,f),a^2=c,c^2=d,b^a=b*c*d,c^a=c,c^b=c*d,d^a=d,
d^b=d,d^c=d,e^a=f,e^b=e*(f^2),e^c=e*(f^2),e^d=e^2,
f^a=e*(f^2),f^b=f^2,f^c=(e^2)*(f^2),f^d=f^2,f^e=f,t^7,
t^(b)=t,t^(b*f^-1)=t,t^e=t^4,(t,t^a),(t,t^c),(t,t^d),
(t,t^(a*d))>;
#G;

```

```

V:=CosetSpace(G,sub<G/a,b,c,d,e,f>: CosetLimit:=10000000,
Hard:=true, Print:=1);
G:=CosetImage(V);
print Index(G,sub<G/a,b,c,d,e,f>: CosetLimit:=5^10,
Hard:=true, Print:=2);
f,G1,k:=CosetAction(G,sub<G/a,b,c,d,e,f>);
#G1;
#k;
IN:=sub<G1/f(a),f(b),f(c),f(d),f(e),f(f)>;
T:=sub<G1/f(t)>;
# Normalizer(IN,T);

/* Add relation to G */

for k,g,m in [0..10] do
G<a,b,c,d,e,f,t>:=Group<a,b,c,d,e,f,t/a^8,b^2,c^4,d^2,
e^3,f^3,(e,f),a^2=c,c^2=d,b^a=b*c*d,c^a=c,c^b=c*d,
d^a=d,d^b=d,d^c=d,e^a=f,e^b=e*(f^2),e^c=e*(f^2),e^d=e^2,
f^a=e*(f^2),f^b=f^2,f^c=(e^2)*(f^2),f^d=f^2,f^e=f,t^7,
t^(b)=t,t^(b*f^-1)=t,t^e=t^4,(t,t^a),(t,t^c),(t,t^d),
(t,t^(a*d)),(e*b*t^e)^k,(a*t)^g,(a*d*t^e)^m>;
if #G gt 144 then k,g,m, Index(G,sub<G/a,b,c,d,e,f>),
#G; end if; end for;

/* Add relation to G */

for k,g,m in [0..10] do
G<a,b,c,d,e,f,t>:=Group<a,b,c,d,e,f,t/a^8,b^2,c^4,d^2,
e^3,f^3,(e,f),a^2=c,c^2=d,b^a=b*c*d,c^a=c,c^b=c*d,d^a=d,
d^b=d,d^c=d,e^a=f,e^b=e*(f^2),e^c=e*(f^2),e^d=e^2,
f^a=e*(f^2),f^b=f^2,f^c=(e^2)*(f^2),f^d=f^2,f^e=f,t^7,
t^(b)=t,t^(b*f^-1)=t,t^e=t^4,(t,t^a),(t,t^c),(t,t^d),
(t,t^(a*d)),(c^4*t^a)^k,(d*b*t)^g,(d*b*t^a)^m>;
if #G gt 144 then k,g,m, Index(G,sub<G/a,b,c,d,e,f>),
#G; end if; end for;

```

## *Appendix L*

# *MAGMA Code for Monomial Progenitor $3^*5 :_m (2^4 : (2 \times 5))$*

```

S:=Sym(10);
aa:=S! (1, 2)(3, 5)(4, 7)(6, 9)(8, 10);
bb:=S! (1, 3, 6, 10, 7)(2, 4, 8, 9, 5);
cc:=S! (1, 2)(5, 7);
dd:=S! (3, 4)(5, 7);
ee:=S! (1, 2)(3, 4)(5, 7)(6, 8);
ff:=S! (5, 7)(9, 10);
N:=sub<S|aa,bb,cc,dd,ff>;
#N;

CH:=CharacterTable(N);
CH;

S:=Subgroups(N);
for i in [1..#S] do if #S[i]'subgroup eq 32 then i;
end if; end for; H:=S[41]'subgroup;
#H;
ch:=CharacterTable(H);
ch;
I:=Induction(ch[2],N);
I;
IsFaithful(I);
Norm(I);
CH[6] eq I;
T:=Transversal(N,H);
T;

```

```

/* G = He U H(1, 3, 6, 10, 7)(2, 4, 8, 9, 5) U H(1, 6, 7, 3, 10)
      (2, 8, 5, 4, 9) U H(1, 7, 10, 6, 3)(2, 5, 9, 8, 4) U
      H(1, 10, 3, 7, 6)(2, 9, 4, 5, 8)
So there are 5 tis and each one has 3 pows */

```

```

A:= [0: i in [1..25]];
for i in [1..5] do if aa*T[i]^-1 in H then i, ch[2](aa*T[i]^-1);
end if; end for;
for i in [1..5] do if T[2]*aa*T[i]^-1 in H then i,
ch[2](T[2]*aa*T[i]^-1); end if; end for;
for i in [1..5] do if T[3]*aa*T[i]^-1 in H then i,
ch[2](T[3]*aa*T[i]^-1); end if; end for;
for i in [1..5] do if T[4]*aa*T[i]^-1 in H then i,
ch[2](T[4]*aa*T[i]^-1); end if; end for;
for i in [1..5] do if T[5]*aa*T[i]^-1 in H then i,
ch[2](T[5]*aa*T[i]^-1); end if; end for;
A:= [0: i in [1..25]];
A[2]:=1; A[6]:=1; A[14]:=1; A[18]:=1; A[25]:=1;
G:=GL(5,3);
Order(G!A);
aa;

```

```

-----
B:= [0: i in [1..25]];
for i in [1..5] do if bb*T[i]^-1 in H then i,
ch[2](bb*T[i]^-1); end if; end for;
for i in [1..5] do if T[2]*bb*T[i]^-1 in H then i,
ch[2](T[2]*bb*T[i]^-1); end if; end for;
for i in [1..5] do if T[3]*bb*T[i]^-1 in H then i,
ch[2](T[3]*bb*T[i]^-1); end if; end for;
for i in [1..5] do if T[4]*bb*T[i]^-1 in H then i,
ch[2](T[4]*bb*T[i]^-1); end if; end for;
for i in [1..5] do if T[5]*bb*T[i]^-1 in H then i, c
h[2](T[5]*bb*T[i]^-1); end if; end for;
B:= [0: i in [1..25]];
B[2]:=1; B[8]:=1; B[15]:=1; B[16]:=1; B[24]:=1;
G:=GL(5,3);
Order(G!B);
bb;

```

```

-----
C:= [0: i in [1..25]];
for i in [1..5] do if cc*T[i]^-1 in H then i,
ch[2](cc*T[i]^-1); end if; end for;
for i in [1..5] do if T[2]*cc*T[i]^-1 in H then i,

```

```

ch[2](T[2]*cc*T[i]^-1); end if; end for;
for i in [1..5] do if T[3]*cc*T[i]^-1 in H then i,
ch[2](T[3]*cc*T[i]^-1); end if; end for;
for i in [1..5] do if T[4]*cc*T[i]^-1 in H then i,
ch[2](T[4]*cc*T[i]^-1); end if; end for;
for i in [1..5] do if T[5]*cc*T[i]^-1 in H then i,
ch[2](T[5]*cc*T[i]^-1); end if; end for;
C:= [0: i in [1..25]];
C[1]:=1; C[7]:=-1; C[13]:=-1; C[19]:=-1; C[25]:=-1;
G:=GL(5,3);
Order(G!C);
cc;
-----
D:= [0: i in [1..25]];
for i in [1..5] do if dd*T[i]^-1 in H then i,
ch[2](dd*T[i]^-1); end if; end for;
for i in [1..5] do if T[2]*dd*T[i]^-1 in H then i,
ch[2](T[2]*dd*T[i]^-1); end if; end for;
for i in [1..5] do if T[3]*dd*T[i]^-1 in H then i,
ch[2](T[3]*dd*T[i]^-1); end if; end for;
for i in [1..5] do if T[4]*dd*T[i]^-1 in H then i,
ch[2](T[4]*dd*T[i]^-1); end if; end for;
for i in [1..5] do if T[5]*dd*T[i]^-1 in H then i,
ch[2](T[5]*dd*T[i]^-1); end if; end for;
D:= [0: i in [1..25]];
D[1]:=-1; D[7]:=-1; D[13]:=1; D[19]:=1; D[25]:=1;
G:=GL(5,3);
Order(G!D);
dd;
-----
E:= [0: i in [1..25]];
for i in [1..5] do if ee*T[i]^-1 in H then i,
ch[2](ee*T[i]^-1); end if; end for;
for i in [1..5] do if T[2]*ee*T[i]^-1 in H then i,
ch[2](T[2]*ee*T[i]^-1); end if; end for;
for i in [1..5] do if T[3]*ee*T[i]^-1 in H then i,
ch[2](T[3]*ee*T[i]^-1); end if; end for;
for i in [1..5] do if T[4]*ee*T[i]^-1 in H then i,
ch[2](T[4]*ee*T[i]^-1); end if; end for;
for i in [1..5] do if T[5]*ee*T[i]^-1 in H then i,
ch[2](T[5]*ee*T[i]^-1); end if; end for;
E:= [0: i in [1..25]];
E[1]:=-1; E[7]:=1; E[13]:=-1; E[19]:=1; E[25]:=1;
G:=GL(5,3);

```

```

Order(G!E);
ee;
-----
F:= [0: i in [1..25]];
for i in [1..5] do if ff*T[i]^-1 in H then i,
ch[2](ff*T[i]^-1); end if; end for;
for i in [1..5] do if T[2]*ff*T[i]^-1 in H then i,
ch[2](T[2]*ff*T[i]^-1); end if; end for;
for i in [1..5] do if T[3]*ff*T[i]^-1 in H then i,
ch[2](T[3]*ff*T[i]^-1); end if; end for;
for i in [1..5] do if T[4]*ff*T[i]^-1 in H then i,
ch[2](T[4]*ff*T[i]^-1); end if; end for;
for i in [1..5] do if T[5]*ff*T[i]^-1 in H then i,
ch[2](T[5]*ff*T[i]^-1); end if; end for;
F:= [0: i in [1..25]];
F[1]:=-1; F[7]:=-1; F[13]:=-1; F[19]:=1; F[25]:=-1;
G:=GL(5,3);
Order(G!F);
ff;
-----
A;B;C;D;E;F;
M:=sub<G/A,B,C,D,E,F>;
#M;
/* I label the tis by (t1,t2,t3,t4,t5,t1^2,t2^2,t3^2,
t4^2,t5^2, t1^3,t2^3,t3^3,t4^3,t5^3) start with 1 to 15 */

S:=Sym(15);
aa:=S! (1, 2)(3, 4)(6, 7)(8, 9);
bb:=S! (1, 2, 3, 5, 4)(6, 7, 8, 10, 9);
cc:=S! (2, 7)(3, 8)(4, 9)(5, 10);
dd:=S! (1, 6)(2, 7);
ee:=S! (1, 6)(3, 8);
nn:=S! (1, 6)(2, 7)(3, 8)(5, 10);
N:=sub<S/aa,bb,cc,dd,ee,nn>;
G<a,b,c,d,e,n>:=Group<a,b,c,d,e,n/a^2,b^5,c^2,d^2,e^2,
n^2,b^a=b^4,c^a=c*d,c^b=c*d,d^a=d,d^b=d*e,d^c=d,e^a=c*d*n,
e^b=e*n,e^c=e,e^d=e,n^a=c*e,n^b=c,n^c=n,n^d=n,n^e=n>;
#G;
f,G1,k:=CosetAction(G,sub<G/Id(G)>);
s:=IsIsomorphic(G1,N);
s;
s:=IsIsomorphic(M,N);
s;
/* the set stabilizer in S(3) of the set {t1,t1^2}=1,6

```

```

Now continue and write a presentation for
the progenitor  $3^{\{5\}}:N$ .*/
Sch:=SchreierSystem(G,sub<G/Id(G)>);
ArrayP:=[Id(N): i in [1..160]];
for i in [2..160] do
P:=[Id(N): l in [1..#Sch[i]]];
for j in [1..#Sch[i]] do
if Eltseq(Sch[i])[j] eq 1 then P[j]:=aa; end if;
if Eltseq(Sch[i])[j] eq 2 then P[j]:=bb; end if;
if Eltseq(Sch[i])[j] eq -2 then P[j]:=bb^-1; end if;
if Eltseq(Sch[i])[j] eq 3 then P[j]:=cc; end if;
if Eltseq(Sch[i])[j] eq 4 then P[j]:=dd; end if;
if Eltseq(Sch[i])[j] eq 5 then P[j]:=ee; end if;
if Eltseq(Sch[i])[j] eq 6 then P[j]:=nn; end if;
end for;
PP:=Id(N);
for k in [1..#P] do
PP:=PP*P[k]; end for;
ArrayP[i]:=PP;
end for;
for i in [1..160] do Sch[i], ArrayP[i]; end for;
N16:=Stabiliser(N,{1,6});
N16;
/*
Permutation group N16 acting on a set of cardinality 15
Order = 32 = 2^5
(3, 8)(5, 10)
(2, 7)(5, 10)
(4, 9)(5, 10)
(2, 4)(3, 10)(5, 8)(7, 9)
(1, 6)(5, 10)
*/
for i in [1..160] do
if ArrayP[i] eq N!.. then Sch[i]; end if; end for;

/* So the presentation for the monomial
progenitor  $3^{\{5\}}:N$  is giving by */
G<a,b,c,d,e,f,t>:=Group<a,b,c,d,e,f,t|a^2,b^5,c^2,d^2,e^2,
f^2,b^a=b^4,c^a=c*d,c^b=c*d,d^a=d,d^b=d*e,d^c=d,e^a=c*d*f,
e^b=e*f,e^c=e,e^d=e,f^a=c*e,f^b=c,f^c=f,f^d=f,f^e=f,t^3,
t^(c*d*e)=t,t^(d*f)=t,t^(e*f)=t,t^(a*c*(b^-1)*d)=t,
t^(d*e*f)=t^2>;

/* To Verify that your progenitor is correct:*/

```



```

Orbits(Stabiliser(N, {1, 6}));
G<a, b, c, d, e, n, t>:=Group<a, b, c, d, e, n, t/a^2, b^5, c^2, d^2,
e^2, n^2, b^a=b^4, c^a=c*d, c^b=c*d, d^a=d, d^b=d*e, d^c=d,
e^a=c*d*n, e^b=e*n, e^c=e, e^d=e, n^a=c*e, n^b=c, n^c=n,
n^d=n, n^e=n, t^3, t^(c*d*e)=t, t^(d*n)=t, t^(e*n)=t,
t^(a*c*b^-1*d)=t, t^(d*e*n)=t^2, (t, t^a), (t, t^(a*b))>;
#G;
f, G1, k:=CosetAction(G, sub<G/a, b, c, d, e, n>);
#G1;
#k;
IN:=sub<G1/f(a), f(b), f(c), f(d), f(e), f(n)>;
#IN;
T:=sub<G1/f(t)>;
#T;
# Normalizer(IN, T);

```

## Appendix M

# MAGMA Code for Isomorphism Type of $2^8 : \bullet L_2(8)$

```

/* Consider the subgroup G1 of S_8 below.
We will show that N is isomorphic to the mixed extension of
2^8 by L_2(8).*/

S:=Sym(8);
aa:=S! (2, 5)(6, 7);
bb:=S! (1, 2)(3, 7)(4, 5)(6, 8);
cc:=S! (1, 3)(2, 6)(4, 8)(5, 7);
dd:=S! (1, 2)(3, 6)(4, 5)(7, 8);
ee:=S! (1, 4)(2, 5)(3, 8)(6, 7);
N:=sub<S/aa,bb,cc,dd,ee>;
G<a,b,c,d,e,t>:=Group<a,b,c,d,e,t/a^2,b^2,c^2,d^2,e^2,b^a=b*e,
c^a=c,c^b=c*e,d^a=d*e,d^b=d,d^c=d,e^a=e,e^b=e,e^c=e,e^d=e,t^2,
(t,a),(t,b*d),(a*d*e*t)^3,(a*b*c*d*t)^7,(a*c*d*t)^9>;
f,G1,k:=CosetAction(G,sub<G/a,b,c,d,e>);
#G1, #k;
CompositionFactors(G1);
/* We will find the Isomorphism type of G1 = 129024 */
Center(G1);
NL:=NormalLattice(G1);
NL;
/* We will search for the largest Abelian subgroup of G1,
NL[i], using the normal subgroup lattice NL */

for i in [1..11] do if IsAbelian(NL[i]) then i; end if; end for;

```

```

/* Thus, NL[6] is the largest Abelian subgroup of G1.
We factor G1 by NL[6], and call it q.
Since Center(G1) < NL[6], G1 is a mixed extension of NL[6] by
q, the factor group G1/NL[6]. We now find isomorphism types
and presentations of NL[6] and q. */
/* We show below that NL[6] is isomorphic to 2^8 */
NL[6];
m:=AbelianGroup(GrpPerm,[2,2,2,2,2,2,2,2]);
s:=IsIsomorphic(m,NL[6]);
s;
/* true */
/* NL[6]=2^8 is generated by x,y,z,w,u,v,k and r given below. */

NL[6] eq sub<NL[6]|NL[6].1,NL[6].2,NL[6].3,NL[6].4,NL[6].5,
NL[6].6,NL[6].7,NL[6].8>;
x:=G1!NL[6].1;
y:=G1!NL[6].2;
z:=G1!NL[6].3;
w:=G1!NL[6].4;
u:=G1!NL[6].5;
v:=G1!NL[6].6;
k:=G1!NL[6].7;
r:=G1!NL[6].8;
/* A presentation of NL[6] is {x,y,z,w,u,v,k,r|x^2,y^2,
z^2,w^2,u^2,v^2,k^2,r^2,(x,y),(x,z),(x,w),(x,u),(x,v),
(x,k),(x,r),(y,z),(y,w),(y,u),(y,v),(y,k),(y,r),(z,w),
(z,u),(z,v),(z,k),(z,r),(w,u),(w,v),(w,k),(w,r),(u,v),
(u,k),(u,r),(v,k),(v,r),(k,r)}.*/
/* We factor G1 by N[6] and find the generators of q
a presentation for q.*/
H<x,y,z,w,u,v,k,r>:=Group<x,y,z,w,u,v,k,r|x^2,y^2,z^2,
w^2,u^2,v^2,k^2,x^2,y^2,z^2,w^2,u^2,v^2,k^2,r^2,(x,y),
(x,z),(x,w),(x,u),(x,v),(x,k),(x,r),(y,z),(y,w),(y,u),
(y,v),(y,k),(y,r),(z,w),(z,u),(z,v),(z,k),(z,r),(w,u),
(w,v),(w,k),(w,r),(u,v),(u,k),(u,r),(v,k),(v,r),(k,r)>;
#H;
f,H1,k:=CosetAction(H,sub<H|Id(H)>);
s:=IsIsomorphic(H1,NL[6]);
s;
q,ff:=quo<G1|NL[6]>;
q;
q eq sub<q|q.2,q.3,q.6>;
Order(sub<q|q.2,q.3,q.6>);
/* q eq sub<q|q.2,q.3,q.6>;*/

```

```

/* We show below that q is isomorphic to (2^3 x 3^2 x 7).*/
HH<a,b,c>:=Group<a,b,c/a^2,b^2,c^2,(a*b)^2,(a*c)^3,(b*c)^7,
(a*b*c)^9>;
#HH;
f,h2,k:=CosetAction(HH,sub<HH/Id(HH)>);
s:=IsIsomorphic(h2,q);s;
/*true */
IsIsomorphic(PSL(2,8),q);
/* true Homomorphism of GrpPerm: , Degree 9,
Order 2^3 * 3^2 * 7 into GrpPerm: q,
Degree 36, Order 2^3 * 3^2 * 7 induced by
(3, 5, 6, 7, 9, 8, 4) |--> (1, 28, 23, 6, 22, 32, 16)
(2, 34, 18, 11, 7, 29, 15)(3, 24, 14, 36, 12, 30, 20)
(5, 33, 19, 35, 17, 25, 10)(8, 27, 9, 13, 26, 31, 21),
(1, 3, 2)(4, 7, 8)(5, 6, 9) |--> (1, 19, 11)(2, 8, 30)
(3, 29, 9)(4, 12, 13)(5, 6, 18)(7, 34, 33)(10, 27, 36)
(14, 28, 21)(15, 22, 16)(17, 25, 32)(20, 35, 26)
(23, 31, 24) */

/* We now see if the generators and relations of q can be
expressed in terms of nonidentity elements of NL[6]. */
T:=Transversal(G1,NL[6]);
q,ff:=quo<G1/NL[6]>;
ff(T[2]) eq q.2;
ff(T[3]) eq q.3;
ff(T[4]) eq q.6;
A:=T[2];
B:=T[3];
C:=T[4];

ff(A*B) eq q.2*q.3;
ff(A*C) eq q.2*q.6;
ff(B*C) eq q.3*q.6;

Order(A) eq Order(q.2);
Order(B) eq Order(q.3);
Order(C) eq Order(q.6);

Order(A*B) eq Order(q.2*q.3);
Order(A*C) eq Order(q.2*q.6);
Order(B*C) eq Order(q.3*q.6);
/*
Order(A) eq Order(q.2);true
Order(B) eq Order(q.3);true

```

```

Order(C) eq Order(q.6);true
Order(A*B) eq Order(q.2*q.3);false
Order(A*C) eq Order(q.2*q.6);false
Order(B*C) eq Order(q.3*q.6);false */

/* The computation above demonstrates, it is possible.
   Thus G1 is a Semi-direct product of NL[6] by q; that is,
   2^8 by (L_2(8)). Thus G1 is isomorphic to
   (2^8: L_2(8)). */

/* we now determine the action of q on NL[6],
   and using Transversal of NL[6] */
for i,j,l,m,n,o,p,s in [1..2] do if x^A eq x^i*y^j*z^l*
w^m*u^n*v^o*k^p*r^s then i,j,l,m,n,o,p,s; end if; end for;
for i,j,l,m,n,o,p,s in [1..2] do if x^B eq x^i*y^j*z^l*
w^m*u^n*v^o*k^p*r^s then i,j,l,m,n,o,p,s; end if; end for;
for i,j,l,m,n,o,p,s in [1..2] do if x^C eq x^i*y^j*z^l*
w^m*u^n*v^o*k^p*r^s then i,j,l,m,n,o,p,s; end if; end for;

for i,j,l,m,n,o,p,s in [1..2] do if y^A eq x^i*y^j*z^l*
w^m*u^n*v^o*k^p*r^s then i,j,l,m,n,o,p,s; end if; end for;
for i,j,l,m,n,o,p,s in [1..2] do if y^B eq x^i*y^j*z^l*
w^m*u^n*v^o*k^p*r^s then i,j,l,m,n,o,p,s; end if; end for;
for i,j,l,m,n,o,p,s in [1..2] do if y^C eq x^i*y^j*z^l*
w^m*u^n*v^o*k^p*r^s then i,j,l,m,n,o,p,s; end if; end for;

for i,j,l,m,n,o,p,s in [1..2] do if z^A eq x^i*y^j*z^l*
w^m*u^n*v^o*k^p*r^s then i,j,l,m,n,o,p,s; end if; end for;
for i,j,l,m,n,o,p,s in [1..2] do if z^B eq x^i*y^j*z^l*
w^m*u^n*v^o*k^p*r^s then i,j,l,m,n,o,p,s; end if; end for;
for i,j,l,m,n,o,p,s in [1..2] do if z^C eq x^i*y^j*z^l*
w^m*u^n*v^o*k^p*r^s then i,j,l,m,n,o,p,s; end if; end for;

for i,j,l,m,n,o,p,s in [1..2] do if w^A eq x^i*y^j*z^l*
w^m*u^n*v^o*k^p*r^s then i,j,l,m,n,o,p,s; end if; end for;
for i,j,l,m,n,o,p,s in [1..2] do if w^B eq x^i*y^j*z^l*
w^m*u^n*v^o*k^p*r^s then i,j,l,m,n,o,p,s; end if; end for;
for i,j,l,m,n,o,p,s in [1..2] do if w^C eq x^i*y^j*z^l*
w^m*u^n*v^o*k^p*r^s then i,j,l,m,n,o,p,s; end if; end for;

for i,j,l,m,n,o,p,s in [1..2] do if u^A eq x^i*y^j*z^l*
w^m*u^n*v^o*k^p*r^s then i,j,l,m,n,o,p,s; end if; end for;
for i,j,l,m,n,o,p,s in [1..2] do if u^B eq x^i*y^j*z^l*
w^m*u^n*v^o*k^p*r^s then i,j,l,m,n,o,p,s; end if; end for;

```

for  $i, j, l, m, n, o, p, s$  in  $[1..2]$  do if  $u^C$  eq  $x^i y^j z^l w^m u^n v^o k^p r^s$  then  $i, j, l, m, n, o, p, s$ ; end if; end for;

for  $i, j, l, m, n, o, p, s$  in  $[1..2]$  do if  $v^A$  eq  $x^i y^j z^l w^m u^n v^o k^p r^s$  then  $i, j, l, m, n, o, p, s$ ; end if; end for;  
 for  $i, j, l, m, n, o, p, s$  in  $[1..2]$  do if  $v^B$  eq  $x^i y^j z^l w^m u^n v^o k^p r^s$  then  $i, j, l, m, n, o, p, s$ ; end if; end for;  
 for  $i, j, l, m, n, o, p, s$  in  $[1..2]$  do if  $v^C$  eq  $x^i y^j z^l w^m u^n v^o k^p r^s$  then  $i, j, l, m, n, o, p, s$ ; end if; end for;

for  $i, j, l, m, n, o, p, s$  in  $[1..2]$  do if  $k^A$  eq  $x^i y^j z^l w^m u^n v^o k^p r^s$  then  $i, j, l, m, n, o, p, s$ ; end if; end for;  
 for  $i, j, l, m, n, o, p, s$  in  $[1..2]$  do if  $k^B$  eq  $x^i y^j z^l w^m u^n v^o k^p r^s$  then  $i, j, l, m, n, o, p, s$ ; end if; end for;  
 for  $i, j, l, m, n, o, p, s$  in  $[1..2]$  do if  $k^C$  eq  $x^i y^j z^l w^m u^n v^o k^p r^s$  then  $i, j, l, m, n, o, p, s$ ; end if; end for;

for  $i, j, l, m, n, o, p, s$  in  $[1..2]$  do if  $r^A$  eq  $x^i y^j z^l w^m u^n v^o k^p r^s$  then  $i, j, l, m, n, o, p, s$ ; end if; end for;  
 for  $i, j, l, m, n, o, p, s$  in  $[1..2]$  do if  $r^B$  eq  $x^i y^j z^l w^m u^n v^o k^p r^s$  then  $i, j, l, m, n, o, p, s$ ; end if; end for;  
 for  $i, j, l, m, n, o, p, s$  in  $[1..2]$  do if  $r^C$  eq  $x^i y^j z^l w^m u^n v^o k^p r^s$  then  $i, j, l, m, n, o, p, s$ ; end if; end for;

for  $i, j, l, m, n, o, p, s$  in  $[1..2]$  do if  $A^2$  eq  $x^i y^j z^l w^m u^n v^o k^p r^s$  then  $i, j, l, m, n, o, p, s$ ; end if; end for;  
 for  $i, j, l, m, n, o, p, s$  in  $[1..2]$  do if  $B^2$  eq  $x^i y^j z^l w^m u^n v^o k^p r^s$  then  $i, j, l, m, n, o, p, s$ ; end if; end for;  
 for  $i, j, l, m, n, o, p, s$  in  $[1..2]$  do if  $C^2$  eq  $x^i y^j z^l w^m u^n v^o k^p r^s$  then  $i, j, l, m, n, o, p, s$ ; end if; end for;

for  $i, j, l, m, n, o, p, s$  in  $[1..2]$  do if  $(A*B)^2$  eq  $x^i y^j z^l w^m u^n v^o k^p r^s$  then  $i, j, l, m, n, o, p, s$ ; end if; end for;  
 for  $i, j, l, m, n, o, p, s$  in  $[1..2]$  do if  $(A*C)^3$  eq  $x^i y^j z^l w^m u^n v^o k^p r^s$  then  $i, j, l, m, n, o, p, s$ ; end if; end for;  
 for  $i, j, l, m, n, o, p, s$  in  $[1..2]$  do if  $(B*C)^7$  eq  $x^i y^j z^l w^m u^n v^o k^p r^s$  then  $i, j, l, m, n, o, p, s$ ; end if; end for;  
 for  $i, j, l, m, n, o, p, s$  in  $[1..2]$  do if  $(A*B*C)^9$  eq  $x^i y^j z^l w^m u^n v^o k^p r^s$  then  $i, j, l, m, n, o, p, s$ ; end if; end for;  
 $x^A$  eq  $x*w$ ;  
 $x^B$  eq  $x$ ;  
 $x^C$  eq  $x$ ;  
 $y^A$  eq  $y$ ;  
 $y^B$  eq  $y*w$ ;

```

y^C eq y;
z^A eq z*r;
z^B eq z*w*r;
z^C eq z;
w^A eq w;
w^B eq w;
w^C eq z*u;
u^A eq w*u*r;
u^B eq w*u*v*r;
u^C eq z*w;
v^A eq v;
v^B eq v;
v^C eq k;
k^A eq v*k;
k^B eq k*r;
k^C eq v;
r^A eq r;
r^B eq r;
r^C eq z*r;
/* Here is a presentation for the mixed extension of 2^8 by
L_2(8). */
M<x,y,z,w,u,v,k,r,a,b,c>:=Group<x,y,z,w,u,v,k,r,a,b,c/x^2,y^2,
z^2,w^2,u^2,v^2,k^2,r^2,(x,y),(x,z),(x,w),(x,u),(x,v),(x,k),
(x,r),(y,z),(y,w),(y,u),(y,v),(y,k),(y,r),(z,w),(z,u),(z,v),
(z,k),(z,r),(w,u),(w,v),(w,k),(w,r),(u,v),(u,k),(u,r),(v,k),
(v,r),(k,r),a^2,b^2,c^2,(a*b)^2=w,(a*c)^3=x*y*z*w*u,
(b*c)^7=x*y*z*v*k,(a*b*c)^9=x*y,x^a=x*w,x^b=x,x^c=x,
y^a=y,y^b=y*w,y^c=y,z^a=z*r,z^b=z*w*r,z^c=z,
w^a=w,w^b=w,w^c=z*u,u^a=w*u*r,u^b=w*u*v*r,u^c=z*w,
v^a=v,v^b=v,v^c=k,k^a=v*k,k^b=k*r,k^c=v,
r^a=r,r^b=r,r^c=z*r>;
#M;
f1,M1,k1:=CosetAction(M,sub<M/Id(M)>);
s:=IsIsomorphic(M1,G1);
s;
/*true */
/* G isomorphic to the mixed extension of 2^8 by L_2(8)*/

```

## Appendix N

### MAGMA Code for Isomorphism

#### Type of $2^7 : \bullet A_5$

```

/* Consider the subgroup G1 of S_8 below.
We will show that N is isomorphic to the mixed extension of
2^7 by A_5.*/

S:=Sym(8);
aa:=S! (2, 5)(6, 7);
bb:=S! (1, 2)(3, 7)(4, 5)(6, 8);
cc:=S! (1, 3)(2, 6)(4, 8)(5, 7);
dd:=S! (1, 2)(3, 6)(4, 5)(7, 8);
ee:=S! (1, 4)(2, 5)(3, 8)(6, 7);
N:=sub<S/aa,bb,cc,dd,ee>;
G<a,b,c,d,e,t>:=Group<a,b,c,d,e,t/a^2,b^2,c^2,d^2,e^2,
b^a=b*e,c^a=c,c^b=c*e,d^a=d*e,d^b=d,d^c=d,e^a=e,e^b=e,
e^c=e,e^d=e,t^2,(t,a),(t,b*d),(a*d*e*t)^3,(a*b*c*d*t)^5,
(a*c*d*t)^10>;
#G;
f,G1,k:=CosetAction(G,sub<G/a,b,c,d,e>);
#G1, #k;
/* We will find the Isomorphism type of G1 = 7680 */
Center(G1);
CompositionFactors(G1);
NL:=NormalLattice(G1);
NL;
/* We will search for the largest Abelian subgroup of G1,
NL[i], using the normal subgroup lattice NL */

```



```

for i in [1..34] do if IsAbelian(NL[i]) then i; end if; end for;

/* Thus, NL[18] is the largest Abelian subgroup of G1. We factor G1
by NL[18], and call it q. Since Center(G1) < NL[18], G1 is a
mixed extension of NL[18] by q, the factor group G1/NL[18].
We now find isomorphism types and presentations of NL[18] and q. */
/* We show below that NL[18] is isomorphic to 2^7 */
NL[18];
m:=AbelianGroup(GrpPerm, [2,2,2,2,2,2,2]);
IsIsomorphic(m, NL[18]);
/* true Mapping from: GrpPerm: m to GrpPerm: Degree 240,
Order 2^7 Composition of Mapping from: GrpPerm: m to GrpPC
and Mapping from: GrpPC to GrpPC and
Mapping from: GrpPC to GrpPerm: , Degree 240, Order 2^7
*/
/* NL[18] is generated by x,y,z,w,u,v and k given below. */

NL[18] eq sub<NL[18]|NL[18].1,NL[18].2,NL[18].3,
NL[18].4,NL[18].5,NL[18].6,NL[18].7>;
x:=G1!NL[18].1;
y:=G1!NL[18].2;
z:=G1!NL[18].3;
w:=G1!NL[18].4;
u:=G1!NL[18].5;
v:=G1!NL[18].6;
k:=G1!NL[18].7;
x*y eq y*x;
/* A presentation of NL[18] is {x,y,z,w,u,v,k|x^2,y^2,z^2,w^2,
u^2,v^2,k^2,(x,y),(x,z),(x,w),(x,u),(x,v),(x,k),(y,z),(y,w),
(y,u),(y,v),(y,k),(z,w),(z,u),(z,v),(z,k),(w,u),(w,v),(w,k),
(u,v),(u,k),(v,k)}.*/
/* We factor G1 by N[18] and find the generators of q a
presentation for q.*/
H<x,y,z,w,u,v,k>:=Group<x,y,z,w,u,v,k|x^2,y^2,z^2,w^2,u^2,v^2,
k^2,(x,y),(x,z),(x,w),(x,u),(x,v),(x,k),(y,z),(y,w),(y,u),(y,v),
(y,k),(z,w),(z,u),(z,v),(z,k),(w,u),(w,v),(w,k),(u,v),(u,k),
(v,k)>;#H;

q,ff:=quo<G1|NL[18]>;
q;
q eq sub<q|q.2,q.3,q.6>;
Order( sub<q|q.2,q.3,q.6>);
/* q eq sub<q|q.2,q.3,q.6>; */
/* We show below that q is isomorphic to (2^2 x 3 x 5).*/

```

```

HH<a,b,c>:=Group<a,b,c/a^2,b^2,c^2,(a*b)^2,(a*c)^3,
(b*c)^5,(a*b*c)^5>;
#HH;
f,h2,k:=CosetAction(HH,sub<HH/Id(HH)>);
IsIsomorphic(h2,q);
IsIsomorphic(h2,Alt(5));

/* We now see if the generators and relations of q
can be expressed in terms of nonidentity elements
of NL[18]. */

T:=Transversal(G1,NL[18]);
q,ff:=quo<G1/NL[18]>;
ff(T[2]) eq q.2;
ff(T[3]) eq q.3;
ff(T[4]) eq q.6;

A:=G1!T[2];
B:=G1!T[3];
C:=G1!T[4];

ff(A*B) eq q.2*q.3;
ff(A*C) eq q.2*q.6;
ff(B*C) eq q.3*q.6;

Order(A) eq Order(q.2);
Order(B) eq Order(q.3);
Order(C) eq Order(q.6);
Order(A*B) eq Order(q.2*q.3);
Order(A*C) eq Order(q.2*q.6);
Order(B*C) eq Order(q.3*q.6);
/*
Order(A) eq Order(q.2);true
Order(B) eq Order(q.3);true
Order(C) eq Order(q.6);true
Order(A*B) eq Order(q.2*q.3);false
Order(A*C) eq Order(q.2*q.6);false
Order(B*C) eq Order(q.3*q.6);false */
/* The computation above demonstrates, it is possible.
Thus G1 is a mixed extension product of NL[18] by q;
that is, 2^7 by A_5. Thus G1 is isomorphic
to (2^7:(A_5)). */

/* we now determine the action of q on NL[18],

```

and using Transversal of NL[18] instead of  
the elements of  $q$  and write the generatr elements  
of  $(A_5)$  in terms of  $2^7$ . \*/

```

for i,j,l,m,n,o,p in [1..2] do if x^A eq x^i*y^j*z^l*
*w^m*u^n*v^o*k^p then i,j,l,m,n,o,p; end if; end for;
for i,j,l,m,n,o,p in [1..2] do if x^B eq x^i*y^j*z^l*
w^m*u^n*v^o*k^p then i,j,l,m,n,o,p; end if; end for;
for i,j,l,m,n,o,p in [1..2] do if x^C eq x^i*y^j*z^l*
w^m*u^n*v^o*k^p then i,j,l,m,n,o,p; end if; end for;
for i,j,l,m,n,o,p in [1..2] do if y^A eq x^i*y^j*z^l*
w^m*u^n*v^o*k^p then i,j,l,m,n,o,p; end if; end for;
for i,j,l,m,n,o,p in [1..2] do if y^B eq x^i*y^j*z^l*
w^m*u^n*v^o*k^p then i,j,l,m,n,o,p; end if; end for;
for i,j,l,m,n,o,p in [1..2] do if y^C eq x^i*y^j*z^l*
w^m*u^n*v^o*k^p then i,j,l,m,n,o,p; end if; end for;
for i,j,l,m,n,o,p in [1..2] do if z^A eq x^i*y^j*z^l*
w^m*u^n*v^o*k^p then i,j,l,m,n,o,p; end if; end for;
for i,j,l,m,n,o,p in [1..2] do if z^B eq x^i*y^j*z^l*
w^m*u^n*v^o*k^p then i,j,l,m,n,o,p; end if; end for;
for i,j,l,m,n,o,p in [1..2] do if z^C eq x^i*y^j*z^l*
w^m*u^n*v^o*k^p then i,j,l,m,n,o,p; end if; end for;
for i,j,l,m,n,o,p in [1..2] do if w^A eq x^i*y^j*z^l*
w^m*u^n*v^o*k^p then i,j,l,m,n,o,p; end if; end for;
for i,j,l,m,n,o,p in [1..2] do if w^B eq x^i*y^j*z^l*
w^m*u^n*v^o*k^p then i,j,l,m,n,o,p; end if; end for;
for i,j,l,m,n,o,p in [1..2] do if w^C eq x^i*y^j*z^l*
w^m*u^n*v^o*k^p then i,j,l,m,n,o,p; end if; end for;
for i,j,l,m,n,o,p in [1..2] do if u^A eq x^i*y^j*z^l*
w^m*u^n*v^o*k^p then i,j,l,m,n,o,p; end if; end for;
for i,j,l,m,n,o,p in [1..2] do if u^B eq x^i*y^j*z^l*
w^m*u^n*v^o*k^p then i,j,l,m,n,o,p; end if; end for;
for i,j,l,m,n,o,p in [1..2] do if u^C eq x^i*y^j*z^l*
w^m*u^n*v^o*k^p then i,j,l,m,n,o,p; end if; end for;
for i,j,l,m,n,o,p in [1..2] do if v^A eq x^i*y^j*z^l*
w^m*u^n*v^o*k^p then i,j,l,m,n,o,p; end if; end for;
for i,j,l,m,n,o,p in [1..2] do if v^B eq x^i*y^j*z^l*
w^m*u^n*v^o*k^p then i,j,l,m,n,o,p; end if; end for;
for i,j,l,m,n,o,p in [1..2] do if v^C eq x^i*y^j*z^l*
w^m*u^n*v^o*k^p then i,j,l,m,n,o,p; end if; end for;
for i,j,l,m,n,o,p in [1..2] do if k^A eq x^i*y^j*z^l*
w^m*u^n*v^o*k^p then i,j,l,m,n,o,p; end if; end for;
for i,j,l,m,n,o,p in [1..2] do if k^B eq x^i*y^j*z^l*
w^m*u^n*v^o*k^p then i,j,l,m,n,o,p; end if; end for;

```

```

for i,j,l,m,n,o,p in [1..2] do if k^C eq x^i*y^j*z^l*
w^m*u^n*v^o*k^p then i,j,l,m,n,o,p; end if; end for;

for i,j,l,m,n,o,p in [1..2] do if (A*B)^2 eq x^i*y^j*
z^l*w^m*u^n*v^o*k^p then i,j,l,m,n,o,p; end if; end for;
for i,j,l,m,n,o,p in [1..2] do if (A*C)^3 eq x^i*y^j*
z^l*w^m*u^n*v^o*k^p then i,j,l,m,n,o,p; end if; end for;
for i,j,l,m,n,o,p in [1..2] do if (B*C)^5 eq x^i*y^j*
z^l*w^m*u^n*v^o*k^p then i,j,l,m,n,o,p; end if; end for;
for i,j,l,m,n,o,p in [1..2] do if (A*B*C)^5 eq x^i*y^j*
z^l*w^m*u^n*v^o*k^p then i,j,l,m,n,o,p; end if; end for;

x^A eq x;
x^B eq x*w;
x^C eq x;
y^A eq y;
y^B eq y;
y^C eq y;
z^A eq z;
z^B eq z;
z^C eq v;
w^A eq w;
w^B eq w;
w^C eq z*u;
u^A eq w*u;
u^B eq z*u;
u^C eq w*v;
v^A eq z*v;
v^B eq z*w*v;
v^C eq z;
k^A eq w*k;
k^B eq k;
k^C eq k;
/* Here is a presentation for the mixed extension of
2^7 by A_ (5). */

G<x,y,z,w,u,v,k,a,b,c>:=Group<x,y,z,w,u,v,k,a,b,c/x^2,y^2,
z^2,w^2,u^2,v^2,k^2,(x,y),(x,z),(x,w),(x,u),(x,v),(x,k),
(y,z),(y,w),(y,u),(y,v),(y,k),(z,w),(z,u),(z,v),(z,k),(w,u)
,(w,v),(w,k),(u,v),(u,k),(v,k),a^2,b^2,c^2,(a*b)^2=w,
(a*c)^3=x*z*w*u*k,(b*c)^5=x*w*u*v*k,(a*b*c)^5=y,x^a=x,
x^b=x*w,x^c=x,y^a=y,y^b=y,y^c=y,z^a=z,z^b=z,z^c=v,w^a=w,
w^b=w,w^c=z*u,u^a=w*u,u^b=z*u,u^c=w*v,v^a=z*v,v^b=z*w*v,
v^c=z,k^a=w*k,k^b=k,k^c=k>;

```

```

#G;
/* now we show that G1 is isomorphic to the mixed extension of
2~7 by A_5 given above. */
f1,g1,k1:=CosetAction(G,sub<G/Id(G)>);
IsIsomorphic(g1,G1);
/*true Mapping from: GrpPerm: g1 to GrpPerm: G1
Composition of Mapping from: GrpPerm: g1 to GrpPC and
Mapping from: GrpPC to GrpPC and
Mapping from: GrpPC to GrpPerm: G1*/

/* Thus, G1 is isomorphic (2~7 :. Alt(5) */

```

## Appendix O

### MAGMA Code for Isomorphism

#### Type of 3 : $(PSL(2, 19) \times 2)$

*/\* Consider the subgroup G1 of S\_8 below. We will show that N is isomorphic to the Semidirect Product of 3 by  $(PSL(2, 19) \times 2)$ .\*/*

```
S:=Sym(8);
aa:=S! (2, 5)(6, 7);
bb:=S! (1, 2)(3, 7)(4, 5)(6, 8);
cc:=S! (1, 3)(2, 6)(4, 8)(5, 7);
dd:=S! (1, 2)(3, 6)(4, 5)(7, 8);
ee:=S! (1, 4)(2, 5)(3, 8)(6, 7);
N:=sub<S/aa,bb,cc,dd,ee>;
G<a,b,c,d,e,t>:=Group<a,b,c,d,e,t/a^2,b^2,c^2,d^2,e^2,
b^a=b*e,c^a=c,c^b=c*e,d^a=d*e,d^b=d,d^c=d,e^a=e,e^b=e,
e^c=e,e^d=e,t^2,(t,a),(t,b*d),(b*c*t)^9,(b*c*d*t)^9,
(a*d*e*t)^10,(a*b*c*d*t)^3,(a*c*d*t)^9>;
f,G1,k:=CosetAction(G,sub<G/a,b,c,d,e>);
#G1, #k;
/* We will find the Isomorphism type of G1 = 20520 */
Center(G1);
CompositionFactors(G1);
NL:=NormalLattice(G1);
NL;
/* We will search for the largest Abelian subgroup of G1,
NL[i], using the normal subgroup lattice NL */
for i in [1..6] do if IsAbelian(NL[i]) then i; end if; end for;

/* Thus, NL[2] is the largest Abelian subgroup of G1.
```



```
#G;  
f1,g1,k1:=CosetAction(G,sub<G/Id(G)>);  
IsIsomorphic(g1,G1);  
  
/* Thus, G1 is isomorphic (3 : (PSL(2,19) x 2) */
```



## Appendix P

### MAGMA Code for Isomorphism

#### Type of $2^3 : \bullet(L_3(4) \times 2)$

```

/* Consider the subgroup G1 of S_9 below. We will show that N
   is isomorphic to the mixed extension of 2^3 by (L_3(4) x 2).*/
S:=Sym(9);
aa:=S!(2, 3, 4, 8, 5, 7, 9, 6);
bb:=S!(2, 4)(3, 7)(5, 9);
cc:=S!(2, 4, 5, 9)(3, 8, 7, 6);
dd:=S!(2, 5)(3, 7)(4, 9)(6, 8);
ee:=S!(1, 2, 5)(3, 6, 9)(4, 8, 7);
ff:=S!(1, 3, 7)(2, 6, 4)(5, 9, 8);
N:=sub<S/aa,bb,cc,dd,ee,ff>;
G<a,b,c,d,e,f,t>:=Group<a,b,c,d,e,f,t/a^8,b^2,
c^4,d^2,e^3,f^3,(e,f),a^2=c,c^2=d,b^a=b*c*d,c^a=c,
c^b=c*d,d^a=d,d^b=d,d^c=d,e^a=f,e^b=e*(f^2),
e^c=e*(f^2),e^d=e^2,f^a=e*(f^2),f^b=f^2,f^c=(e^2)*(f^2)
,f^d=f^2,f^e=f,t^2,(t,a),(t,b),(t,c),(t,d),(a*d*t^e)^6>;
f,G1,k:=CosetAction(G,sub<G/a,b,c,d,e,f>);
#G1; #k;
/* We will find the Isomorphism type of G1 = 645120 */
Center(G1);
CompositionFactors(G1);
NL:=NormalLattice(G1);
NL;
/* We will search for the largest Abelian subgroup of G1,
NL[i], using the normal subgroup lattice NL */

for i in [1..25] do if IsAbelian(NL[i]) then i; end if;

```

```

end for;
/* Thus, NL[8] is the largest Abelian subgroup of G1.
We factor G1 by NL[8], and call it q. Since Center(G1) < NL[8],
G1 is a mixed extension of NL[8] by q, the factor group G1/NL[8].
We now find isomorphism types and presentations of NL[8] and q. */
/* We show below that NL[8] is isomorphic to 2^3 */
NL[8];
m:=AbelianGroup(GrpPerm,[8]);
IsIsomorphic(m,NL[8]);

/* NL[8] is generated by x and k given below. */
NL[8] eq sub<NL[8]|NL[8].1>;
x:=NL[8].1;

x:=G1!NL[8].1;
/* A presentation of NL[8]{x|x^8} */
/* We factor G1 by N[8] and find the generators
of q a presentation for q.*/
q,ff:=quo<G1|NL[8]>;
q;
q eq sub<q|q.1,q.2,q.3,q.4,q.5,q.6,q.7>;
Order( sub<q|q.1,q.2,q.3,q.4,q.5,q.6,q.7>);
D:=DirectProduct(PSL(3,4),CyclicGroup(2));
IsIsomorphic(D,q);
FPGroup(q);
/* q eq sub<q|q.1,q.2,q.3,q.4,q.5,q.6,q.7>; */
/* We show below that q is isomorphic to (L_3(4) X 2).*/

H<a,b,c,d,e,f,z>:=Group<a,b,c,d,e,f,z|a^8,b^2,c^4,d^2,
e^3,f^3,z^2,(a^-2*c),(c*a^2*d),(b*c^-1)^2,(a^-1*e^-1*a*f)
,(d*e^-1)^2,(b*f^-1)^2,(e,f),(a^-1*z*a*z),(b*f)^2,
(a^-1*b*a^-1*b*d),(a*e^-1*a^-1*e*f),(e*z*e^-1*z*e^-1*z
*b^2*d*e^-1*z*e^-1*z*e*z),(z*e^-1*z*c^-1*f*z*e*c*z*f*z
*e*c^-1*z*f^-1),(z*b*f^-1*e^-1*z*f*z*e^-1*c*z*e*z*f*a*z*e)>;
#H;
f,h1,k:=CosetAction(H,sub<H|Id(H)>);
IsIsomorphic(h1,q);
/*true Mapping from: GrpPerm: h1 to GrpPerm: q
Composition of Mapping from: GrpPerm: h1 to GrpPC and
Mapping from: GrpPC to GrpPC and
Mapping from: GrpPC to GrpPerm: q */

/* We now see if the generators and relations
of q can be expressed in terms of nonidentity

```

```

elements of NL[8]. */
T:=Transversal(G1,NL[8]);
q,ff:=quo<G1/NL[8]>;
ff(T[2]) eq q.1;
ff(T[3]) eq q.2;
ff(T[4]) eq q.3;
ff(T[5]) eq q.4;
ff(T[6]) eq q.5;
ff(T[7]) eq q.6;
ff(T[8]) eq q.7;

A:=T[2];
B:=T[3];
C:=T[4];
D:=T[5];
E:=T[6];
F:=T[7];
Z:=T[8];
ff(A*B) eq q.1*q.2;
ff(A*C) eq q.1*q.3;
ff(A*D) eq q.1*q.4;
ff(A*E) eq q.1*q.5;
ff(A*F) eq q.1*q.6;
ff(A*Z) eq q.1*q.7;
Order(A) eq Order(q.1);
Order(B) eq Order(q.2);
Order(C) eq Order(q.3);
Order(D) eq Order(q.4);
Order(E) eq Order(q.5);
Order(F) eq Order(q.6);
Order(Z) eq Order(q.7);
Order(A*B) eq Order(q.1*q.2);
Order(A*C) eq Order(q.1*q.3);
Order(A*D) eq Order(q.1*q.4);
Order(A*E) eq Order(q.1*q.5);
Order(A*F) eq Order(q.1*q.6);
Order(A*Z) eq Order(q.1*q.7);
/* The computation above demonstrates, it is possible.
   Thus G1 is a mixed extension product of NL[8] by q;
   that is,  $2^3$  by  $(L_3(4) \times 2)$ . Thus G1 is isomorphic
   to  $(2^3 : (L_3(4) \times 2))$ . */
A:=G1!T[2];
B:=G1!T[3];
C:=G1!T[4];

```

```

D:=G1!T[5];
E:=G1!T[6];
F:=G1!T[7];
Z:=G1!T[8];
/* we now determine the action of q on NL[8],
and using Transversal of NL[8] instead of the elements
of q and write the generatrs elements of ((L_3(4) X 2))
in terms of 2^3. */

for i in [1..8] do if x^A eq x^i then i; end if; end for;
for i in [1..8] do if x^B eq x^i then i; end if; end for;
for i in [1..8] do if x^C eq x^i then i; end if; end for;
for i in [1..8] do if x^D eq x^i then i; end if; end for;
for i in [1..8] do if x^E eq x^i then i; end if; end for;
for i in [1..8] do if x^F eq x^i then i; end if; end for;
for i in [1..8] do if x^Z eq x^i then i; end if; end for;

for i in [1..8] do if (A^-2*C) eq x^i then i; end if; end for;
for i in [1..8] do if (C*A^2*D) eq x^i then i; end if; end for;
for i in [1..8] do if (B*C^-1)^2 eq x^i then i; end if; end for;
for i in [1..8] do if (A^-1*E^-1*A*F) eq x^i then i; end if;
end for;
for i in [1..8] do if (D*E^-1)^2 eq x^i then i; end if; end for;
for i in [1..8] do if (B*F^-1)^2 eq x^i then i; end if; end for;
for i in [1..8] do if (E,F) eq x^i then i; end if; end for;
for i in [1..8] do if (A^-1*Z*A*Z) eq x^i then i; end if;
end for;
for i in [1..8] do if (B*F)^2 eq x^i then i; end if; end for;
for i in [1..8] do if (A^-1*B*A^-1*B*D) eq x^i then i; end if;
end for;
for i in [1..8] do if (A*E^-1*A^-1*E*F) eq x^i then i; end if;
end for;
for i in [1..8] do if (E*Z*E^-1*Z*E^-1*Z*B^2*D*E^-1*Z*E^-1*Z*E*Z)
eq x^i then i; end if; end for;
for i in [1..8] do if (Z*E^-1*Z*C^-1*F*Z*E*C*Z*F*Z*E*C^-1*Z*F^-1)
eq x^i then i; end if; end for;
for i in [1..8] do if (Z*B*F^-1*E^-1*Z*F*Z*E^-1*C*Z*E*Z*F*A*Z*E)
eq x^i then i; end if; end for;

/* Here is a presentation for the mixed extension of 2^3
by ((L_3(4) X 2)). */
G<x,a,b,c,d,e,f,z>:=Group<x,a,b,c,d,e,f,z/x^8,a^8,b^2,c^4,d^2,
e^3,f^3,z^2,(a^-2*c),(c*a^2*d),(b*c^-1)^2,(a^-1*e^-1*a*f),
(d*e^-1)^2,(b*f^-1)^2,(e,f),(a^-1*z*a*z),(b*f)^2,(a^-1*b*a^-1*b*d)

```

```
, (a*e^-1*a^-1*e*f), (e*z*e^-1*z*e^-1*z*b^2*d*e^-1*z*e^-1*z*e*z)
, (z*e^-1*z*c^-1*f*z*e*c*z*f*z*e*c^-1*z*f^-1),
(z*b*f^-1*e^-1*z*f*z*e^-1*c*z*e*z*f*a*z*e)=x, x^a=x^3, x^b=x^3,
x^c=x, x^d=x, x^e=x, x^f=x, x^z=x^5>;
#G;
```

```
/* now we show that G1 is isomorphic to the mixed extension
of 2^3 by (L_3(4) X 2) given above. */
```

```
f1,g1,k1:=CosetAction(G,sub<G/Id(G)>);
IsIsomorphic(g1,G1);
/* Thus, G1 is isomorphic (2^3 :. (L_3(4) x 2)) */
```

## Appendix Q

# MAGMA Code for Isomorphism Type of $2^2 : M_{12}$

```

/* Consider the subgroup G1 of S_6 below. We will show that N
   is isomorphic to the Semidirect Product of 2^2 by M_12 */
S1:=Sym(6);
ff:=S1!(1, 2)(3, 5)(4, 6);
gg:=S1!(1, 2)(3, 4)(5, 6);
hh:=S1!(1, 3, 6)(2, 4, 5);
H:=sub<S1|ff,gg,hh>;
G<a,b,c,t>:=Group<a,b,c,t/a^2,b^2,c^3,(a*b)^2,(a*c^-1)^2,
(b*(c^-1)*b*c),t^2,(t,a*b),(a*t^c)^5,(a*b*t^c)^6,(c*t)^8,
(b*c*t^b*c)^8>;
f,G1,k:=CosetAction(G,sub<G/a,b,c>);
#G1, #k;
/* We will find the Isomorphism type of G1 = 380160 */
Center(G1);
CompositionFactors(G1);
NL:=NormalLattice(G1);
NL;

/* We will search for the largest Abelian subgroup of G1,
NL[i], using the normal subgroup lattice NL */

for i in [1..10] do if IsAbelian(NL[i]) then i; end if;
end for;
/* Thus, NL[5] is the largest Abelian subgroup of G1.
We factor G1 by NL[5], and call it q. Since
Center(G1) < NL[5], G1 is a mixed extension of NL[5] by

```

```

q, the factor group G1/NL[5]. We now find isomorphism types
and presentations of NL[5] and q. */
/* We show below that NL[5] is isomorphic to 2^2 */
NL[5];
m:=AbelianGroup(GrpPerm,[2,2]);
IsIsomorphic(m,NL[5]);

/* NL[5] is generated by x and y given below. */
NL[5] eq sub<NL[5]|NL[5].2,NL[5].3>;
x:=NL[5].2;
y:=NL[5].3;
x*y eq y*x;
x*y;

/* A presentation of NL[5] is {x,y|x^2,y^2,(x,y)}.*/
/* We factor G1 by N[5] and find the generators of
q a presentation for q.*/
q,ff:=quo<G1|NL[5]>;
q;
q eq sub<q|q.1,q.2,q.3,q.4>;
Order( sub<q|q.1,q.2,q.3,q.4>);
IsIsomorphic(MathieuGroup(12),q);

/* We show below that q is isomorphic to (M12).*/

HH<a,b,c,d>:=Group<a,b,c,d/a^2,b^2,c^3,d^2,(a*b)^2,
(a*c^-1)^2,(a*d)^6,(b*c^-1*b*c),(a*d*b)^2,(c^-1*d*c*d)^3,
(c^-1*a*d*c^-1*a*d*c^-1*a*d*a*c*d*a*c*d),(c^-1*d)^8,
(d*a*d*c^-1*d*a*d*a*d*c*d*a*d*a*d*c^-1*d*b),
(d*a*d*c*d*c^-1*d*a*d*c^-1*d*c*d*b*d*c^-1*d*c),
(a*d*c*d*a*d*c^-1*d*a*d*c*d*a*d*c^-1*d*b*d*c^-1*d)>;
#HH;
f,h2,k:=CosetAction(HH,sub<HH|Id(HH)>);
IsIsomorphic(h2,q);
/*true Mapping from: GrpPerm: h2 to GrpPerm: q
Composition of Mapping from: GrpPerm: h2 to GrpPC and
Mapping from: GrpPC to GrpPC and
Mapping from: GrpPC to GrpPerm: q
*/

/* We now see if the generators and relations of q
can be expressed in terms of nonidentity elements of NL[6]. */
T:=Transversal(G1,NL[5]);
q,ff:=quo<G1|NL[5]>;

```

```

ff(T[2]) eq q.1;
ff(T[3]) eq q.2;
ff(T[4]) eq q.3;
ff(T[5]) eq q.4;
A:=T[2];
B:=T[3];
C:=T[4];
D:=T[5];
/* The computation above demonstrates, it is possible.
Thus G1 is a mixed extension product of NL[5] by q;
that is,  $2^2$  by  $(M(12))$ . Thus G1 is isomorphic to
 $(2^2 : (M(12)))$ . */
/* we now determine the action of q on NL[5], and using
Transversal of NL[5] instead of the elements of q and
write the generatrs elements of  $(M(12))$  in terms of  $2^2$ . */

for i,j in [1..2] do if x^A eq x^i*y^j then i,j; end if; end for;
for i,j in [1..2] do if x^B eq x^i*y^j then i,j; end if; end for;
for i,j in [1..2] do if x^C eq x^i*y^j then i,j; end if; end for;
for i,j in [1..2] do if x^D eq x^i*y^j then i,j; end if; end for;

for i,j in [1..2] do if y^A eq x^i*y^j then i,j; end if; end for;
for i,j in [1..2] do if y^B eq x^i*y^j then i,j; end if; end for;
for i,j in [1..2] do if y^C eq x^i*y^j then i,j; end if; end for;
for i,j in [1..2] do if y^D eq x^i*y^j then i,j; end if; end for;

/* Here is a presentation for the mixed extension
of  $2^2$  by  $(M(12))$ . */
G<x,y,a,b,c,d>:=Group<x,y,a,b,c,d/x^2,y^2,(x,y),
a^2,b^2,c^3,d^2,(a*b)^2,(a*c^-1)^2,(d*a)^3,(b*c^-1*b*c),
(a*d*b)^2,(a*d*c^-1*a*d*c^-1*a*d*a*c*d*c^-1),
(c*d*c*a*d*c^-1*a*d*c*d*c^-1*d),x^a=x*y*z,
x^b=x*u*v,x^c=x*y*z*w*k,x^d=x*z*w,y^a=z,
y^b=y*w,y^c=y*z*u,y^d=z*u*v>;
#G;

/* now we show that G1 is isomorphic to the
mixed extension of  $2^2$  by  $(M(12))$  given abvoe. */

f1,g1,k1:=CosetAction(G,sub<G/Id(G)>);
IsIsomorphic(g1,G1);

/* Thus, G1 is isomorphic  $(2^2 : M(12))$  */

```



## Appendix R

# MAGMA Code for Isomorphism Type of $2^6 : \bullet S_4$

*/\* Consider the subgroup G1 of S\_16 below. We will show that N  
is isomorphic to the mixed extension of 2^6 by S\_4.\*/*

```

S1:=Sym(16);
jj:=S1!(1, 5, 2, 6)(3, 7, 4, 8)(9, 14, 10, 13)
    (11, 16, 12, 15);
kk:=S1!(1, 9, 2, 10)(3, 11, 4, 12)(5, 13, 6,
    14)(7, 15, 8, 16);
ll:=S1!(5, 8)(6, 7)(9, 11)(10, 12)(13, 14)
    (15, 16);
mm:=S1!(1, 2)(3, 4)(5, 6)(7, 8)(9, 10)(11, 12)
    (13, 14)(15, 16);
nn:=S1!(1, 3)(2, 4)(5, 6)(7, 8)(13, 16)(14, 15);
H:=sub<S1|jj,kk,ll,mm,nn>;
G<a,b,c,d,e,t>:=Group<a,b,c,d,e,t|a^4,b^4,c^2,d^2,e^2,
((a^-2)*d),((b^-1)*(a^2)*(b^-1)),((a^-1)*(b^-1)*a*(b^-1))
,((a^-1)*c*(a^-1)*e),((b^-1)*c*b*e),(c*e)^2,t^2,(t,c),
(a*c*e*b^-1*t)^3,(a*t^b)^8,(b*t^a)^3>;
f,G1,k:=CosetAction(G,sub<G|a,b,c,d,e>);
#G1, #k;

/* We will find the Isomorphism type of G1 = 1536 */
Center(G1);
CompositionFactors(G1);
NL:=NormalLattice(G1);
NL;
```

```

/* We will search for the largest Abelian subgroup of G1,
NL[i], using the normal subgroup lattice NL */

for i in [1..16] do if IsAbelian(NL[i]) then i; end if;
end for;

/* Thus, NL[9] is the largest Abelian subgroup of G1.
We factor G1 by NL[9], and call it q. Since
Center(G1) < NL[9], G1 is a mixed extension of NL[9] by
q, the factor group G1/NL[9]. We now find isomorphism
types and presentations of NL[9] and q. */
/* We show below that NL[9] is isomorphic to 2^6 */
NL[9];
m:=AbelianGroup(GrpPerm, [2,2,2,2,2,2]);
IsIsomorphic(m,NL[9]);
/* NL[9] is generated by x,y,z,w,u and v given below. */
NL[9] eq sub<NL[9]|NL[9].1,NL[9].2,NL[9].3,NL[9].4,
NL[9].5,NL[9].6>;
x:=NL[9].1;
y:=NL[9].2;
z:=NL[9].3;
w:=NL[9].4;
u:=NL[9].5;
v:=NL[9].6;
x*y eq y*x;
x*y;
/* A presentation of NL[9] is {x,y,z,w,u,v|x^2,y^2,
z^2,w^2,u^2,v^2,(x,y),(x,z),(x,w),(x,u),(x,v),(y,z),
(y,w),(y,u),(y,v),(z,w),(z,u),(z,v),(w,u),(w,v),
(u,v)}.*/
/* We factor G1 by N[9] and find the generators
of q a presentation for q.*/
q,ff:=quo<G1|NL[9]>;
q;
q eq sub<q|q.1,q.2,q.6>;
Order( sub<q|q.1,q.2,q.6>);
IsIsomorphic(Sym(4),q);
/*
true Isomorphism of GrpPerm: , Degree 4,
Order 2^3 * 3 into GrpPerm: q, Degree 4,
Order 2^3 * 3 induced by
(1, 2, 3, 4) |--> (1, 2, 3, 4)
(1, 2) |--> (1, 2)
*/

```

```

/* q eq sub<q/q.1,q.2,q.6>*/
/* We show below that q is isomorphic to (S_4).*/

HH<a,b,c>:=Group<a,b,c/a^2,b^2,c^2,(a*b)^2,(a*c)^4,
(c*b)^3,(b*a*c*b*a*c*a*b*c)>;
#HH;
f,h2,k:=CosetAction(HH,sub<HH/Id(HH)>);
IsIsomorphic(h2,q);

/* We now see if the generators and relations of q
can be expressed in terms of nonidentity elements
of NL[9]. */
T:=Transversal(G1,NL[9]);
q,ff:=quo<G1/NL[9]>;
ff(T[2]) eq q.1;
ff(T[3]) eq q.2;
ff(T[4]) eq q.6;
A:=T[2];
B:=T[3];
C:=T[4];

ff(A*B) eq q.1*q.2;
ff(A*C) eq q.1*q.6;
ff(B*C) eq q.2*q.6;

Order(A) eq Order(q.1);
Order(B) eq Order(q.2);
Order(C) eq Order(q.6);
Order(A*B) eq Order(q.1*q.2);
Order(A*C) eq Order(q.1*q.6);
Order(B*C) eq Order(q.2*q.6);
/*
Order(A) eq Order(q.1);false
Order(B) eq Order(q.2);false
Order(C) eq Order(q.6);true
Order(A*B) eq Order(q.1*q.2);false
Order(A*C) eq Order(q.1*q.6);false
Order(B*C) eq Order(q.2*q.6);true */

/* The computation above demonstrates, it is possible.
Thus G1 is a mixed extension product of NL[9] by q;
that is, 2^6 by (S_4). Thus G1 is isomorphic
to (2^6:. S_4). */

```

*/\* we now determine the action of q on NL[9], and using  
 Transversal of NL[9] instead of the elements of q  
 and write the generatr elements of S\_4 in terms of 2^6. \*/*

```
for i,j,l,m,n,o in [1..2] do if x^A eq x^i*y^j*z^l
*w^m*u^n*v^o then i,j,l,m,n,o; end if; end for;
for i,j,l,m,n,o in [1..2] do if x^B eq x^i*y^j*z^l
*w^m*u^n*v^o then i,j,l,m,n,o; end if; end for;
for i,j,l,m,n,o in [1..2] do if x^C eq x^i*y^j*z^l
*w^m*u^n*v^o then i,j,l,m,n,o; end if; end for;
```

```
for i,j,l,m,n,o in [1..2] do if y^A eq x^i*y^j
*z^l*w^m*u^n*v^o then i,j,l,m,n,o; end if; end for;
for i,j,l,m,n,o in [1..2] do if y^B eq x^i*y^j
*z^l*w^m*u^n*v^o then i,j,l,m,n,o; end if; end for;
for i,j,l,m,n,o in [1..2] do if y^C eq x^i*y^j
*z^l*w^m*u^n*v^o then i,j,l,m,n,o; end if; end for;
```

```
for i,j,l,m,n,o in [1..2] do if z^A eq x^i*y^j
*z^l*w^m*u^n*v^o then i,j,l,m,n,o; end if; end for;
for i,j,l,m,n,o in [1..2] do if z^B eq x^i*y^j
*z^l*w^m*u^n*v^o then i,j,l,m,n,o; end if; end for;
for i,j,l,m,n,o in [1..2] do if z^C eq x^i*y^j
*z^l*w^m*u^n*v^o then i,j,l,m,n,o; end if; end for;
```

```
for i,j,l,m,n,o in [1..2] do if w^A eq x^i*y^j
*z^l*w^m*u^n*v^o then i,j,l,m,n,o; end if; end for;
for i,j,l,m,n,o in [1..2] do if w^B eq x^i*y^j
*z^l*w^m*u^n*v^o then i,j,l,m,n,o; end if; end for;
for i,j,l,m,n,o in [1..2] do if w^C eq x^i*y^j
*z^l*w^m*u^n*v^o then i,j,l,m,n,o; end if; end for;
```

```
for i,j,l,m,n,o in [1..2] do if u^A eq x^i*y^j
*z^l*w^m*u^n*v^o then i,j,l,m,n,o; end if; end for;
for i,j,l,m,n,o in [1..2] do if u^B eq x^i*y^j
*z^l*w^m*u^n*v^o then i,j,l,m,n,o; end if; end for;
for i,j,l,m,n,o in [1..2] do if u^C eq x^i*y^j
*z^l*w^m*u^n*v^o then i,j,l,m,n,o; end if; end for;
```

```
for i,j,l,m,n,o in [1..2] do if v^A eq x^i*y^j
*z^l*w^m*u^n*v^o then i,j,l,m,n,o; end if; end for;
for i,j,l,m,n,o in [1..2] do if v^B eq x^i*y^j
*z^l*w^m*u^n*v^o then i,j,l,m,n,o; end if; end for;
```

```
for i,j,l,m,n,o in [1..2] do if v^C eq x^i*y^j
*z^l*w^m*u^n*v^o then i,j,l,m,n,o; end if; end for;
```

```
for i,j,l,m,n,o in [1..2] do if A^2 eq x^i*y^j*z^l
*w^m*u^n*v^o then i,j,l,m,n,o; end if; end for;
for i,j,l,m,n,o in [1..2] do if B^2 eq x^i*y^j*z^l
*w^m*u^n*v^o then i,j,l,m,n,o; end if; end for;
for i,j,l,m,n,o in [1..2] do if C^2 eq x^i*y^j*z^l
*w^m*u^n*v^o then i,j,l,m,n,o; end if; end for;
for i,j,l,m,n,o in [1..2] do if (A*B)^2 eq x^i*y^j
*z^l*w^m*u^n*v^o then i,j,l,m,n,o; end if; end for;
for i,j,l,m,n,o in [1..2] do if (A*C)^4 eq x^i*y^j
*z^l*w^m*u^n*v^o then i,j,l,m,n,o; end if; end for;
for i,j,l,m,n,o in [1..2] do if (C*B)^3 eq x^i*y^j
*z^l*w^m*u^n*v^o then i,j,l,m,n,o; end if; end for;
for i,j,l,m,n,o in [1..2] do if (B*A*C*B*A*C*A*B*C)
eq x^i*y^j*z^l*w^m*u^n*v^o then i,j,l,m,n,o; end if;
end for;
```

```
/* Here is a presentation for the mixed extension of 2^6 by S_4. */
```

```
G<x,y,z,w,u,v,a,b,c>:=Group<x,y,z,w,u,v,a,b,c/x^2,y^2,z^2,
w^2,u^2,v^2,(x,y),(x,z),(x,w),(x,u),(x,v),(y,z),(y,w),(y,u),
(y,v),(z,w),(z,u),(z,v),(w,u),(w,v),(u,v),a^2=w,b^2=w,c^2,
(a*b)^2=w,(a*c)^4=w*u,(c*b)^3,(b*a*c*b*a*c*a*b*c)=u*v,x^a=x*y,
x^b=x*y*w,x^c=x,y^a=y,y^b=y,y^c=z,z^a=z*v,z^b=y*z,z^c=y,
w^a=w,w^b=w,w^c=u,u^a=u,u^b=w*u,u^c=w,v^a=v,v^b=v,v^c=v>;
#G;
```

```
/* now we show that G1 is isomorphic to the mixed extension
of 2^6 by S_4 given above. */
```

```
f1,g1,k1:=CosetAction(G,sub<G/Id(G)>);
IsIsomorphic(g1,G1);
```

```
/* Thus, G1 is isomorphic (2^6 :. S_4) */
```

## Appendix S

### MAGMA Code for Isomorphism

#### Type of 2 : $S_7$

```

S1:=Sym(6);
ff:=S1!(1, 2)(3, 5)(4, 6);
gg:=S1!(1, 2)(3, 4)(5, 6);
hh:=S1!(1, 3, 6)(2, 4, 5);
H:=sub<S1|ff,gg,hh>;
G<a,b,c,t>:=Group<a,b,c,t/a^2,b^2,c^3,(a*b)^2,
(a*(c^-1))^2,(b*(c^-1)*b*c),t^2,(t,a*b),(a*b*t)^4,
(a*t^c)^6,(c*t)^4,(b*c*t)^7>;
f,G1,k:=CosetAction(G,sub<G/a,b,c>);
#G1, #k;
/* We will find the Isomorphism type of G1 = 10080 */
Center(G1);
CompositionFactors(G1);
NL:=NormalLattice(G1);
NL;
/* We will search for the largest Abelian subgroup
of G1, NL[i], using the normal subgroup lattice NL */

for i in [1..7] do if IsAbelian(NL[i]) then i; end if;
end for;

/* Thus, NL[2] is the largest Abelian subgroup of G1.
We factor G1 by NL[2], and call it q. Since
Center(G1) < NL[2], G1 is a mixed extension of NL[2] by
q, the factor group G1/NL[2]. We now find isomorphism
types and presentations of NL[2] and q. */

```

```

/* We show below that NL[2] is isomorphic to 2 */
NL[2];
m:=AbelianGroup(GrpPerm,[2]);
IsIsomorphic(m,NL[2]);

/* NL[2] is generated by x given below. */
NL[2] eq sub<NL[2]|NL[2].2>;
x:=NL[2].2;
/* A presentation of NL[2] is {x|x^2}.*
/* We factor G1 by N[2] and find the generators of
q a presentation for q.*
q,ff:=quo<G1|NL[2]>;
q;
q eq sub<q|q.1,q.2,q.3,q.4>;
Order( sub<q|q.1,q.2,q.3,q.4>);
/* We show below that q is isomorphic to (S_7).*/

HH<a,b,c,d>:=Group<a,b,c,d/a^2,b^2,c^3,d^2,(a*b)^2,
(a*c^-1)^2,(b*c^-1*b*c),(a*d*b)^2,(c^-1*d)^4,
(d*a*d*a*d*a*d*a*d*b),(c*d*a*d*c^-1*d*a*d)^2,
(a*d*c*a*d*c*a*d*c*a*d*a*c^-1*d*a*c^-1*d*c),
(c*a*d*a*d*c^-1*d*a*d*c^-1*a*d*a*c*d*c^-1*d*c*d*a*d)>;
#HH;
f,h2,k:=CosetAction(HH,sub<HH|Id(HH)>);
IsIsomorphic(h2,q);
IsIsomorphic(Sym(7),q);
/* We now see if the generators and relations of q can
be expressed in terms of nonidentity elements of NL[2].*/
T:=Transversal(G1,NL[2]);
q,ff:=quo<G1|NL[2]>;
ff(T[2]) eq q.1;
ff(T[3]) eq q.2;
ff(T[4]) eq q.3;
ff(T[5]) eq q.4;
A:=T[2];
B:=T[3];
C:=T[4];
D:=T[5];

/* we now determine the action of q on NL[2],
and using Transversal of NL[2] instead of the elements
of q and write the generatrs elements of (S_7) in terms of 2.*

for i in [1..2] do if x^A eq x^i then i; end if; end for;

```

```

for i in [1..2] do if x^B eq x^i then i; end if; end for;
for i in [1..2] do if x^C eq x^i then i; end if; end for;
for i in [1..2] do if x^D eq x^i then i; end if; end for;
/* Here is a presentation for the mixed extension of
2 by (S_7). */
G<x, a, b, c, d>:=Group<x, a, b, c, d/x^2, a^2, b^2, c^3, d^2,
(a*b)^2, (a*c^-1)^2, (b*c^-1*b*c), (a*d*b)^2, (c^-1*d)^4
, (d*a*d*a*d*a*d*a*d*b), (c*d*a*d*c^-1*d*a*d)^2,
(a*d*c*a*d*c*a*d*c*a*d*a*c^-1*d*a*c^-1*d*c),
(c*a*d*a*d*c^-1*d*a*d*c^-1*a*d*a*c*d*c^-1*d*c*d*a*d),
x^a=x, x^b=x, x^c=x, x^d=x>;
#G;

/* now we show that G1 is isomorphic to
the semidirect product of 2 by (S_7) given above. */
f1, g1, k1:=CosetAction(G, sub<G/Id(G)>);
IsIsomorphic(g1, G1);
/* Thus, G1 is isomorphic (2 : S_7) */

```



## *Bibliography*

- [Cur07] *R.T. Curtis*. Symmetric Generation of Groups: With Applications to many of the Sporadic Simple Finite Groups. *Cambridge University Press*, 2007.
- [Gal10] *Joseph A. Gallian*. Contemporary Abstract Algebra. *Brooks/Cole, Cengage Learning*, 2010.
- [Isa76] *M. Isaacs*. Character Theory of Finite Groups. *Dover Publication*, 1976.
- [Kan] *David Kang*. Group representation and character theory. <http://www.math.uchicago.edu/~may/VIGRE/VIGRE2011/REUPapers/KangD.pdf>.
- [Led77] *Walter Ledermann*. Introduction to Group Characters. *Cambridge University Press*, 1977.
- [McK] *James McKernan*. Modern algebra, lecturer notes. <http://ocw.mit.edu/courses/mathematics/18-703-modern-algebra-spring-2013/lecture-notes/>.
- [Mil13] *J.S. Milne*. Group Theory. *Copyright*, 2013.
- [Rot95] *Joseph J Rotman*. An Introduction to the Theory of Groups. *Springer*, 1995.
- [Say05] *Mohamed Sayed*. Double-coset enumeration algorithm for symmetrically generated groups. *International Journal of Mathematics and Mathematical Sciences*, 2005.
- [Wik] *Wikipedia*. Schur multiplier. [http://en.wikipedia.org/wiki/Schur\\_multiplier](http://en.wikipedia.org/wiki/Schur_multiplier).

[WWI] *R Wilson, P Walsh, and Suleiman I. Atlas of finite group representations - version 3. <http://brauer.maths.qmul.ac.uk/Atlas/v3/>.*